

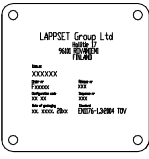

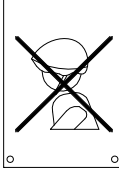

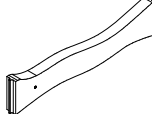

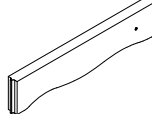



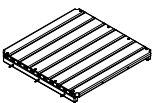

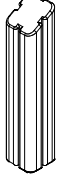
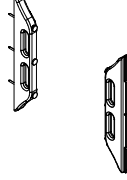





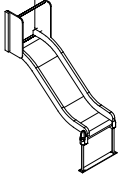

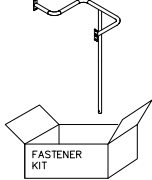
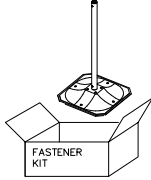

DATE: 19.9.2024

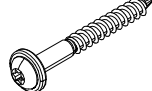
702286  65x65	PCS 1	702339  118x78	PCS 1	705197-001  45x145x724	PCS 1	705211-001  45x145x715	PCS 5	705218-001  70x145x965	PCS 2	705258-001  	PCS 1
705381-001  93x93x450	PCS 1	705506-001  	PCS 1	705511  	PCS 2	705541-001  70x145x770	PCS 2	706192-001  93x93x946	PCS 4	706234-001  	PCS 1
706541  FASTENER KIT	PCS 1	706542  FASTENER KIT	PCS 1	711369-001  93x93x1846	PCS 4	711605  	PCS 1	900240  8x70	PCS 20	901902  30.7x60.9x100	PCS 2
901916  L 650	PCS 1	903093  8x90	PCS 26	905051  Ø24/8,4	PCS 2	905104  M10	PCS 36	907695-216  L 2400	PCS 1	907829-216  L 1454	PCS 1
909230  8x150	PCS 2	909519  50x380x380	PCS 1	909521  	PCS 9	980114  Ø4x20	PCS 8		PCS 2		PCS
	PCS		PCS		PCS		PCS		PCS		PCS
	PCS		PCS		PCS		PCS		PCS		PCS

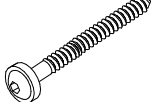
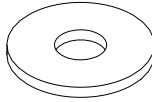
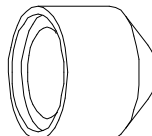
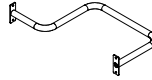
— EN/AS Impact Area 20.2 m²
- - - Falling Space 29.4 m²
Max Falling Height 1000 mm

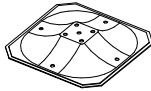
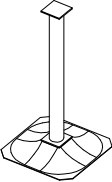

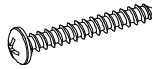
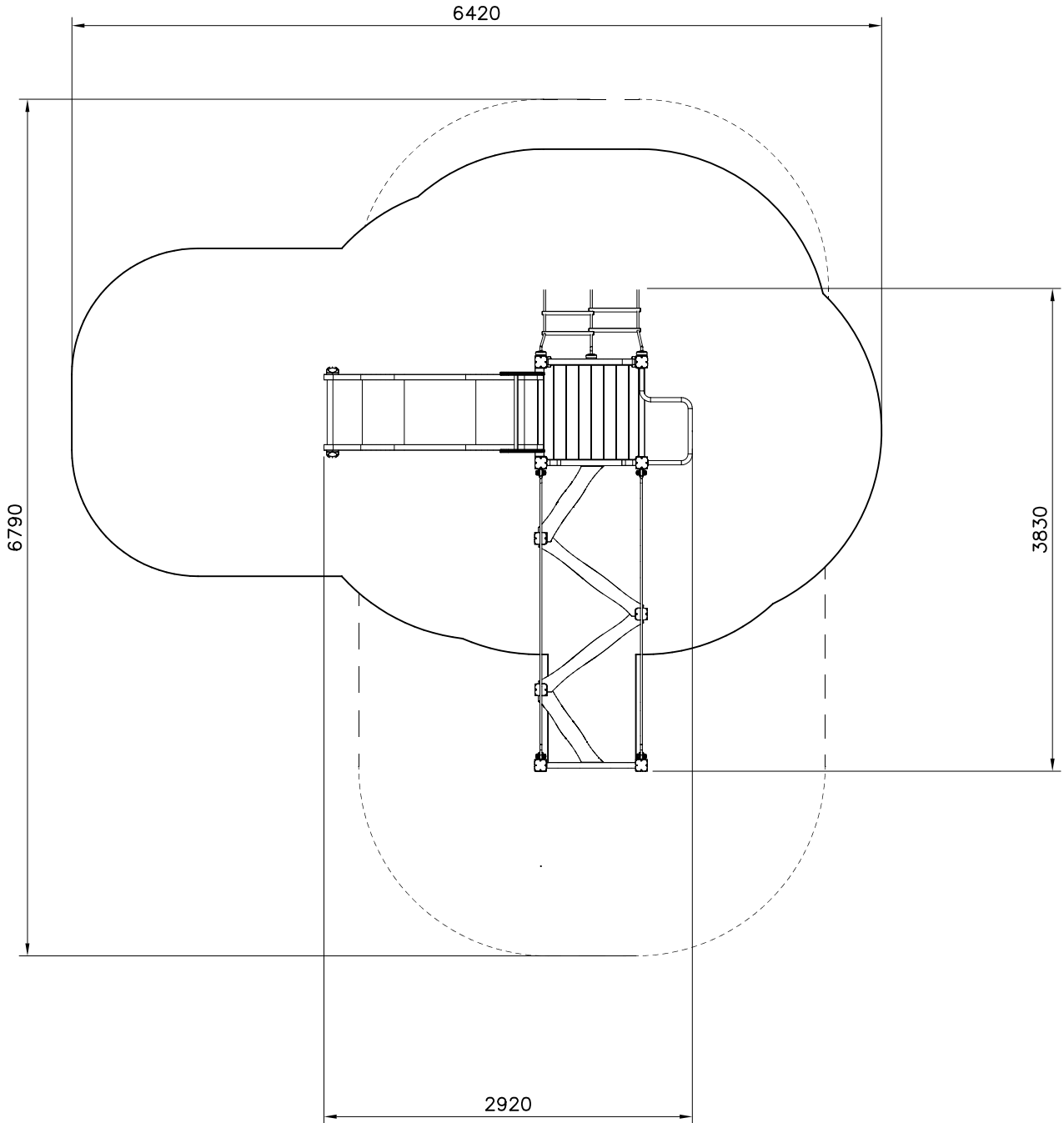
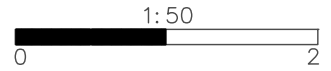
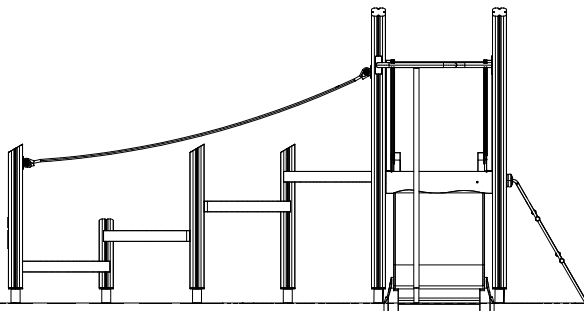
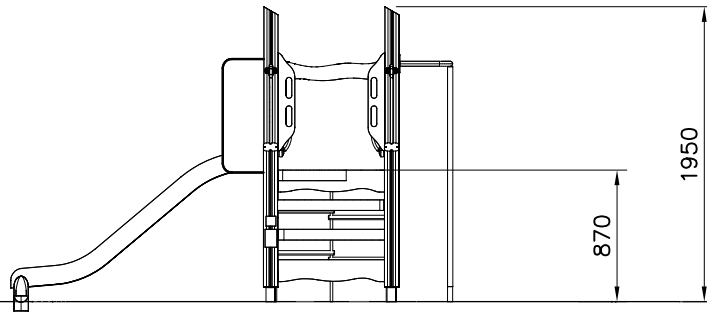

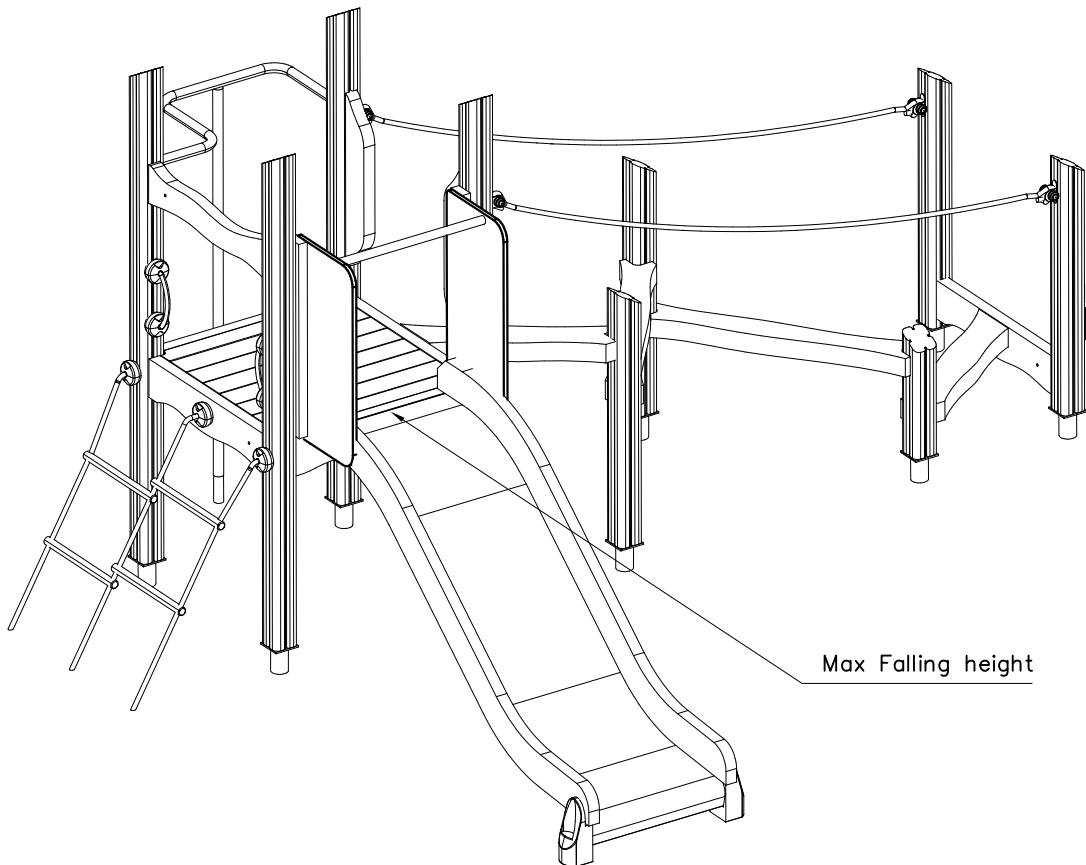
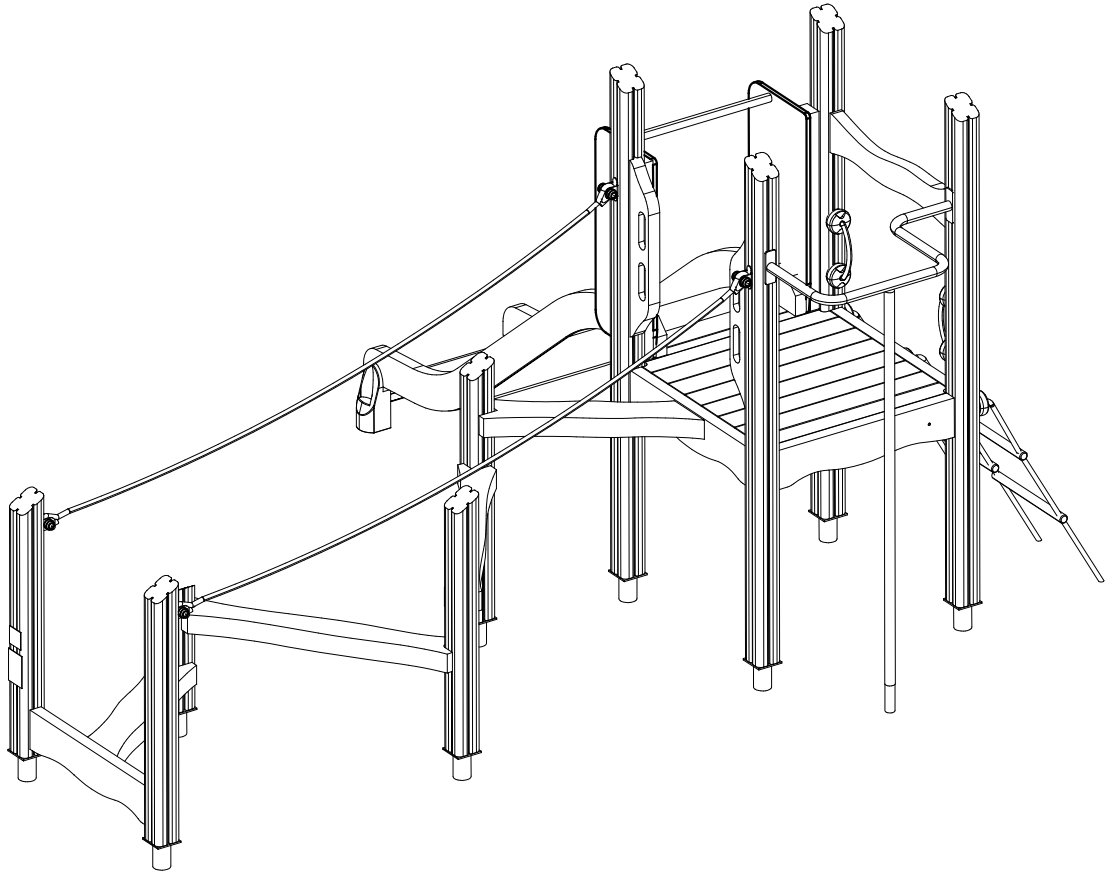

Max Falling height