

Max falling height

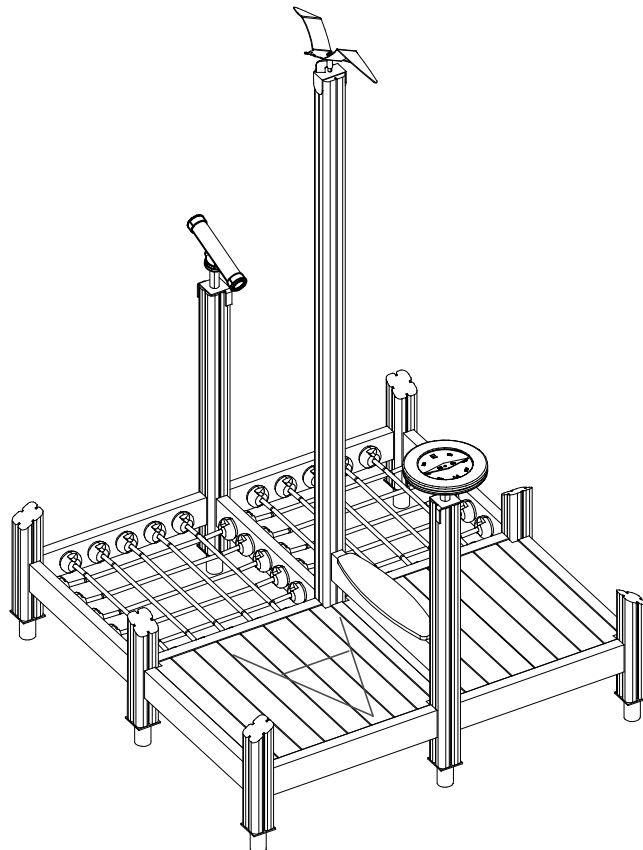

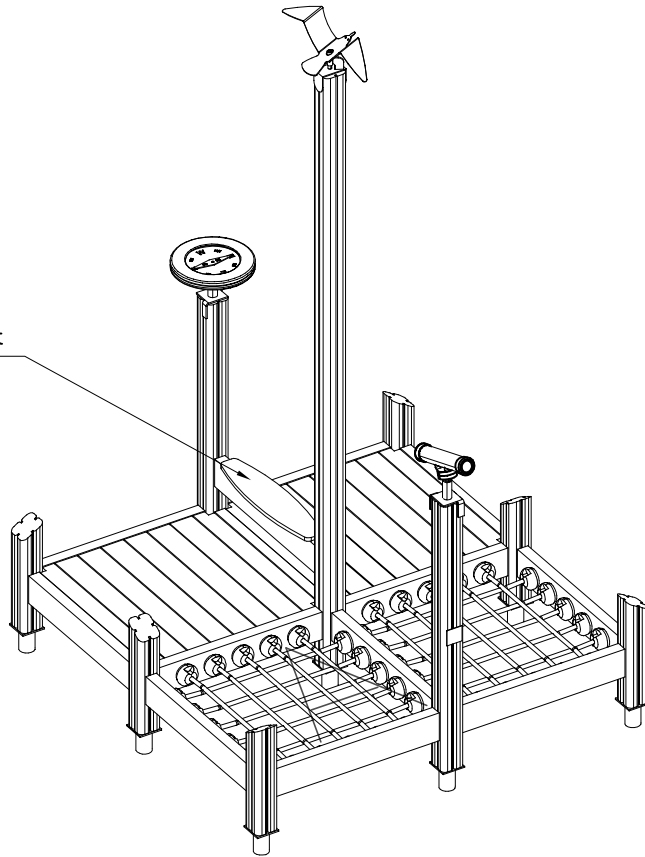

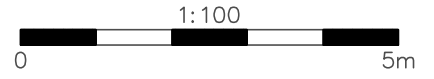

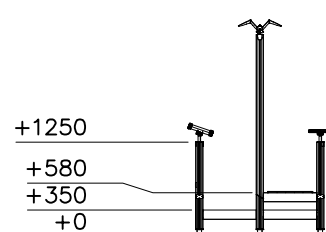
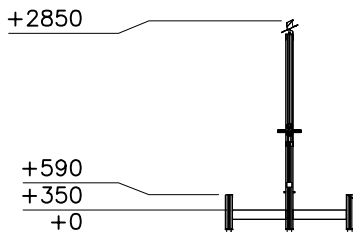
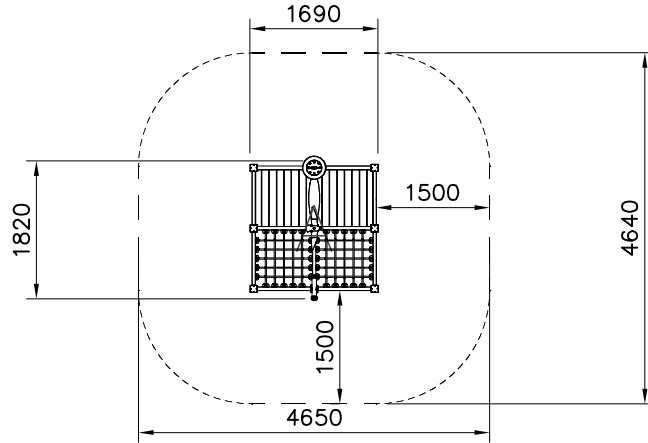



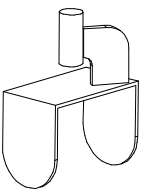

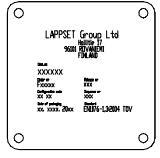
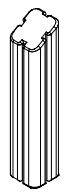
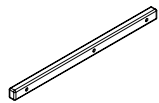
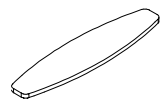

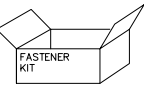
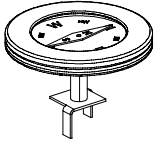
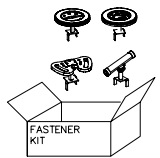
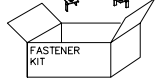
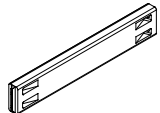

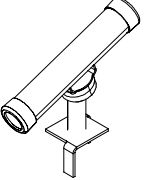

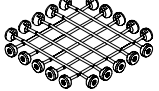
----- Falling Space 19,6 m²
Max Falling Height 590 mm

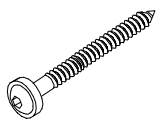
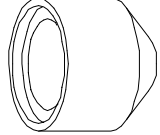
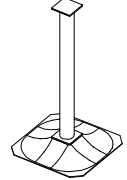

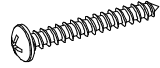
DATE: 15.8.2024

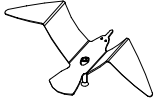
003894  1 	PCS	008986  2 750x750	PCS	702286  1 65x65	PCS	705381-001  6 93x93x450	PCS	706443  4 32x45x702	PCS	706453  1 15x145x600	PCS
706535  2 	PCS	707303-701  1	PCS	707585  1 	PCS	708746-001  13 45x120x724	PCS	709692-001  2 93x93x1150	PCS	709901-001  1 93x93x2570	PCS
711535  1 	PCS	711544  2 	PCS	903093  52 Ø8x90	PCS	905104  36 M10	PCS	909521  9 	PCS	980114  4 Ø4x20	PCS
980123  4 Ø7x60	PCS	PN0487  1	PCS		PCS		PCS		PCS		PCS
	PCS		PCS		PCS		PCS		PCS		PCS
	PCS		PCS		PCS		PCS		PCS		PCS
	PCS		PCS		PCS		PCS		PCS		PCS