

LAPPSET®

FLORA







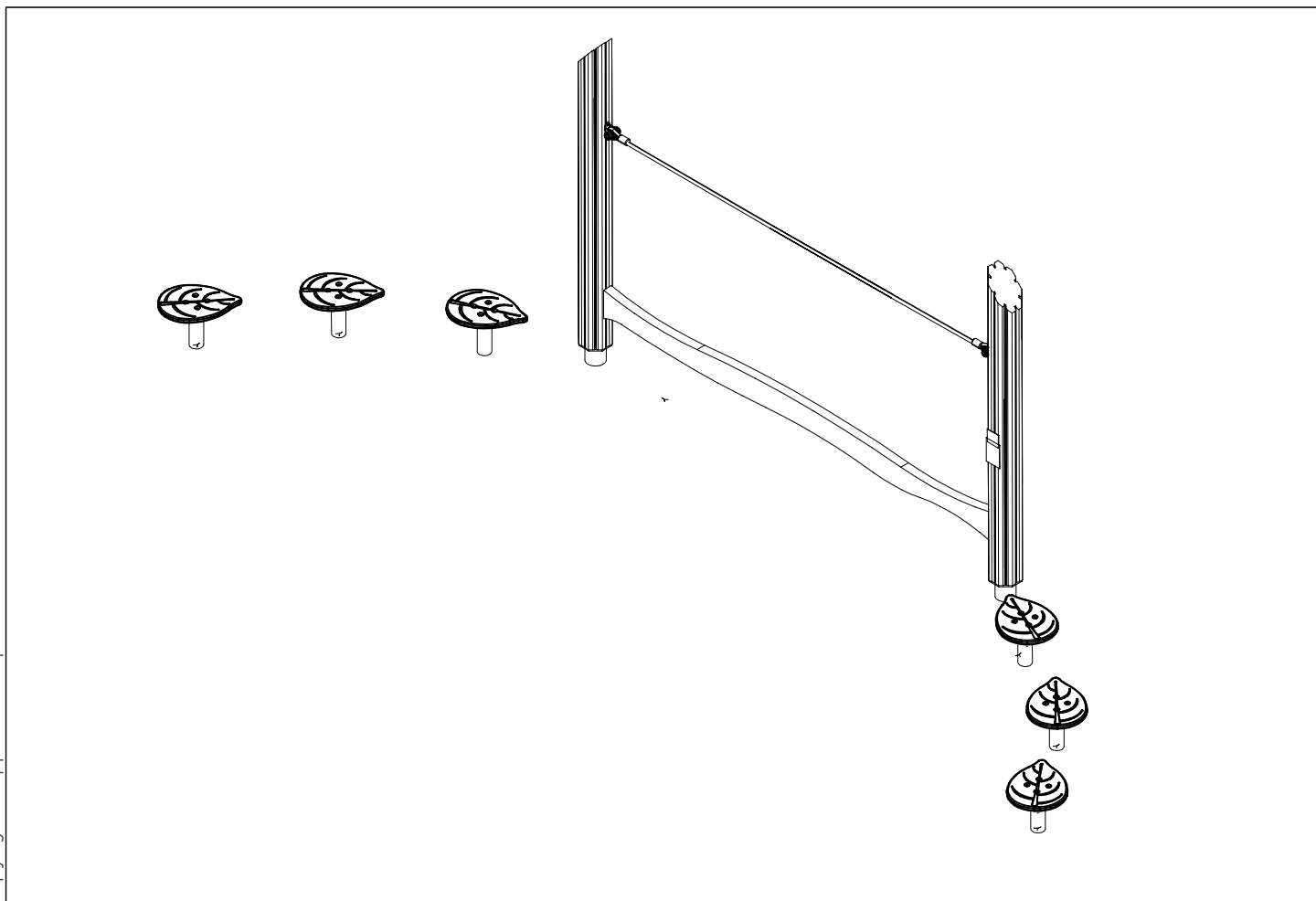

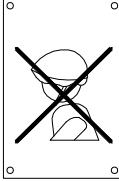

A SENNUSOHJE
MONTERINGSANSVISNING
INSTALLATION INSTRUCTION
AUFBAUANLEITUNG
NOTICE D'INSTALLATION

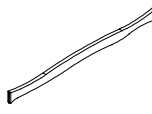
DATE: 20.6.2024

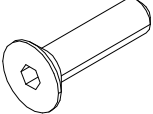
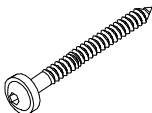
QFL0063

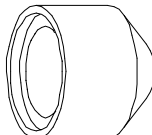
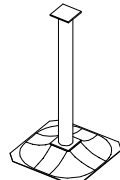

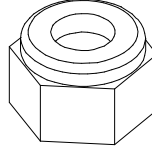
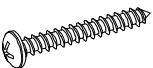
DATE: 20.6.2024

702286  65x65	PCS 1	702339  118x78	PCS 1	705389-001  140x140x1550	PCS 2	705804-001  45x145x2280	PCS 1	711863  	PCS 1	901487  M10x40	PCS 24
903093  Ø8x90	PCS 4	903112  L=750	PCS 2	905104  M10	PCS 40	909521  	PCS 6	909637  Ø20/10,5	PCS 24	980114  Ø4x20	PCS 8
P03805  20x250x350	PCS 6		PCS		PCS		PCS		PCS		PCS
	PCS		PCS		PCS		PCS		PCS		PCS
	PCS		PCS		PCS		PCS		PCS		PCS
	PCS		PCS		PCS		PCS		PCS		PCS
	PCS		PCS		PCS		PCS		PCS		PCS

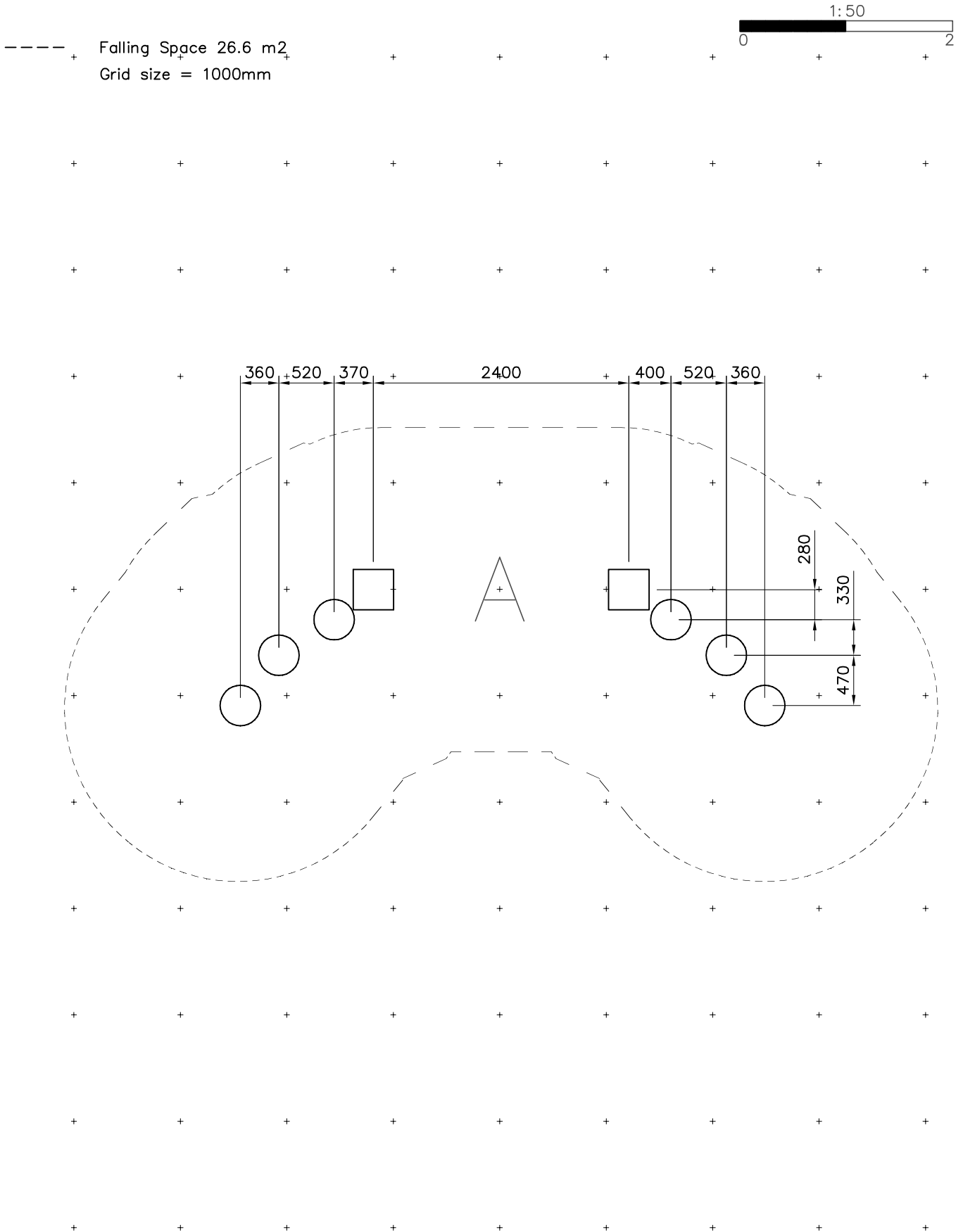

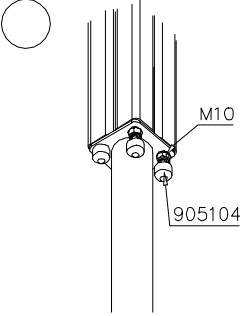
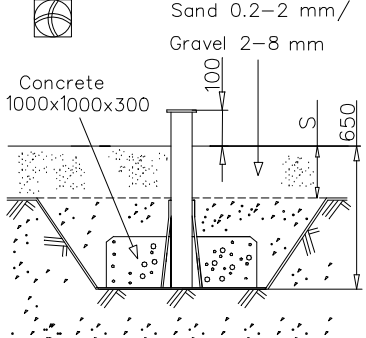
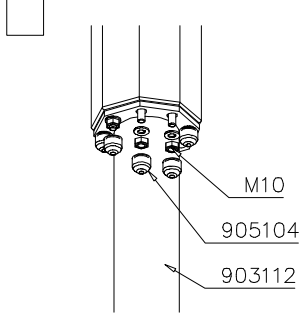
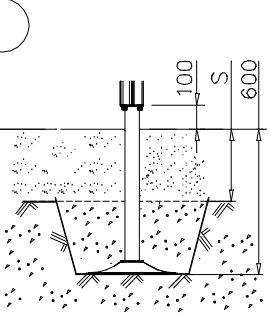
 <p>M10 905104</p>	 <p>Sand 0.2-2 mm/ Gravel 2-8 mm</p> <p>Concrete 1000x1000x300</p> <p>100 650</p>	 <p>M10 905104 903112</p>
 <p>100 600</p>		

----- Falling Space 26.6 m²
Max Falling Height 400 mm

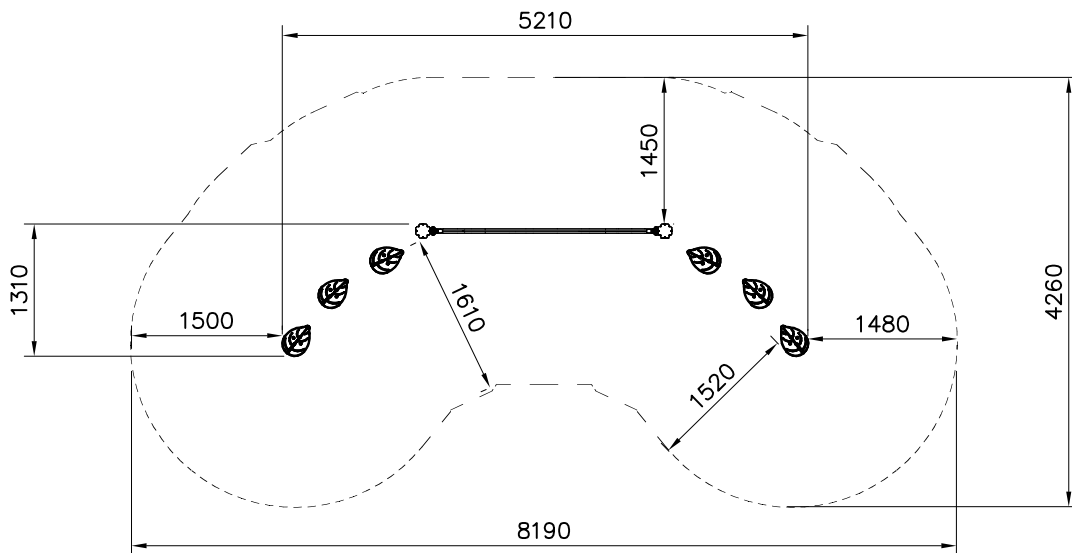
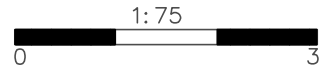

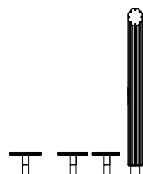
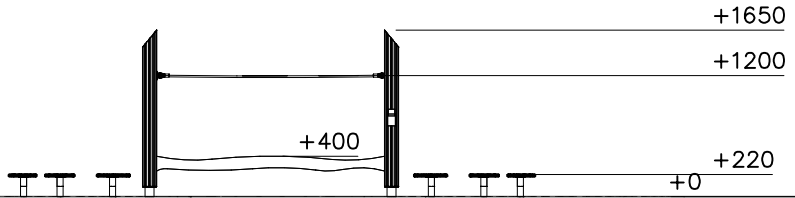

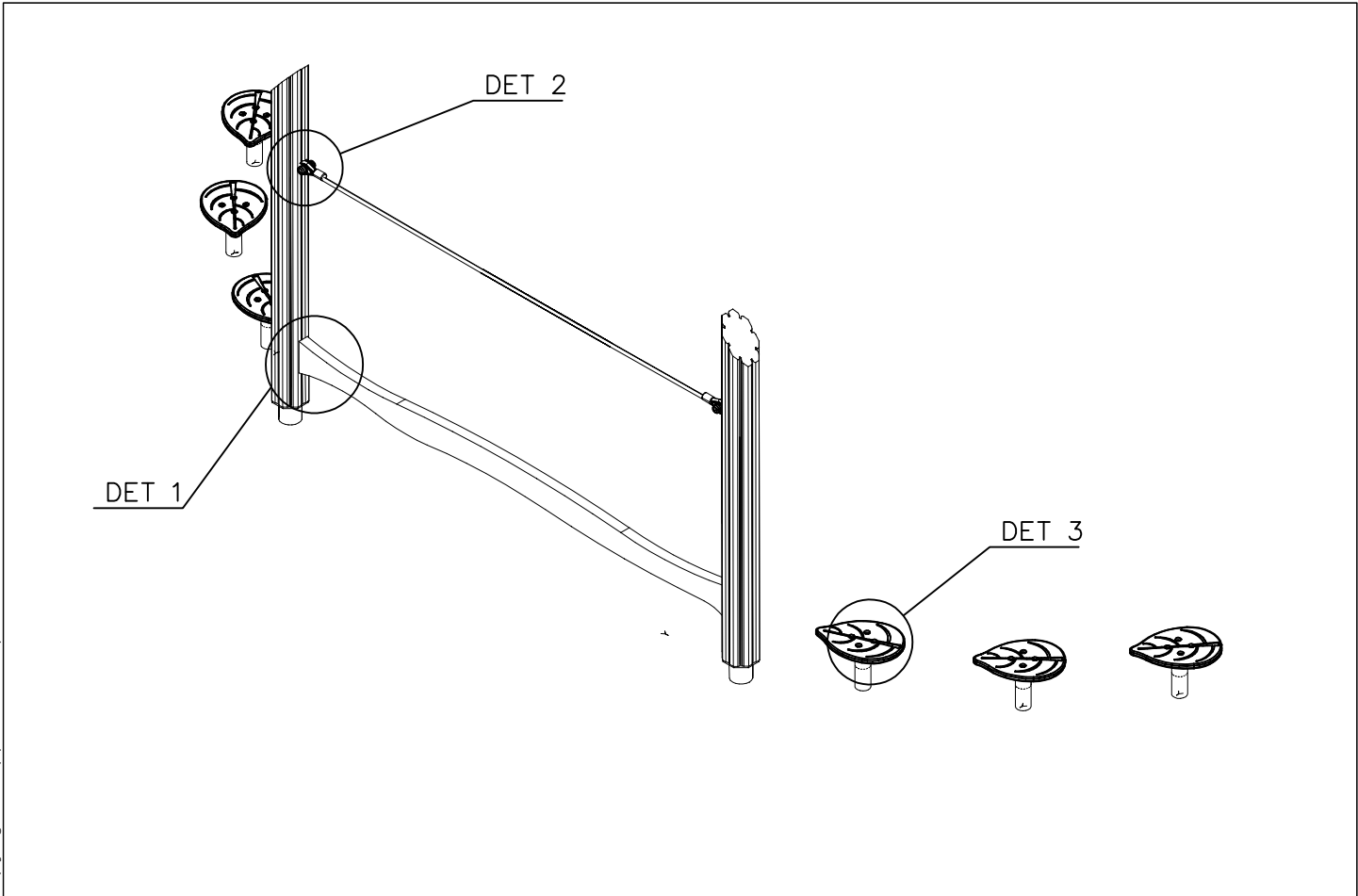
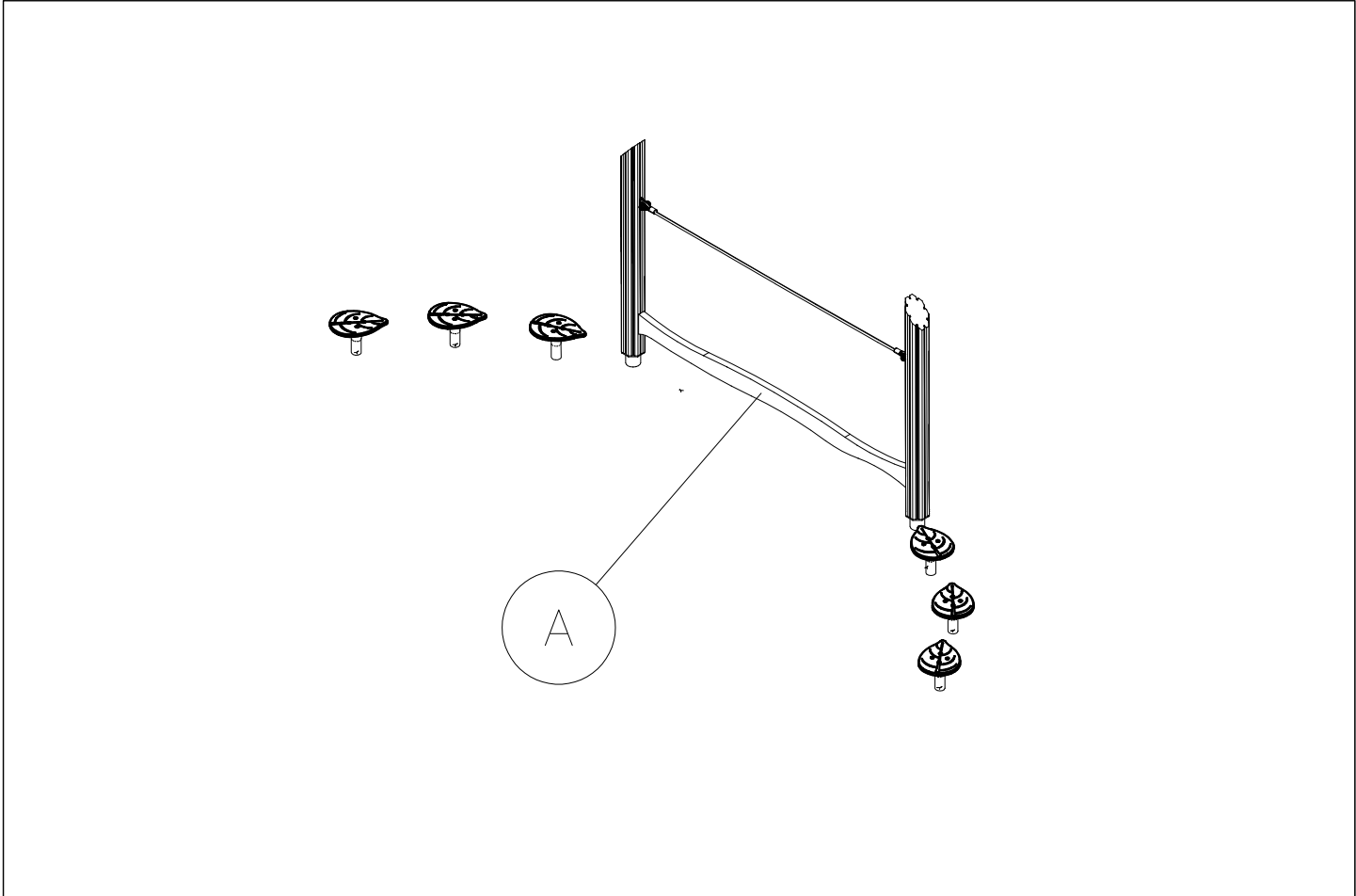

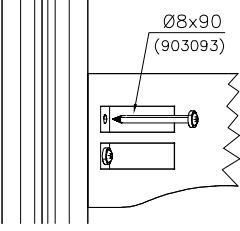
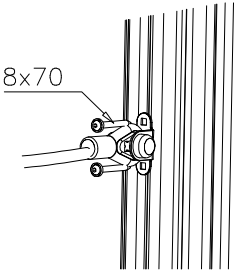
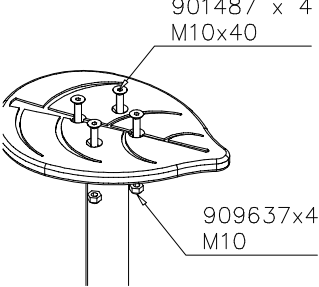
DET 1 	DET 2 	DET 3 	

DATE: 20.6.2024

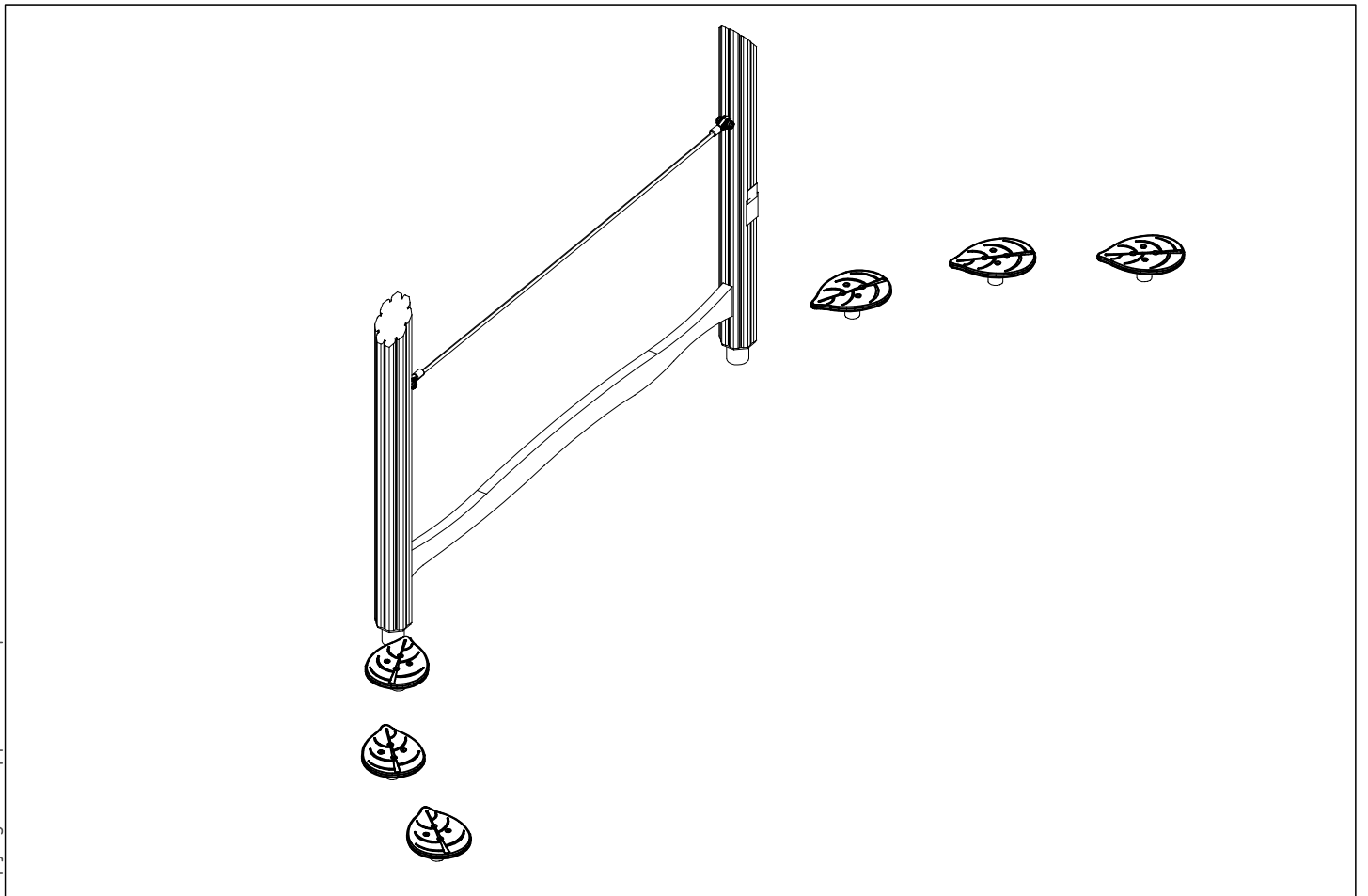
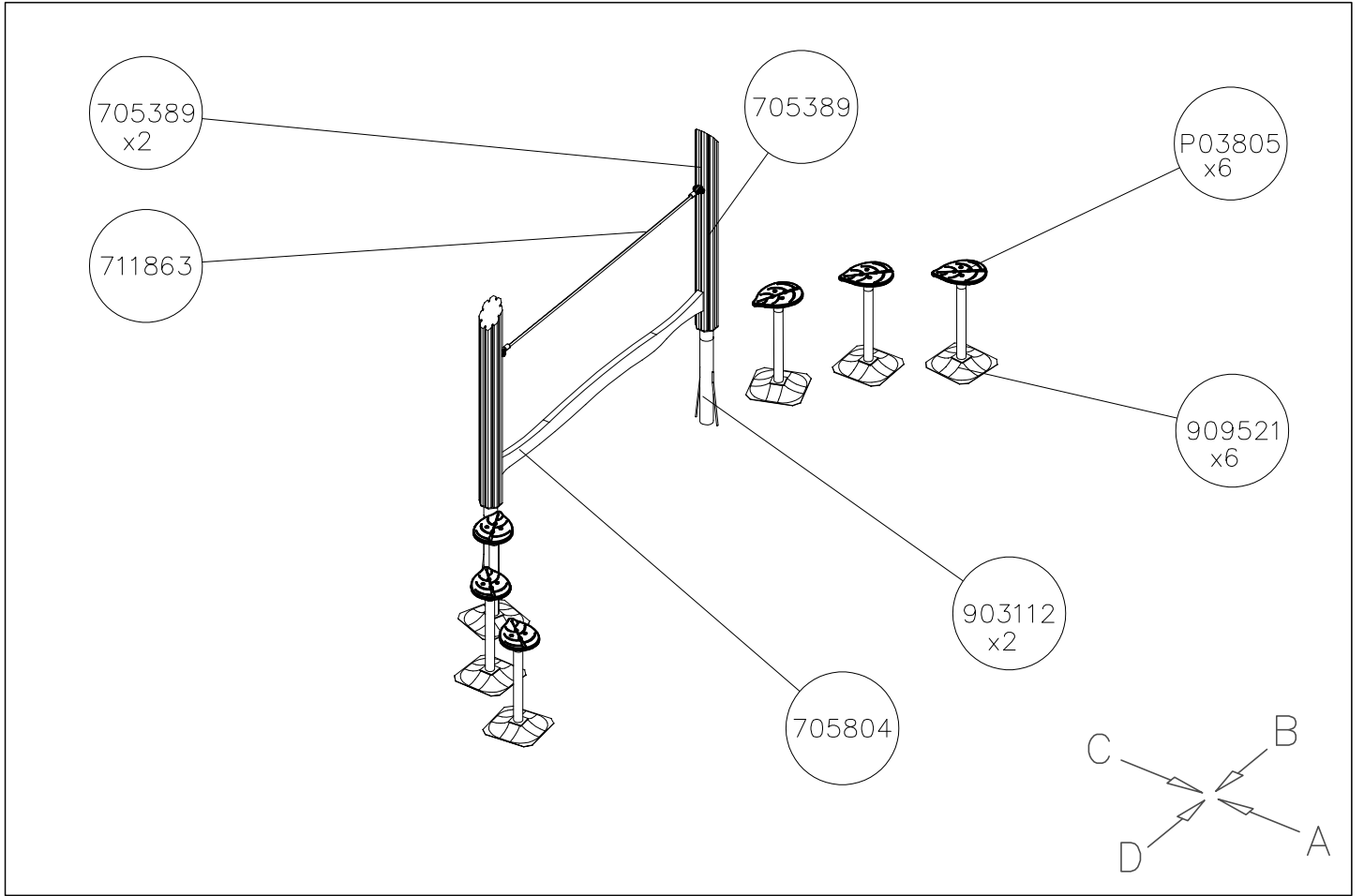

A

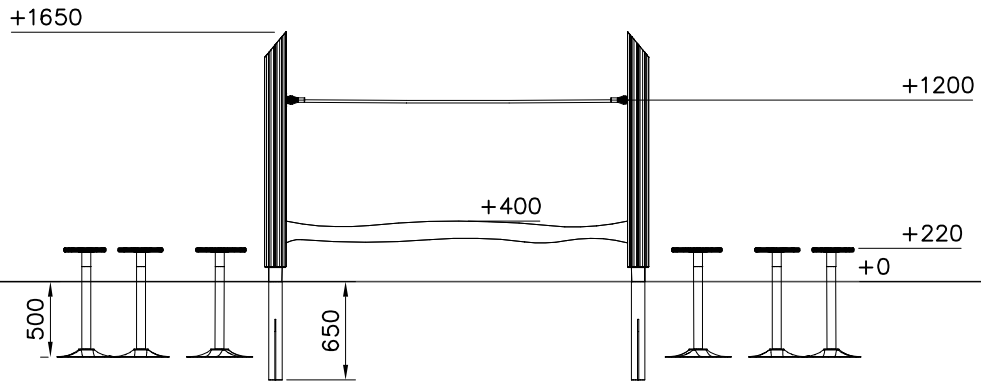

C

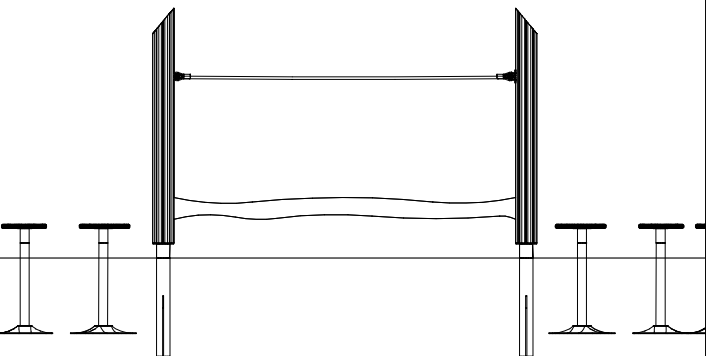

D

