

LAPPSET®

FINNO





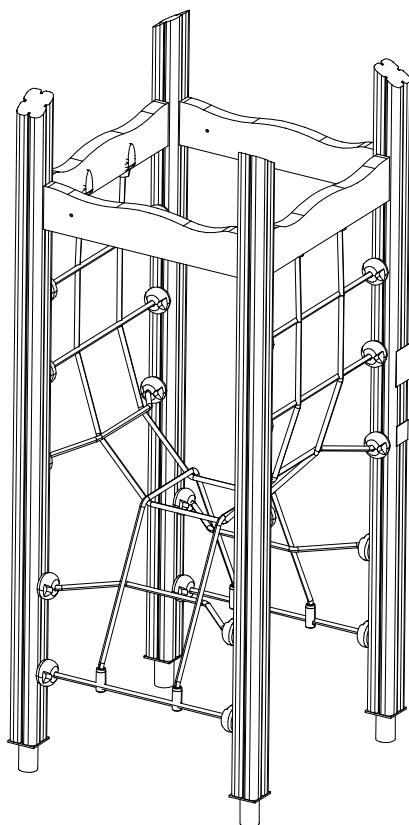

ASENNUSOHJE
MONTERINGSANSVISNING
INSTALLATION INSTRUCTION
AUFBAUANLEITUNG
NOTICE D'INSTALLATION

DATE: 18.7.2024

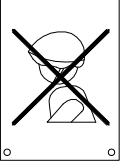
QFL0057

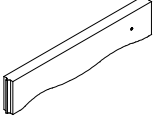
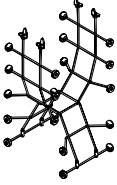
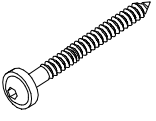

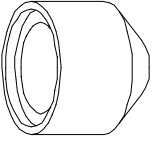
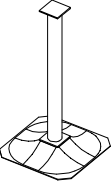
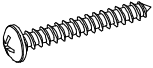
DATE: 18.7.2024

702286	PCS	702339	PCS	705206-001	PCS	705211-001	PCS	711507	PCS	903093	PCS
	1		1		4		4		1		16
65x65		118x78		93x93x2146		45x145x724				Ø8x90	
905104	PCS	909521	PCS	980114	PCS		PCS		PCS		PCS
	16		4		8						
M10				Ø4x20							
	PCS		PCS		PCS		PCS		PCS		PCS
	PCS		PCS		PCS		PCS		PCS		PCS
	PCS		PCS		PCS		PCS		PCS		PCS
	PCS		PCS		PCS		PCS		PCS		PCS

- EN/AS Impact Area 17.3 m²
- - - - Falling Space 17.3 m²
- Max Falling Height 1960 mm

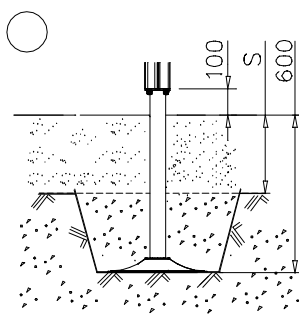
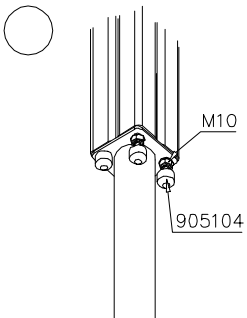
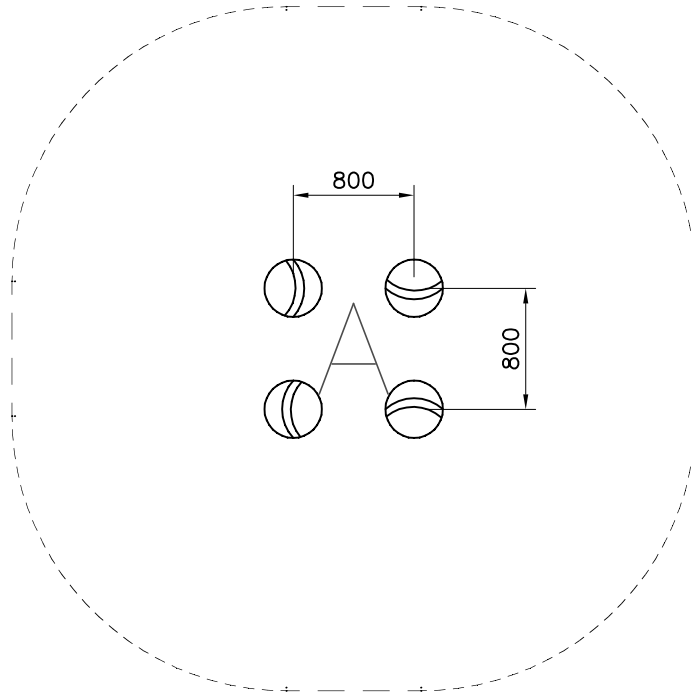
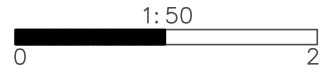

- EN/AS Impact Area 17.3 m²
- - - Falling Space 17.3 m²
Max Falling Height 1960 mm

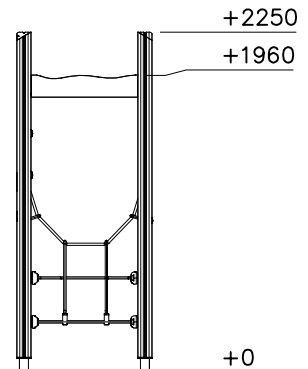
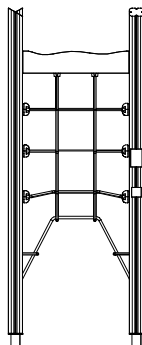
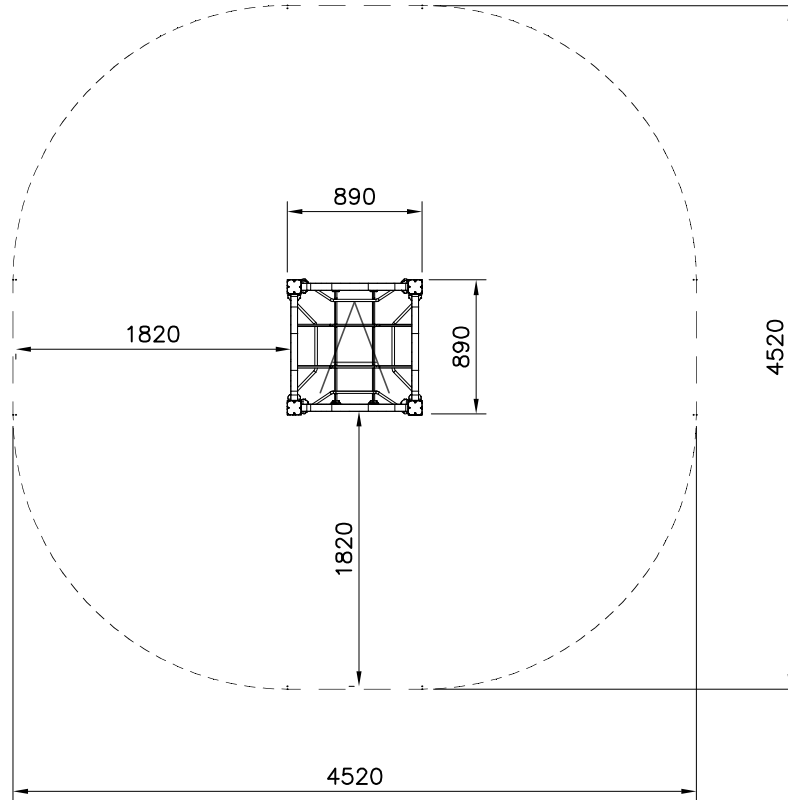
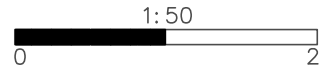

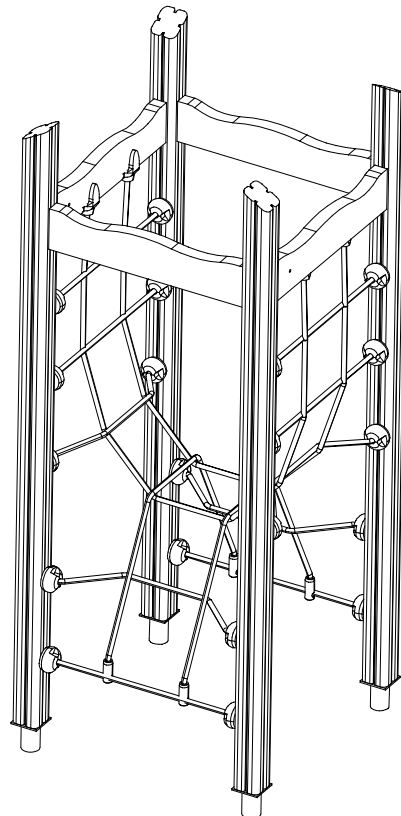
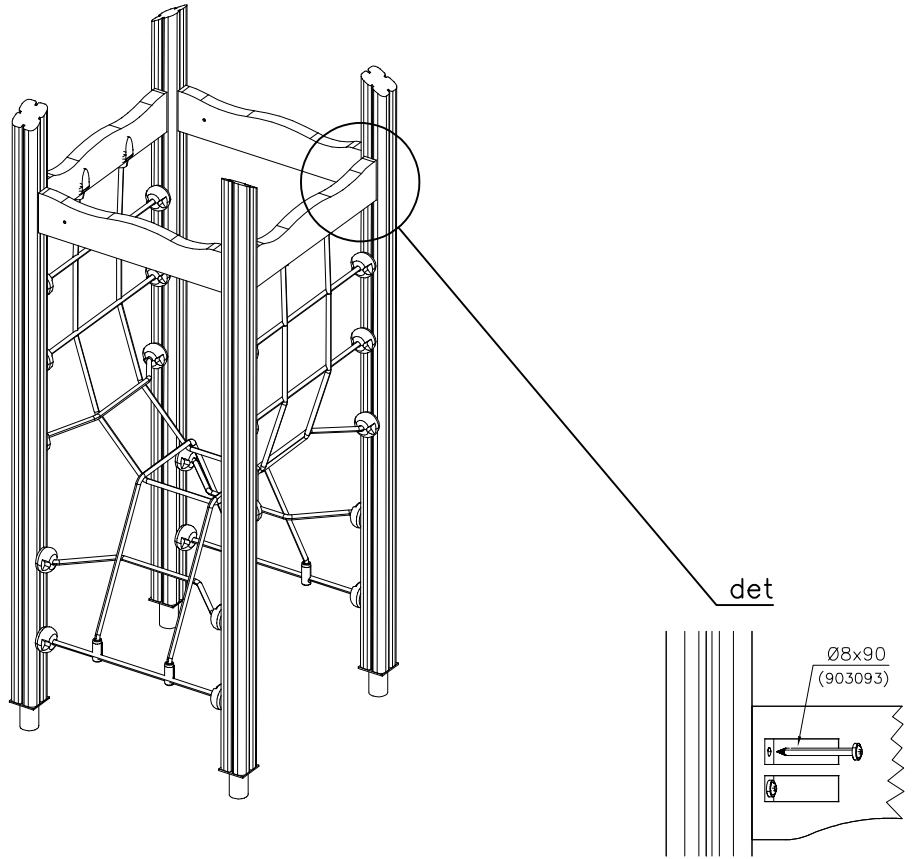

DATE: 18.7.2024

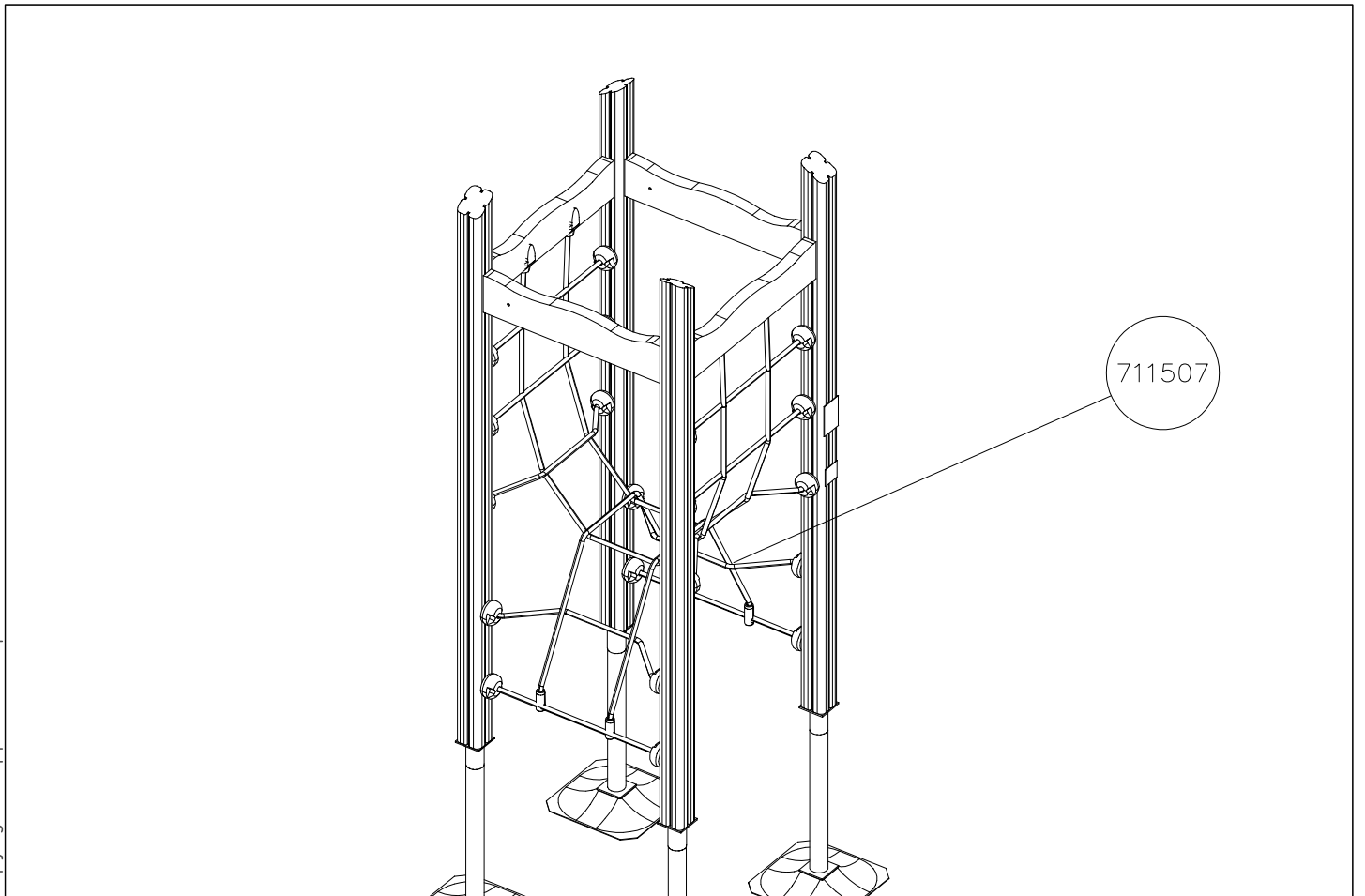
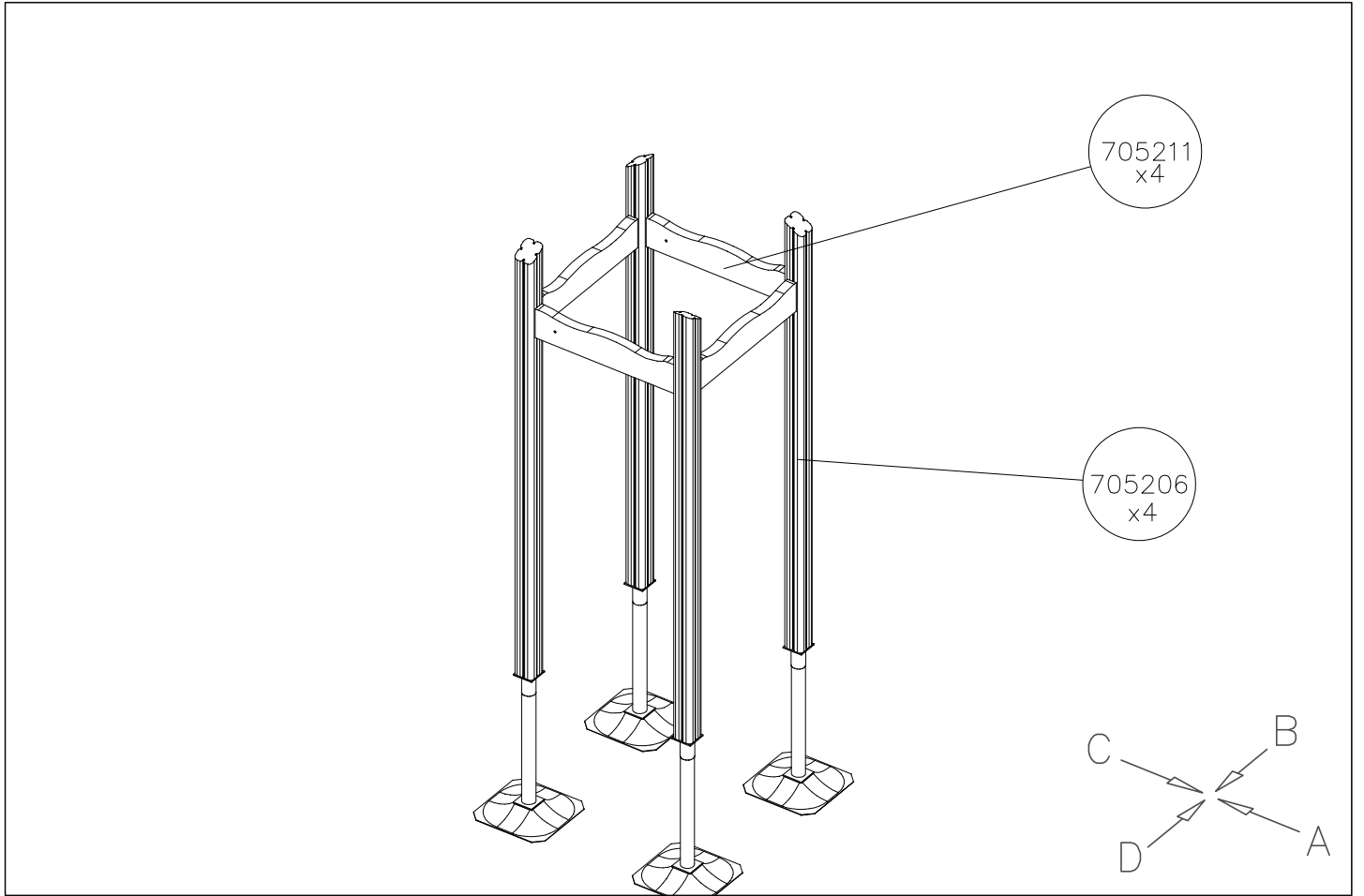

DATE: 18.7.2024

1:50

(B)

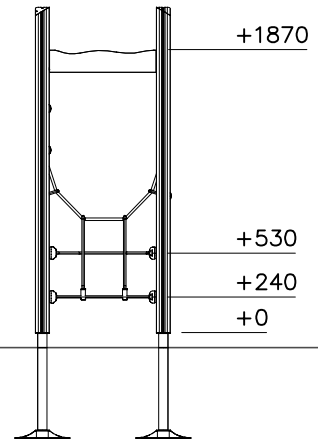
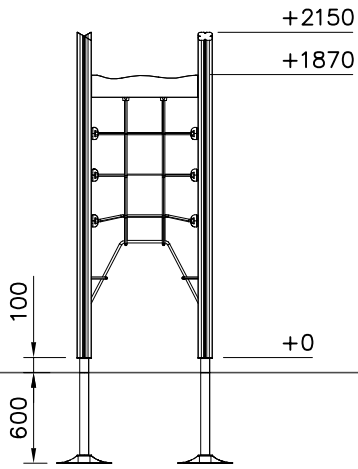

(C)

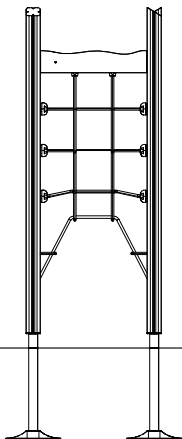

(D)

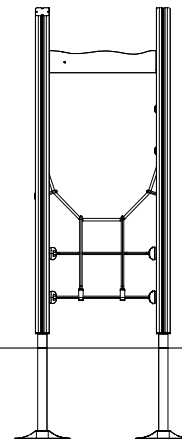

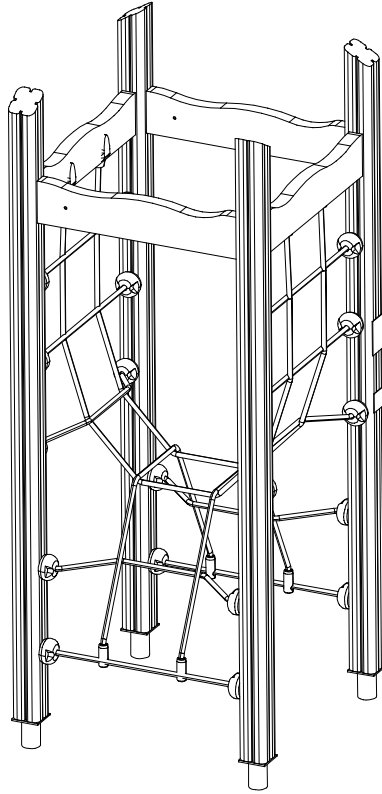

Max Falling Height 1960 mm

