

LAPPSET®

FINNO







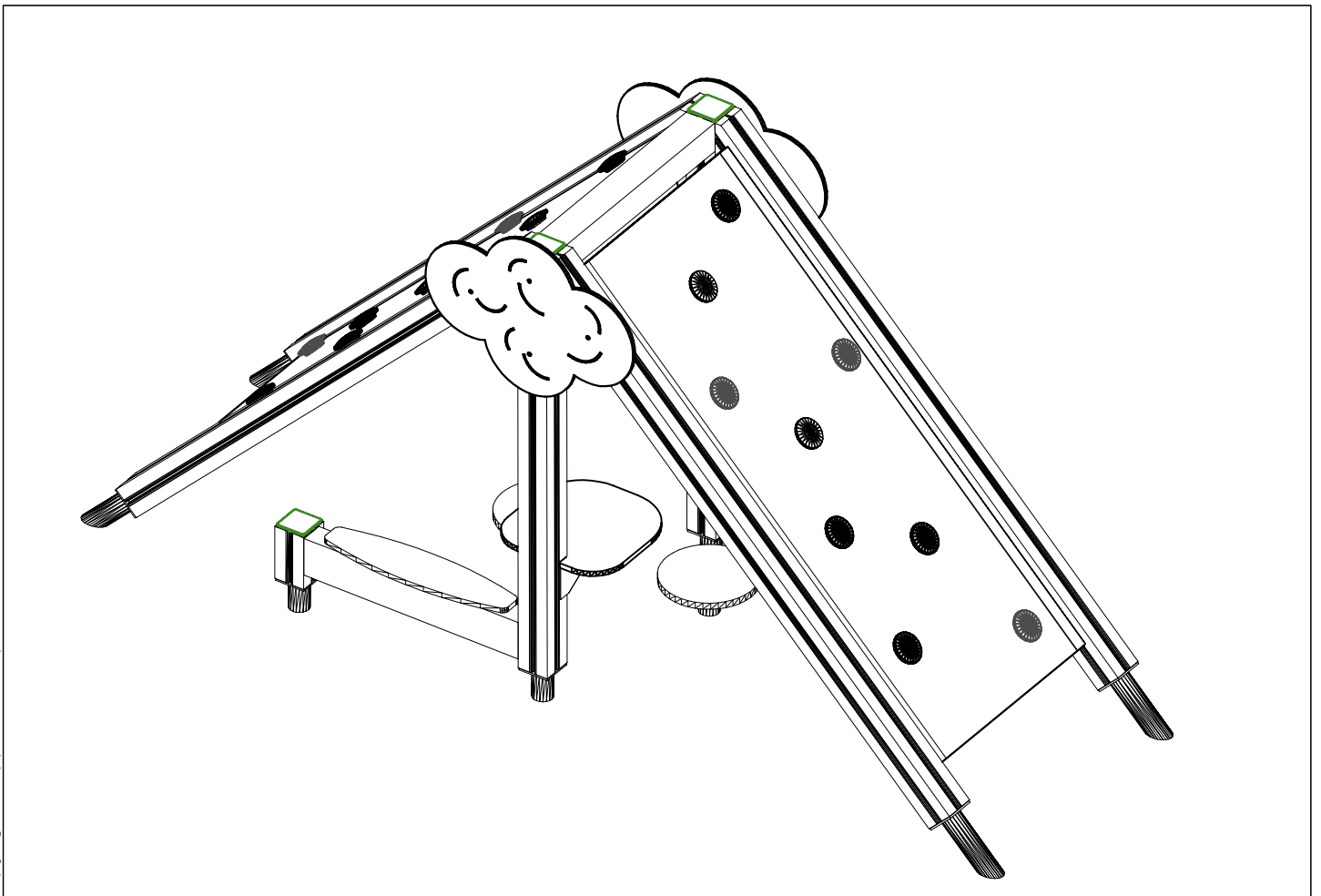



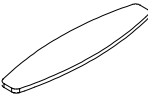
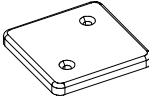
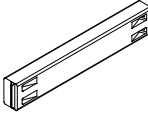
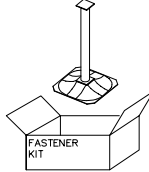
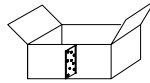

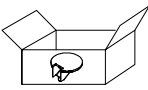
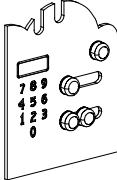
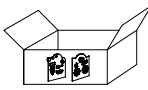

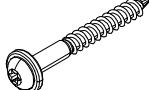
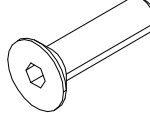
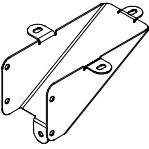

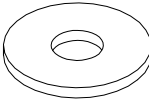
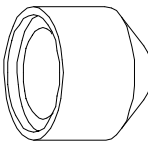
ASENNUSOHJE
MONTERINGSANSVISNING
INSTALLATION INSTRUCTION
AUFBAUANLEITUNG
NOTICE D'INSTALLATION

DATE: 2.10.2024

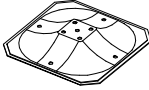
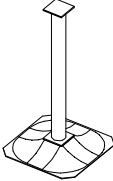
Q18501

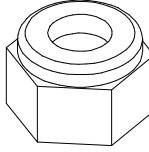
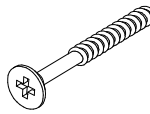
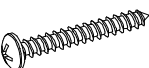

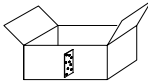
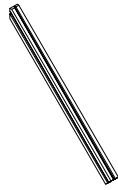
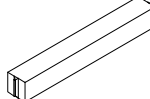
DATE: 2.10.2024

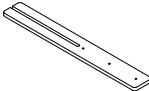
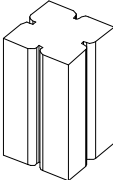
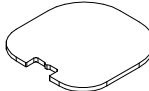
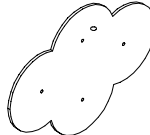
| | | | | | | | | | | | |
|--|----------|--|-----------|--|----------|--|-----------|---|----------|---|----------|
| 702286  65x65 | PCS 1 | 706453-702  15x145x600 | PCS 1 | 706481-707  83x83x10 | PCS 4 | 706512  70x120x704 | PCS 2 | 706531  FASTENER KIT | PCS 4 | 706609  | PCS 2 |
| 707420  93x93x1370 | PCS 2 | 707729  | PCS 1 | 709372-702  423x351 | PCS 1 | 709402   | PCS 1 | 900240  Ø8x70 | PCS 8 | 901487  M10x40 | PCS 8 |
| 902086  148x172x254 | PCS 1 | 903093  Ø8x90 | PCS 10 | 905051  Ø24/8.5 | PCS 8 | 905104  M10 | PCS 24 | 907770  2x35/40x1659 | PCS 4 | 909231  8x130 | PCS 4 |
| 909233  8x100 | PCS 4 | 909511  90x90x650 | PCS 4 | 909519  50x380x380 | PCS 4 | 909521   | PCS 6 | 909637  Ø20/10,5 | PCS 8 | 980107  Ø6x60 | PCS 8 |
| 980114  Ø4x20 | PCS 4 | 980123  Ø7x60 | PCS 4 | 980128  Ø7x40 | PCS 3 | A10394  | PCS 2 | P07514  | PCS 4 | P07698  L 707 | PCS 1 |
| P10201-702  Ø280 | PCS 2 | P11490-707  15x686x1660 | PCS 2 | P14556-704  10x93x702 | PCS 1 | P14992  93x93x170 | PCS 2 | P16873-702  15x385x385 | PCS 1 | P18239-707  10x497x682 | PCS 2 |
| | PCS | | PCS | | PCS | | PCS | | PCS | | PCS |

—— EN/AS Impact Area 10.2 m²
- - - - Falling Space 20.6 m²
Max Falling Height 1480 mm

