

PLEASE NOTE, THE PRODUCT
DOES NOT CONTAIN A SAND HOPPER, SIVES,
ROTATING SIVES
SAND CRANE WITH 2 HORIZONTAL BARS.

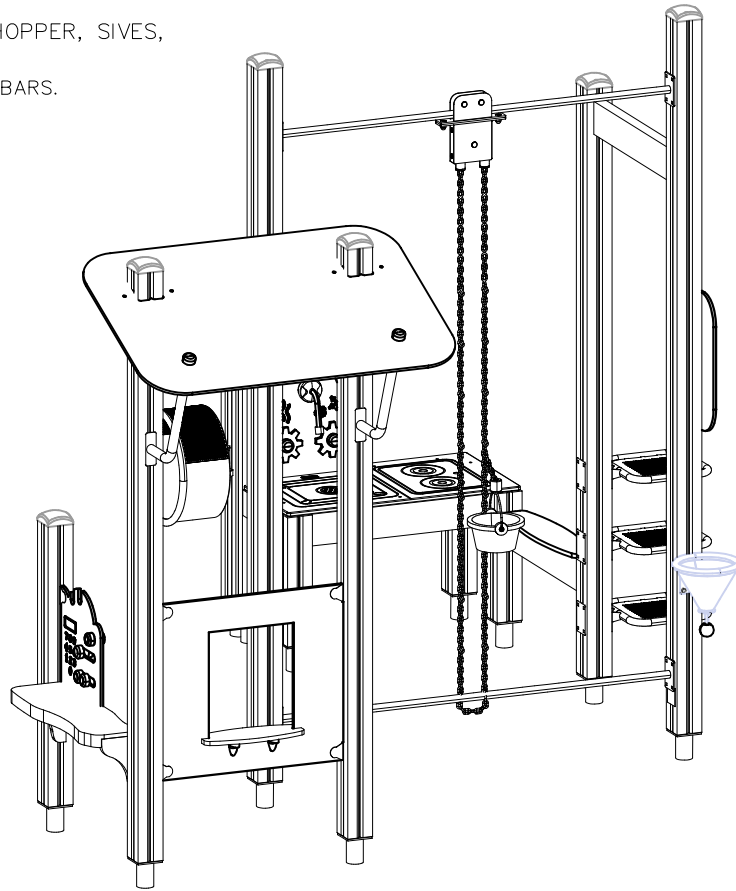

Max falling height

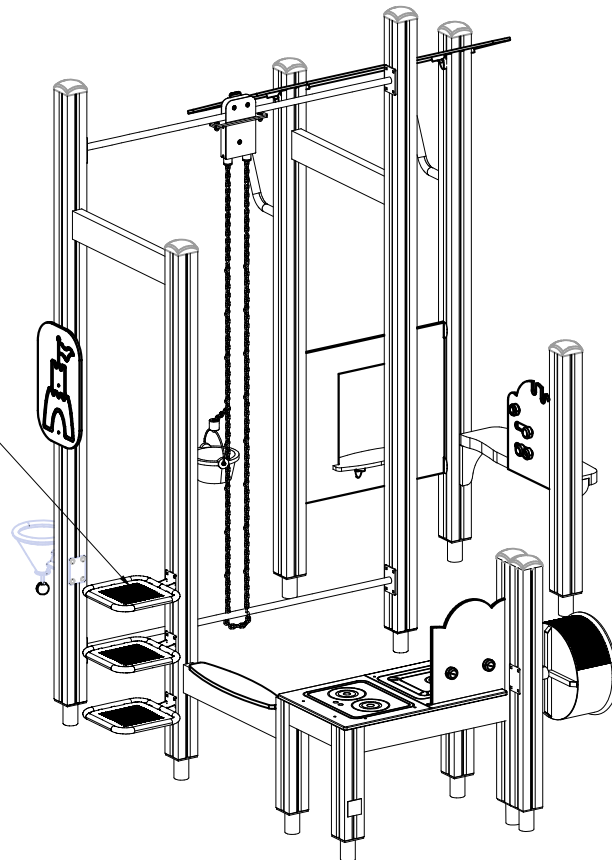



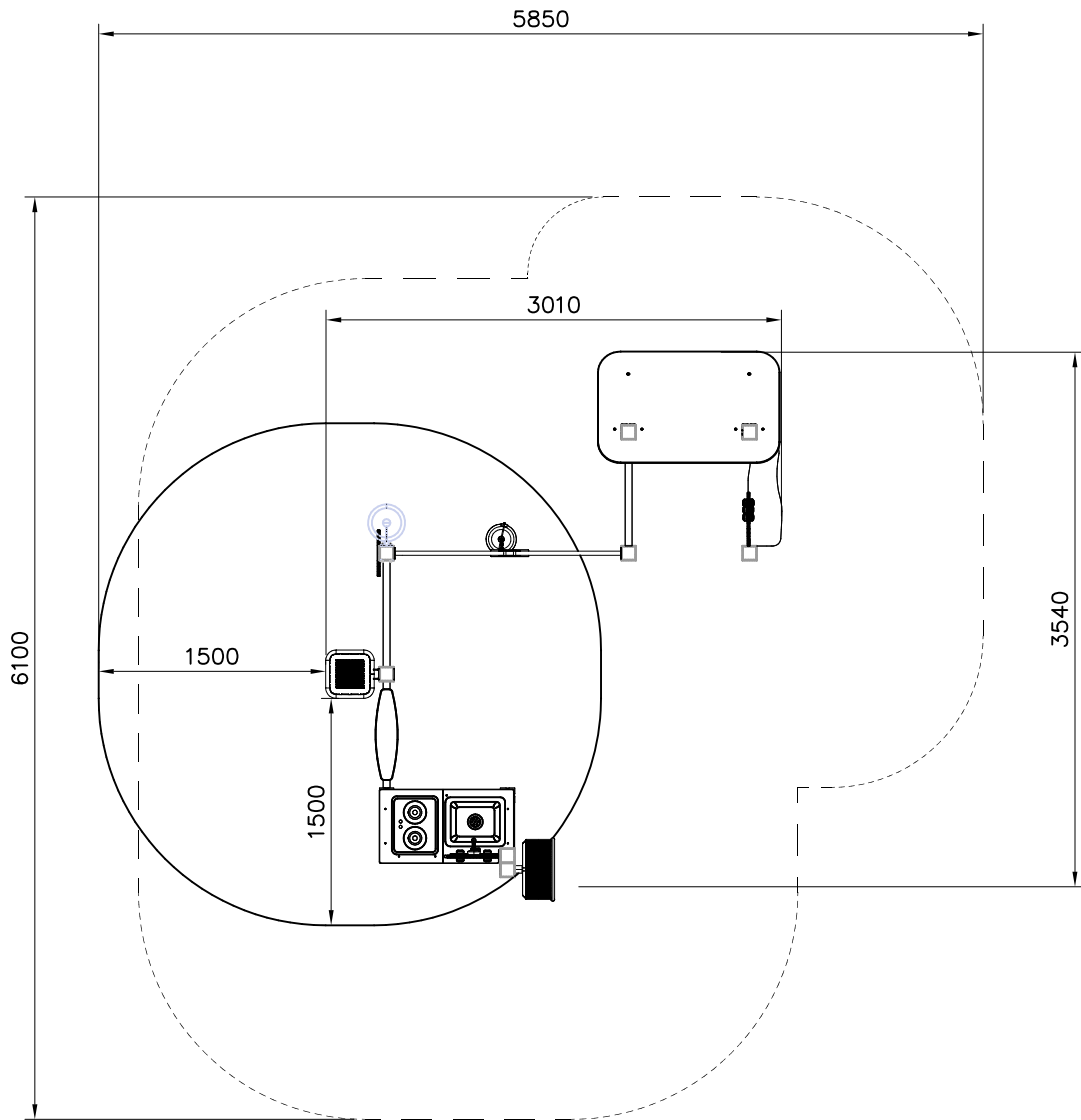
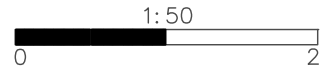

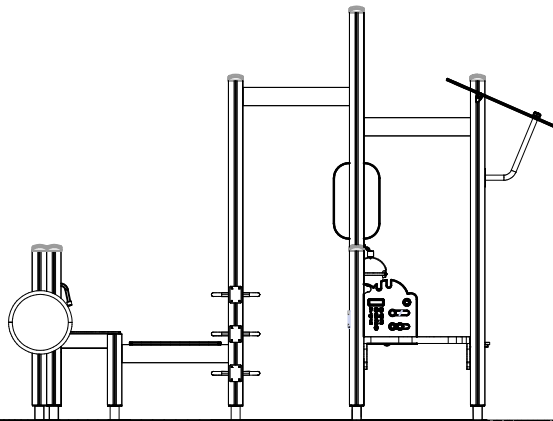
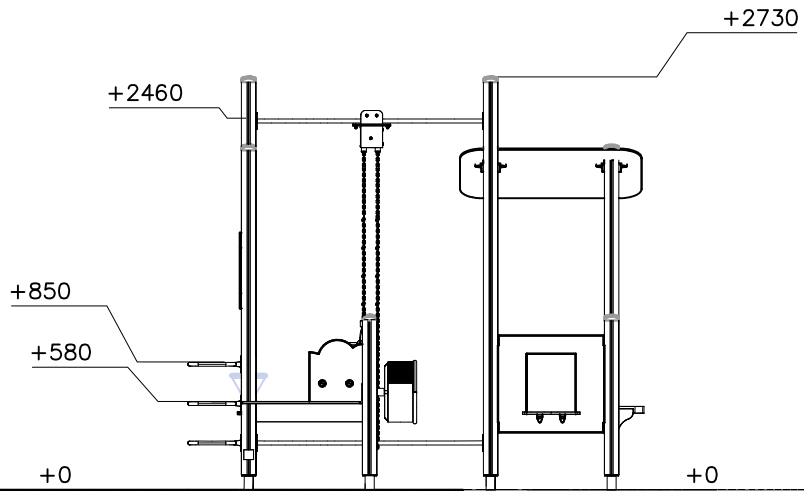



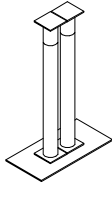

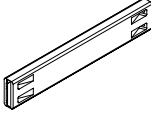
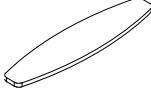

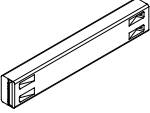

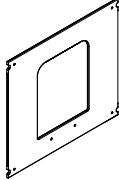
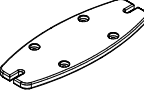
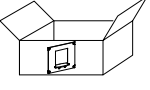
- EN/AS Impact Area 9.1 m²
- - - Falling Space 27.7 m²
Max Falling Height 850 mm

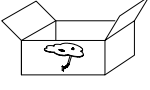
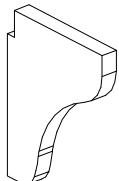

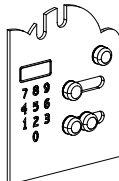
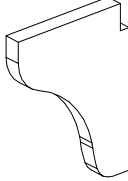
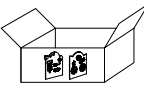
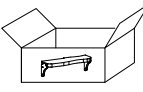
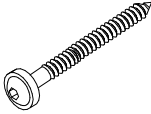
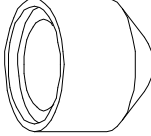
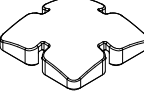
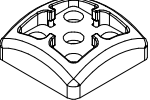
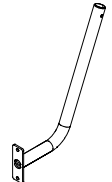

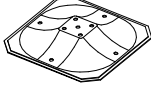
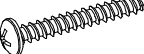
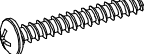
DATE: 14.12.2023

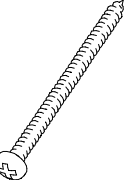
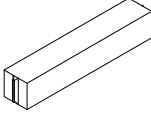
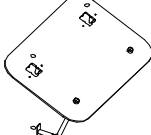
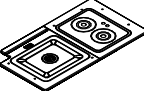
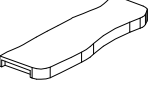
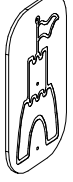
2	PCS 1	701931  65x65	PCS 1	702286  65x65	PCS 2	706439  L 704	PCS 3	706453-707  15x145x600	PCS 1	706466  93x93x1025	PCS 3
706484  93x93x2150	PCS 3	706512  70x120x704	PCS 2	706531  93x93x2600	PCS 9	706662  93x93x2600	PCS 2	706727-707  10x702x640	PCS 1	706744  15x145x380	PCS 1
706885 	PCS 1	707331  93x93x470	PCS 3	707665 	PCS 2	709350-705  20x154x200	PCS 1	709351-707  423x351	PCS 1	709372-707  423x351	PCS 1
709400-705  20x154x200	PCS 1	709402  65x65	PCS 2	709476  65x65	PCS 1	903093  Ø8x90	PCS 24	905104  M10	PCS 8	905138  GRAY	PCS 8
905196  GRAY	PCS 8	908207-216  336x392x40	PCS 2	909511  90x90x650	PCS 9	909519  50x380x380	PCS 9	980105  Ø5x120	PCS 2	980114  Ø4x20	PCS 8
980123  Ø7x60	PCS 4	980128  Ø7x40	PCS 10	980131  Ø6x60	PCS 32	P10884  L 307	PCS 2	P15807  800x1200	PCS 1	P16227-705  10x93x702	PCS 1
P17290  45x224x702	PCS 1	P17291  10x300x500	PCS 1		PCS		PCS		PCS		PCS