

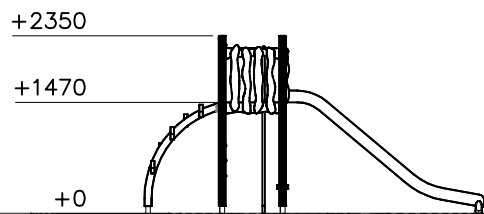

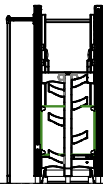

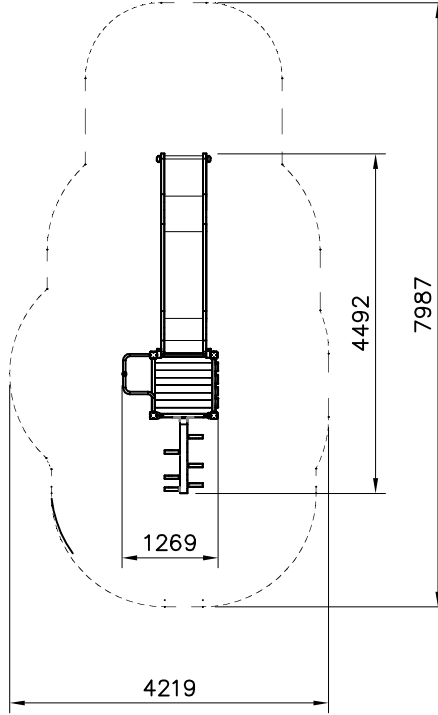





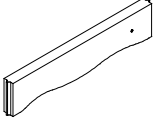
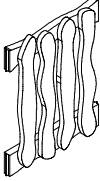
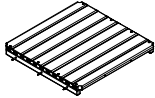
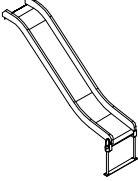
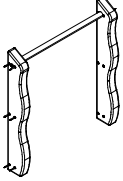

—— EN/AS Impact Area 25.4 m²
- - - - Falling Space 25.7 m²
Max Falling Height 1470 mm

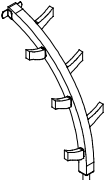

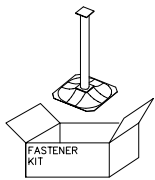
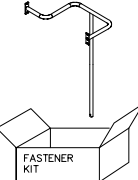
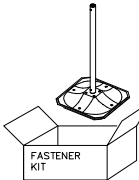
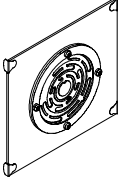
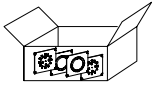
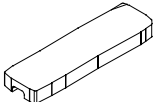
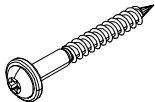
DATE: 15.9.2023

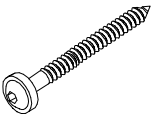
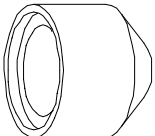
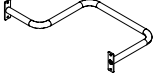
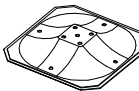
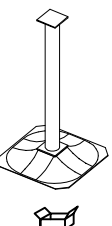
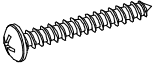
702286	PCS 1	705211	PCS 4	705230	PCS 1	705258	PCS 1	705308	PCS 1	705310	PCS 1
											
65x65		L=724									
705368	PCS 1	705511	PCS 2	706179	PCS 4	706531	PCS 1	706541	PCS 1	706542	PCS 1
											
				L=2246							
706766-707	PCS 1	706778	PCS 1	708752	PCS 1	900240	PCS 2	901902	PCS 2	901916	PCS 1
											
				45x145x500		Ø8x70				L 650	
903093	PCS 16	905104	PCS 16	907695-216	PCS 1	907698-216	PCS 1	909511	PCS 1	909519	PCS 2
											
Ø8x90		M10				L 2054					
909521	PCS 4	980114	PCS 4		PCS		PCS		PCS		PCS
											
		Ø4x20									
	PCS		PCS		PCS		PCS		PCS		PCS
	PCS		PCS		PCS		PCS		PCS		PCS