

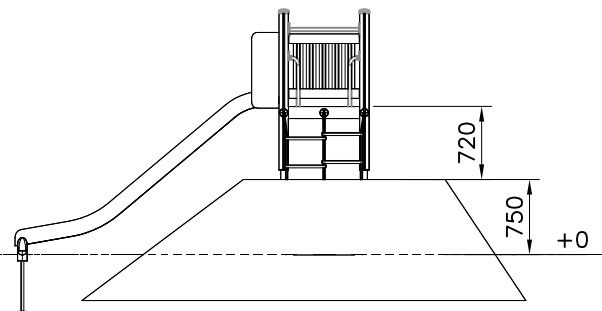

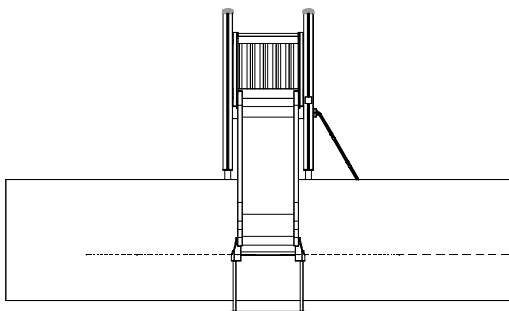

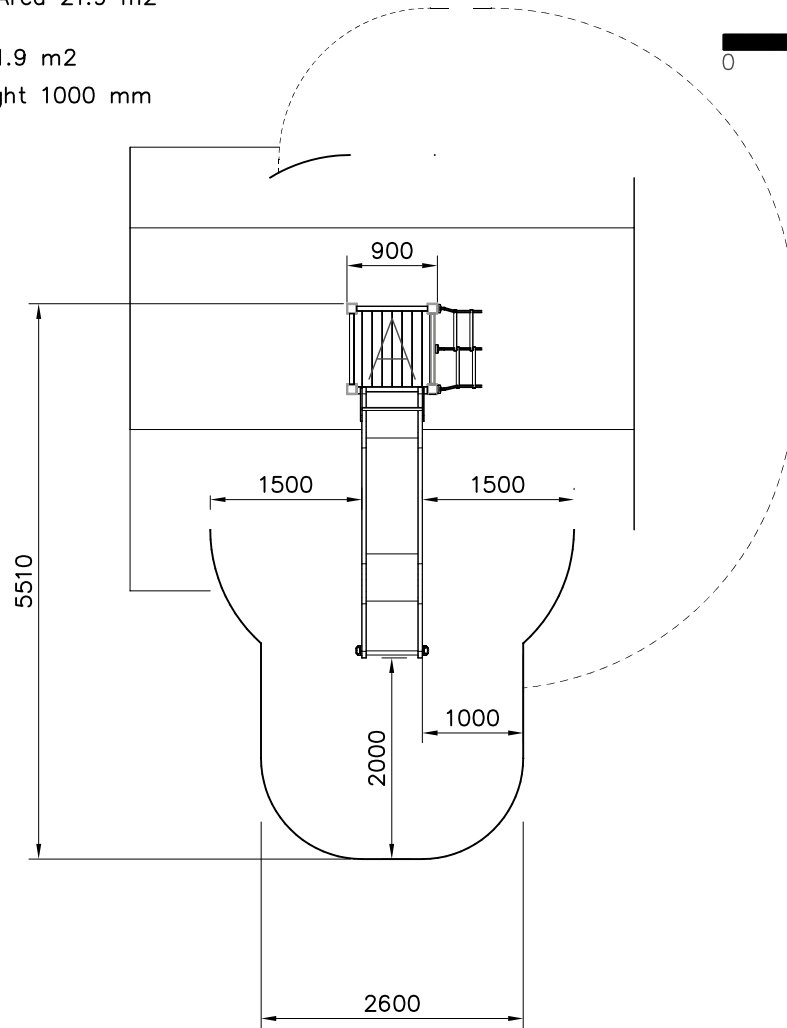

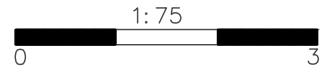



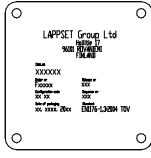

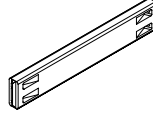
- EN/AS Impact Area 21.9 m<sup>2</sup>
- - - Falling Space 21.9 m<sup>2</sup>  
Max Falling Height 1000 mm

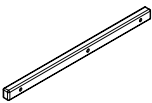
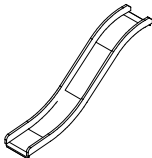

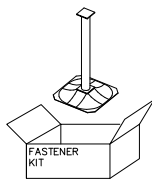
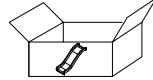
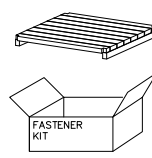
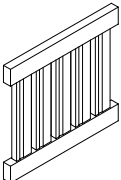
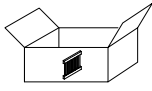
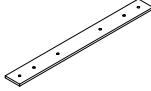
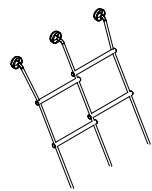
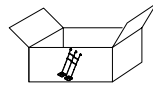
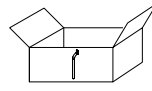
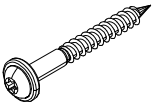
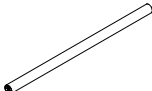
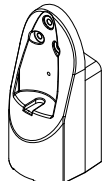
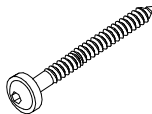
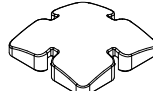
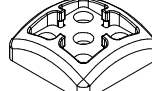
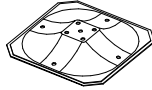
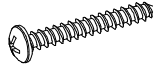
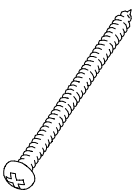
DATE: 29.11.2022

008986	PCS	702286	PCS	706371-704	PCS	706439	PCS	706441	PCS	706443	PCS
	1		1		2		4		4		2
750x750		65x65		15x345x750		L 704		93x93x1550		32x45x702	
706450-604	PCS	706505	PCS	706531	PCS	706533	PCS	706535	PCS	706746	PCS
	1		2		4		1		1		2
600x381x2685		35x70x730								45x640x701	
706748	PCS	707133	PCS	707390-305	PCS	707546	PCS	707732	PCS	900240	PCS
	2		1		1		1		2		4
		10x80x745								Ø8x70	
901868	PCS	901879	PCS	903093	PCS	905138	PCS	905196	PCS	907694-216	PCS
	3		2		16		4		4		1
Ø34x598				Ø8x90		GRAY		GRAY		L 704	
907701-216	PCS	909511	PCS	909519	PCS	980114	PCS	980131	PCS		PCS
	2		4		6		4		16		
		90x90x650		50x380x380		Ø4x20		Ø6x60			
	PCS		PCS		PCS		PCS		PCS		PCS
	PCS		PCS		PCS		PCS		PCS		PCS