

Max Falling Height

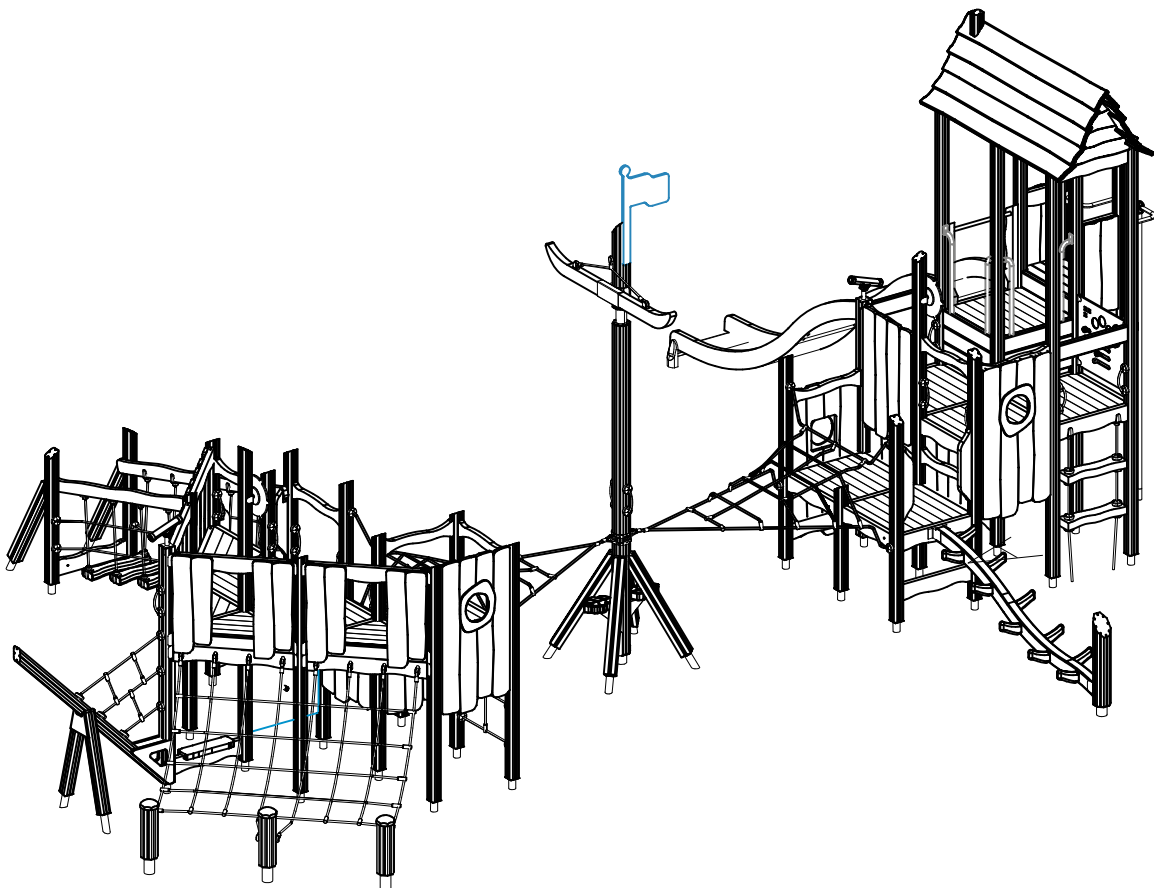

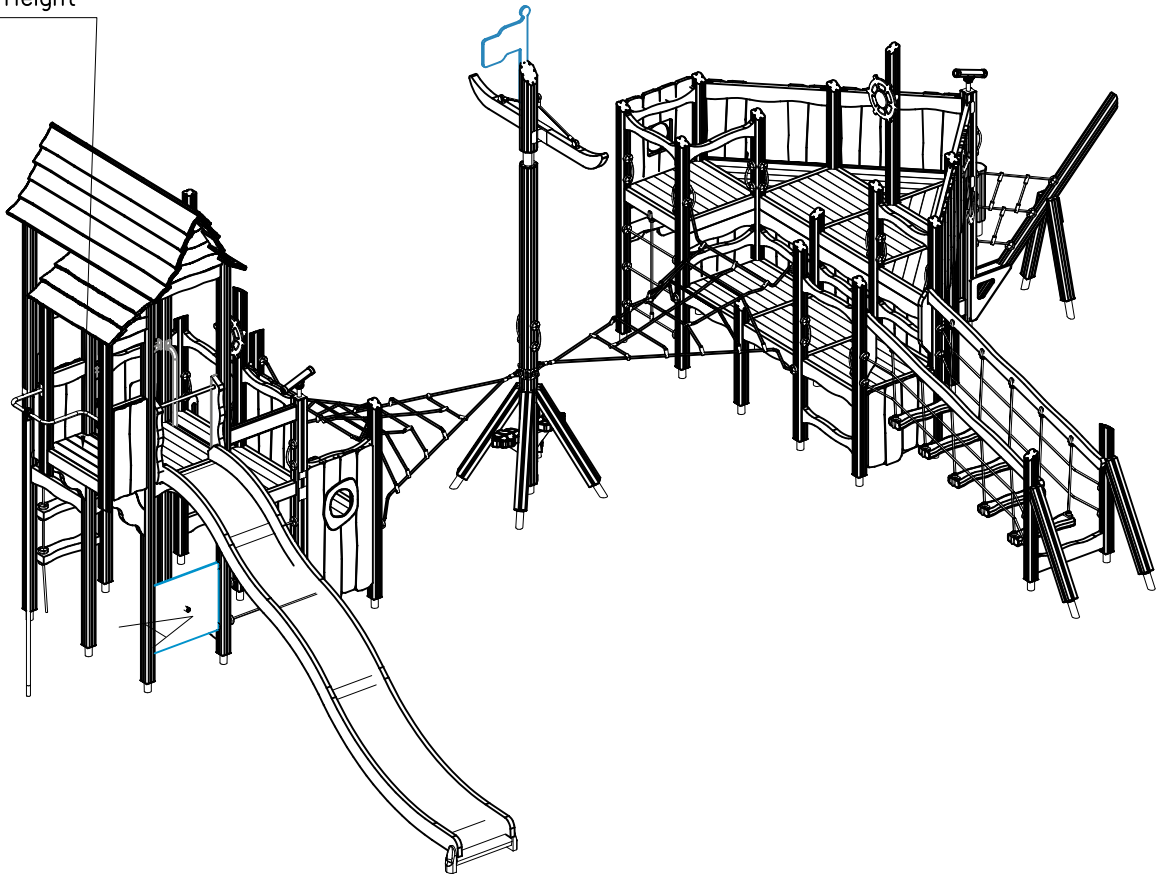

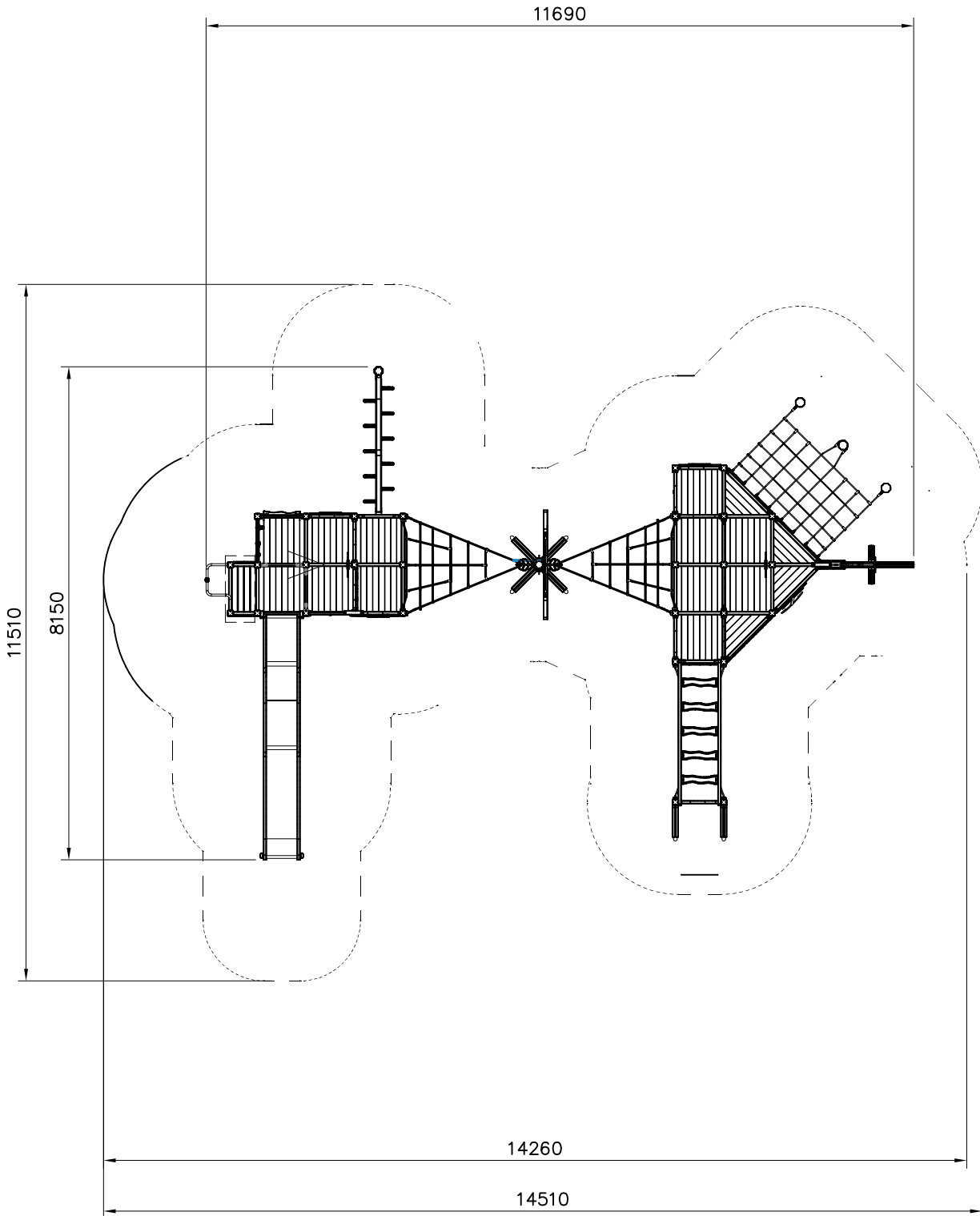

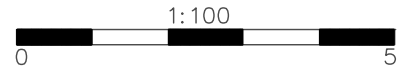
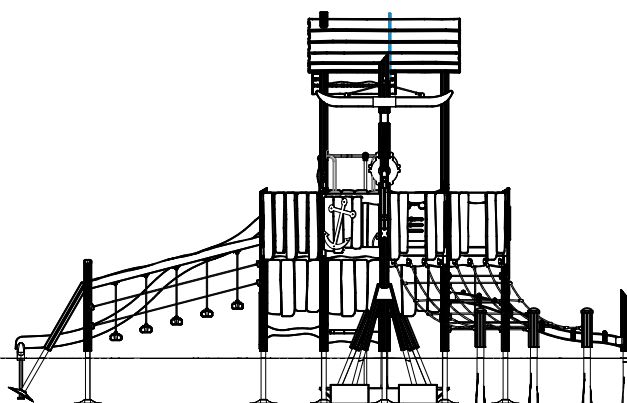
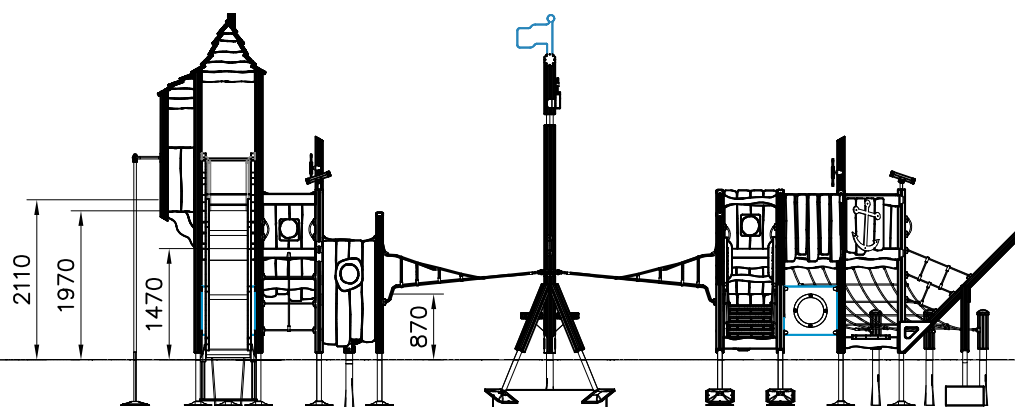



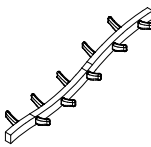
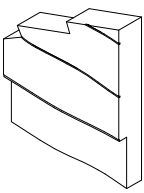
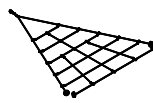
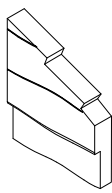
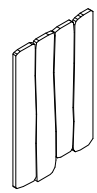
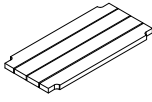
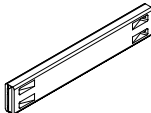
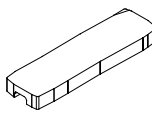
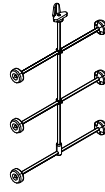

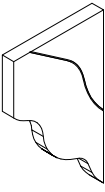
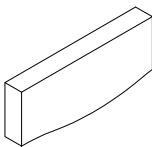
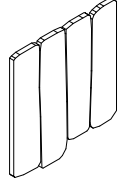
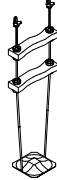

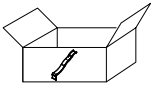
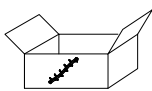

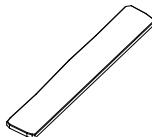
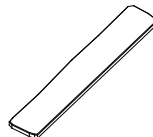

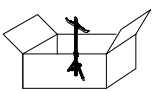
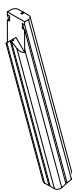
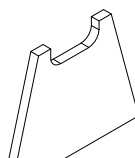
- EN/AS Impact Area 91.5 m²
- - - - Falling Space 97.7 m²
Max Falling Height 1470 mm

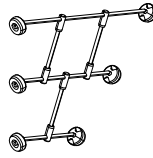
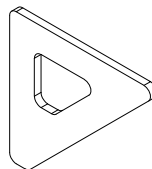
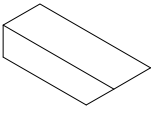
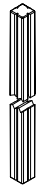
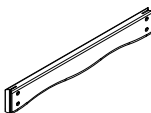
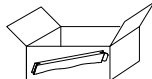
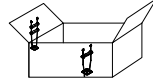
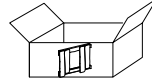
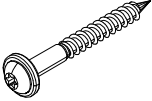
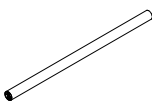

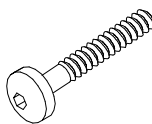







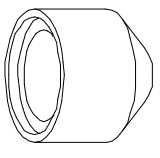
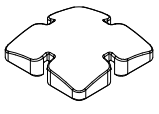
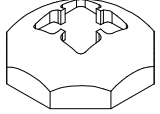
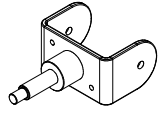

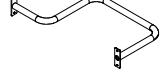

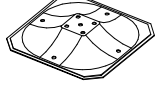
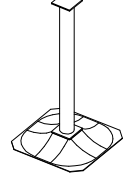
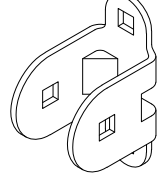
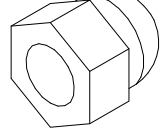
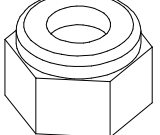
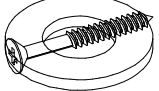
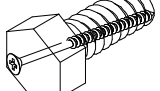
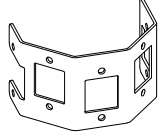
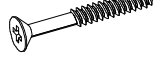
DATE: 22.9.2022

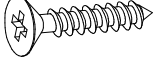
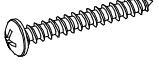
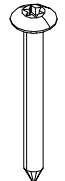
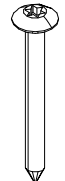
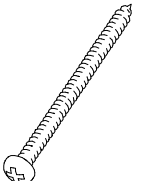
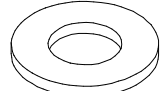
708576  140x140x800	PCS 1	708577  L=2260	PCS 1	708645 	PCS 1	708661 	PCS 2	708670 	PCS 1	708691  28x700x1100	PCS 1
708709  32x400x840	PCS 1	708746  L 724	PCS 10	708752  45x145x500	PCS 2	708879  705x940	PCS 2	708884  45x374x591	PCS 1	708885  45x374x591	PCS 1
708906  45x145x372	PCS 2	708917  28x700x740	PCS 8	708923 	PCS 1	709037  28x350x850	PCS 2	709052  93x93x1720	PCS 2	709683 	PCS 1
709869 	PCS 1	709889  L=3750	PCS 6	709891  28x700x885	PCS 3	709892  28x700x795	PCS 2	710054  93x93x1000	PCS 4	710064 	PCS 1
710082  93x93x891	PCS 2	710083  15x200x250	PCS 1	710084  93x93x2183	PCS 1	710085  584x950	PCS 1	710086  20x400x428	PCS 2	710087  70x93x280	PCS 1
710106  93x93x2150	PCS 2	710171  45x145x1031	PCS 6	710172 	PCS 6	710318 	PCS 1	710349 	PCS 2	900240  Ø8x70	PCS 39
901868  Ø30x598	PCS 2	901879 	PCS 2	901899  M8x45	PCS 2	901916  L 650	PCS 1	903093  Ø8x90	PCS 383	903112  L 750	PCS 4

DATE: 22.9.2022

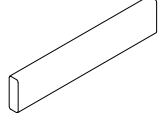
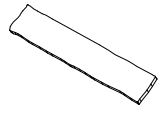
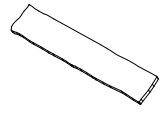
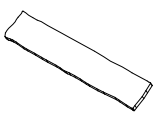
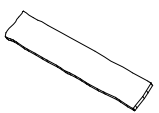
 905104 M10	PCS 48	 905139 69x69x20	PCS 3	 905197 147x147x56.5	PCS 3	 905879	PCS 2	 907688-216	PCS 4	 907695-216	PCS 1
 907817-216 L 2554	PCS 1	 909511 90x90x650	PCS 26	 909519 50x380x380	PCS 27	 909521	PCS 8	 909561	PCS 4	 909633 M8	PCS 2
 909637 M10	PCS 8	 909638 Ø20/10,5	PCS 16	 909639 M10x25	PCS 8	 910566	PCS 2	 980100 Ø5x60	PCS 192	 980101 Ø4,5x70	PCS 4
 980110 Ø4x35	PCS 12	 980114 Ø4x20	PCS 12	 980123 7x60	PCS 20	 980128 Ø7x40	PCS 8	 980131 Ø6x60	PCS 12	 980151 Ø16/8.4	PCS 4
 P07524	PCS 4	 P07526 L=1546	PCS 1	 P07664 L 1200	PCS 2	 P13093 45x145x724	PCS 9	 P13450 28x200x1100	PCS 3	 P13451 28x200x2000	PCS 8
 P13455 28x200x2000	PCS 1	 P13456 28x200x2000	PCS 1		PCS		PCS		PCS		PCS
	PCS		PCS		PCS		PCS		PCS		PCS

