

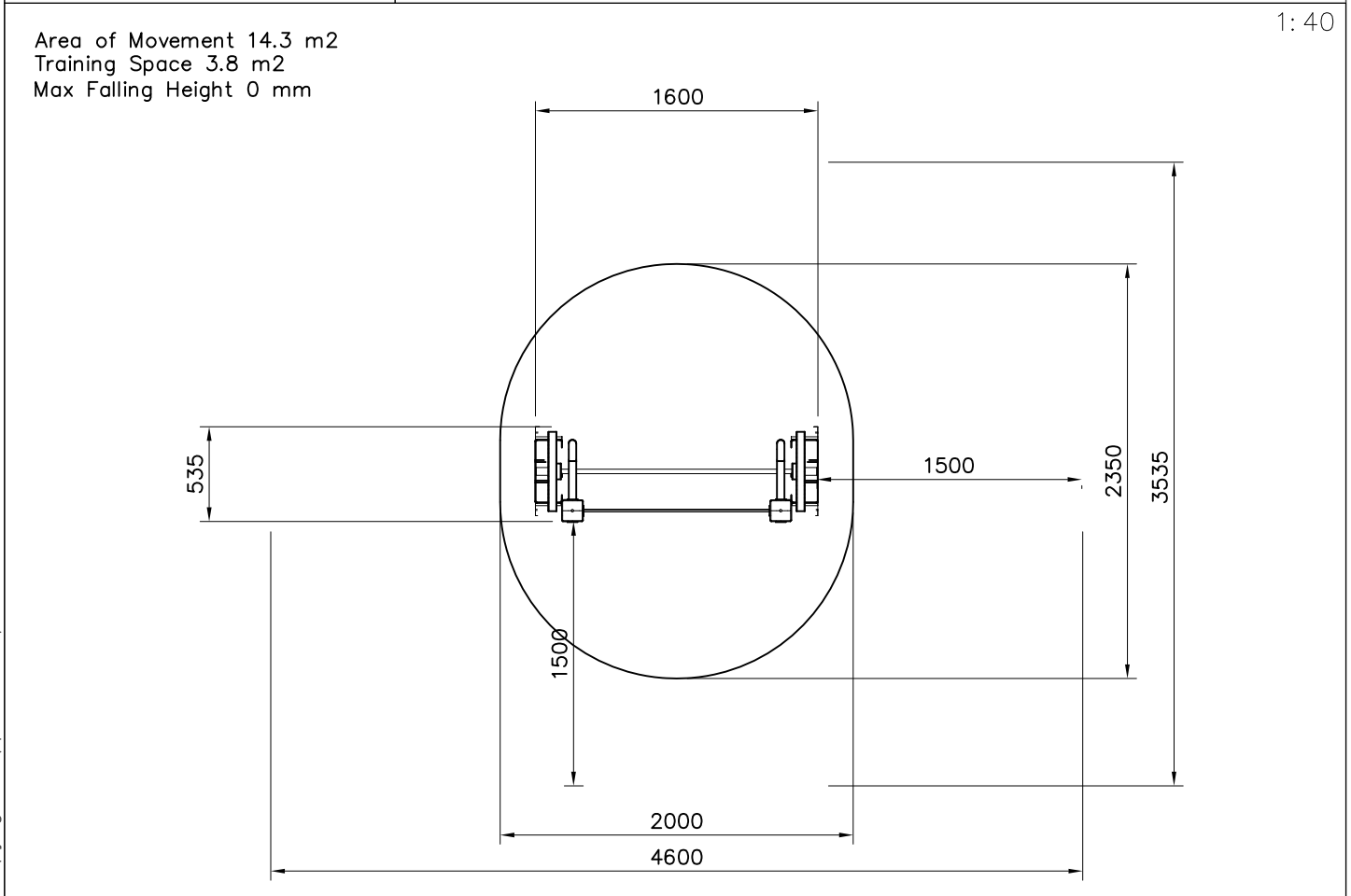

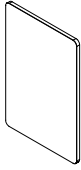

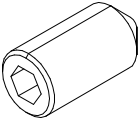





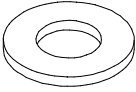

Area of Movement 14.3 m²
Training Space 3.8 m²
Max Falling Height 0 mm

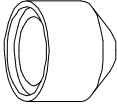
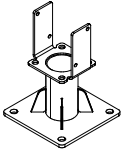

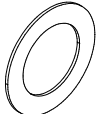
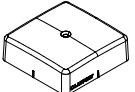

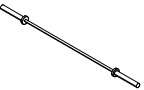
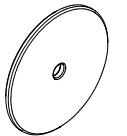
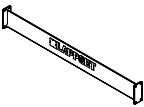
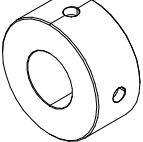
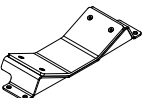
| | | | | | | | |
|------------------------------------------------------------------------------------------------|-----|---------------------------------------------------------------------------------------------------|-----|-----------------------------------------------------------------------------------------------------|-----|---------------------------------------------------------------------------------------------------|-----|
| ① 706021 | PCS | ② 909500 | PCS | ⑬ 980123 | PCS | ⑭ 909256 | PCS |
|  | 1 |  M10x20 | 4 |  Ø7x60 | 24 |  Ø16/8.4 | 24 |
| ③ 980114 | PCS | ④ 904450 | PCS | ⑮ 906642 | PCS | ⑯ 980129 | PCS |
|  Ø4x20 | 4 |  M16x170 | 8 |  Ø50/45x20 | 4 |  Ø5x35 | 20 |
| ⑤ 905104 | PCS | ⑥ 905780 | PCS | ⑰ 705322 | PCS | ⑱ 905817 | PCS |
|  M10 | 8 |  120x120x150 | 2 |  120x120x2500 | 2 |  2626X386X60 | 2 |
| ⑦ 906770 | PCS | ⑧ 905830 | PCS | ⑳ 906577 | PCS | ㉑ 907560 | PCS |
|  Ø74/48x2 | 4 |  123x123x40 | 2 |  30x30x3x2250 | 2 |  Ø90/46-33 | 2 |
| ⑨ 906637 | PCS | ⑩ 906601 | PCS | | | | |
|  L=1590 | 1 |  Ø450 5kg | 2 | | | | |
| ⑪ 906605 | PCS | ⑫ 908976 | PCS | | | | |
|  L=1060 | 1 |  Ø98/45x44 | 2 | | | | |
| ⑬ 705542 | PCS | ⑰ 980104 | PCS | | | | |
|  L=1060 | 2 |  Ø5x90 | 2 | | | | |
| ⑮ 909628 | PCS | | | | | | |
|  M10x100 | 16 | | | | | | |

STEELNET Ø6 #150
(1400x2100)
Concrete
1500X2200X200 K30

NOTE!
HOX!

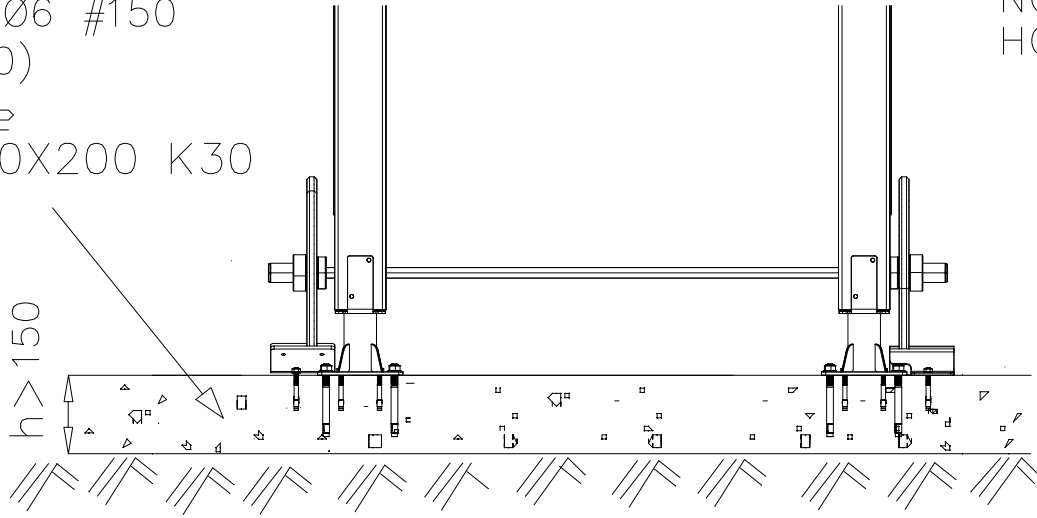

Esireikä / Pre-drill hole.

