

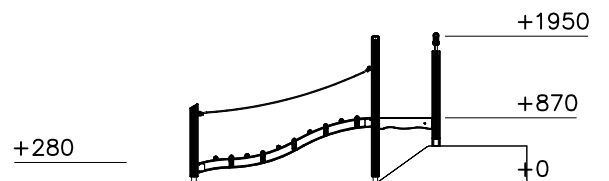

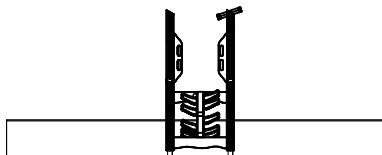

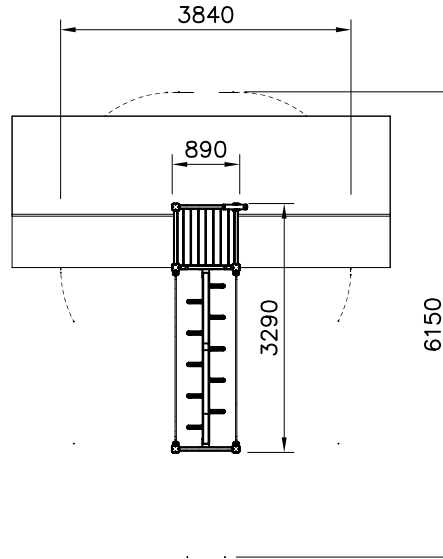

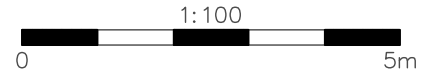

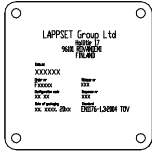
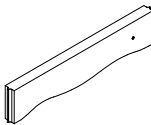
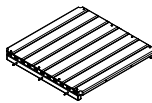
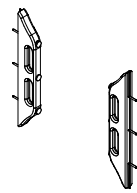

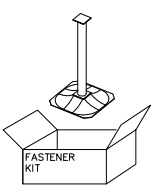
- EN/AS Impact Area 20.5 m<sup>2</sup>
- - - - Falling Space 20.5 m<sup>2</sup>  
Max Falling Height 870 mm

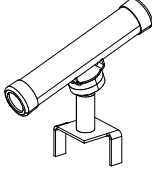
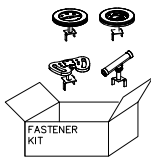
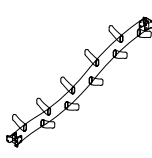
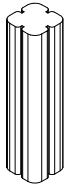

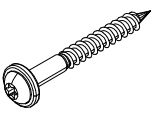
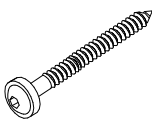
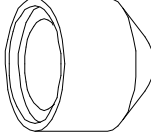
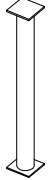
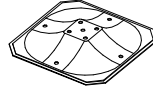
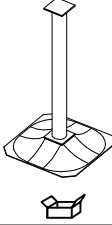
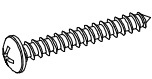
DATE: 5.1.2021

702286	PCS 1	705211	PCS 5	705258	PCS 1	705506	PCS 1	706193	PCS 2	706531	PCS 3
											
65x65		L=724						L=946			
707304	PCS 1	707585	PCS 1	709111	PCS 1	709123	PCS 1	709693	PCS 1	900240	PCS 8
											
				L=2260		93x93x370		L=1150		8x70	
903093	PCS 20	905104	PCS 12	909511	PCS 3	909519	PCS 3	909521	PCS 3	980114	PCS 4
											
Ø8x90		M10								Ø4x20	
P07524	PCS 2	P13351	PCS 2		PCS		PCS		PCS		PCS
											
		L 2400									
	PCS		PCS		PCS		PCS		PCS		PCS
	PCS		PCS		PCS		PCS		PCS		PCS