

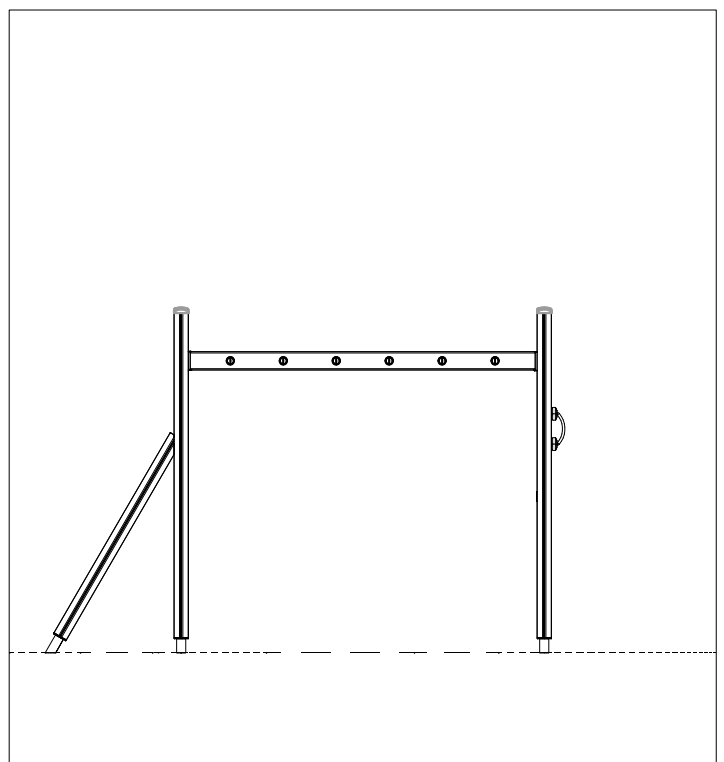

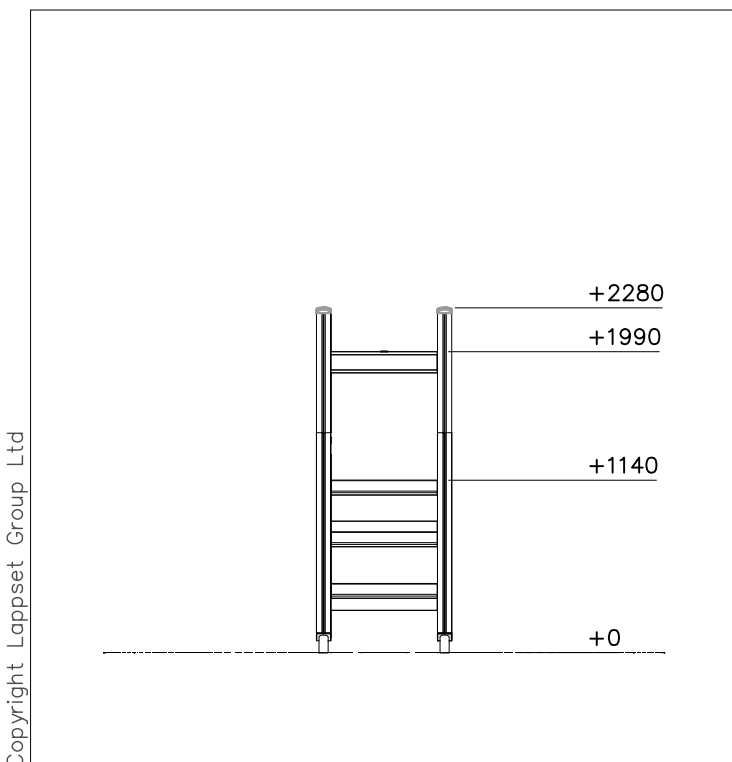

- EN/AS Impact Area 17.1 m<sup>2</sup>
- - - - Falling Space 18.1 m<sup>2</sup>
- Max Falling Height 1140 mm

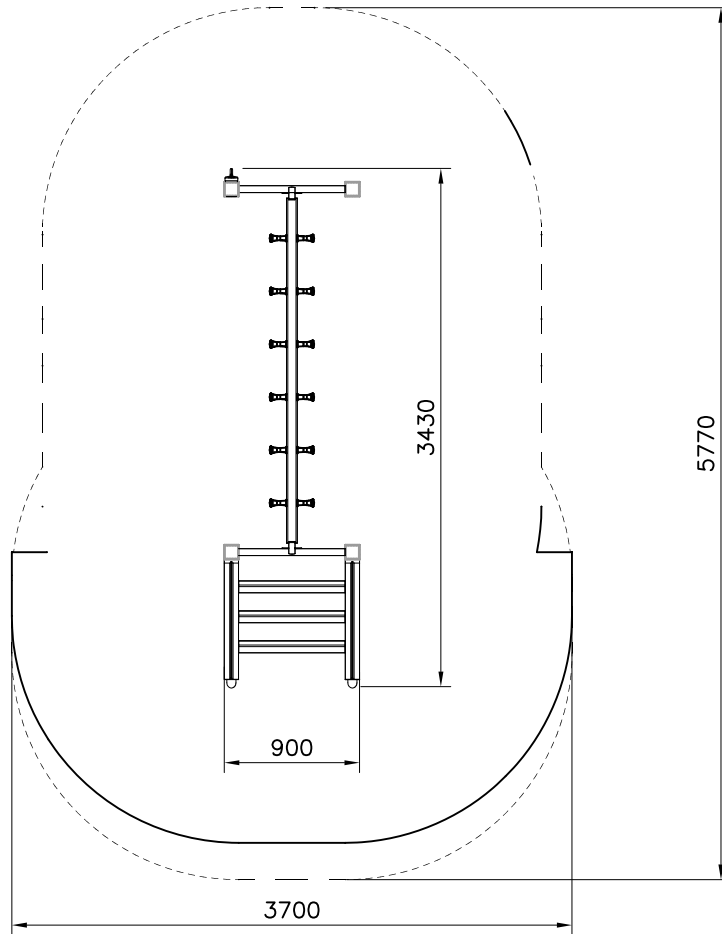
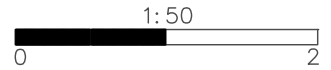
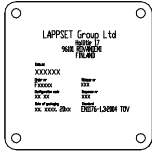
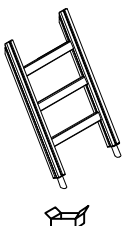

DATE: 17.12.2020

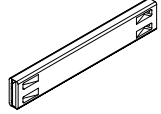
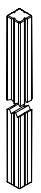
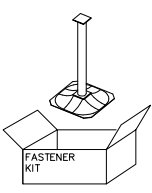
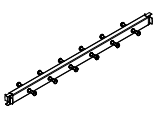
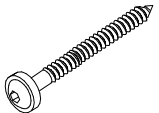
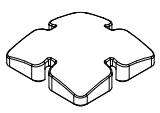
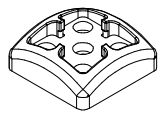
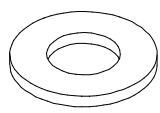
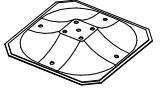
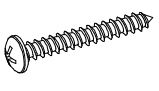
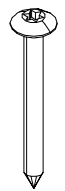
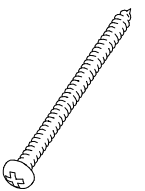
<p>702286</p>  <p>65x65</p>	<p>PCS</p> <p>1</p>	<p>703130</p> 	<p>PCS</p> <p>1</p>	<p>705511</p> 	<p>PCS</p> <p>1</p>	<p>706439</p>  <p>L 704</p>	<p>PCS</p> <p>6</p>	<p>706484</p>  <p>93x93x2150</p>	<p>PCS</p> <p>4</p>	<p>706531</p>  <p>FASTENER KIT</p>	<p>PCS</p> <p>4</p>
<p>707290</p>  <p>127x300x2355</p>	<p>PCS</p> <p>1</p>	<p>903093</p>  <p>Ø8x90</p>	<p>PCS</p> <p>24</p>	<p>905138</p>  <p>GRAY</p>	<p>PCS</p> <p>4</p>	<p>905196</p>  <p>GRAY</p>	<p>PCS</p> <p>4</p>	<p>909256</p>  <p>Ø16/8.4</p>	<p>PCS</p> <p>12</p>	<p>909511</p>  <p>90x90x650</p>	<p>PCS</p> <p>4</p>
<p>909519</p>  <p>50x380x380</p>	<p>PCS</p> <p>4</p>	<p>980114</p>  <p>Ø4x20</p>	<p>PCS</p> <p>4</p>	<p>980128</p>  <p>Ø7x40</p>	<p>PCS</p> <p>12</p>	<p>980131</p>  <p>Ø6x60</p>	<p>PCS</p> <p>16</p>		<p>PCS</p>		<p>PCS</p>
	<p>PCS</p>		<p>PCS</p>		<p>PCS</p>		<p>PCS</p>		<p>PCS</p>		<p>PCS</p>
	<p>PCS</p>		<p>PCS</p>		<p>PCS</p>		<p>PCS</p>		<p>PCS</p>		<p>PCS</p>
	<p>PCS</p>		<p>PCS</p>		<p>PCS</p>		<p>PCS</p>		<p>PCS</p>		<p>PCS</p>