

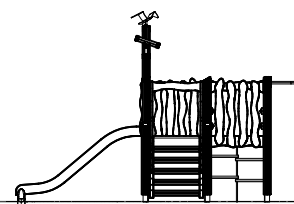

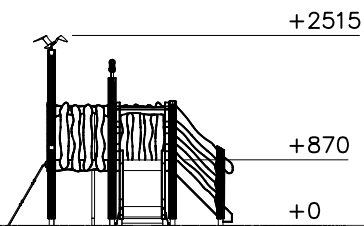

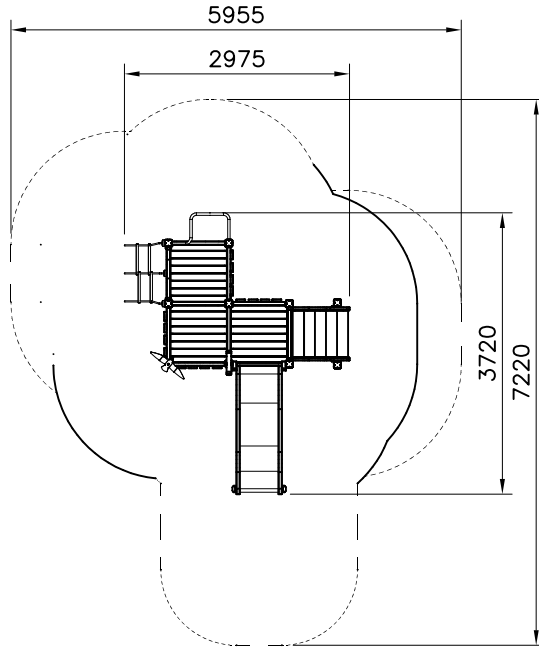

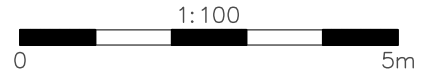

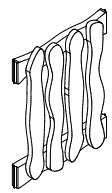
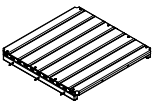
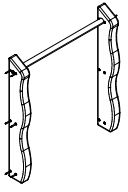

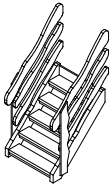
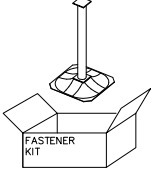

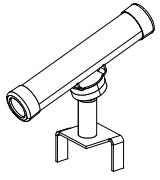
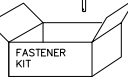
- EN/AS Impact Area 25.6 m<sup>2</sup>
- - - - Falling Space 28.9 m<sup>2</sup>  
 Max Falling Height 1000 mm

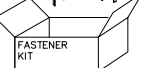
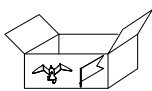
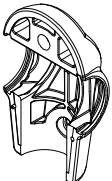

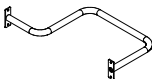
DATE: 27.10.2020

702286	PCS	702339	PCS	705211	PCS	705214	PCS	705230	PCS	705258	PCS
	1		1		6		1		4		3
65x65		118x78		L=724		45x145x724					
705310	PCS	705511	PCS	706185	PCS	706193	PCS	706234	PCS	706531	PCS
	1		2		1		2		1		3
						L=946					
706541	PCS	706542	PCS	707304	PCS	707390-303	PCS	707546	PCS	707585	PCS
	1		1		1		1		1		1
											
707693	PCS	709124	PCS	901902	PCS	901916	PCS	903093	PCS	905104	PCS
	1		1		2		1		26		28
		93x93x1850		30.7x60.9x100		L 650		Ø8x90		M10	
907695-216	PCS	907829-216	PCS	908357-206	PCS	909511	PCS	909519	PCS	909521	PCS
	1		1		1		3		6		7
		L 1454				90x90x650		50x380x380			
980114	PCS	P07526	PCS	P13242	PCS		PCS		PCS		PCS
	8		6		1						
Ø4x20		L=1546		L=2220							
	PCS		PCS		PCS		PCS		PCS		PCS