

LAPPSET®

FINNO





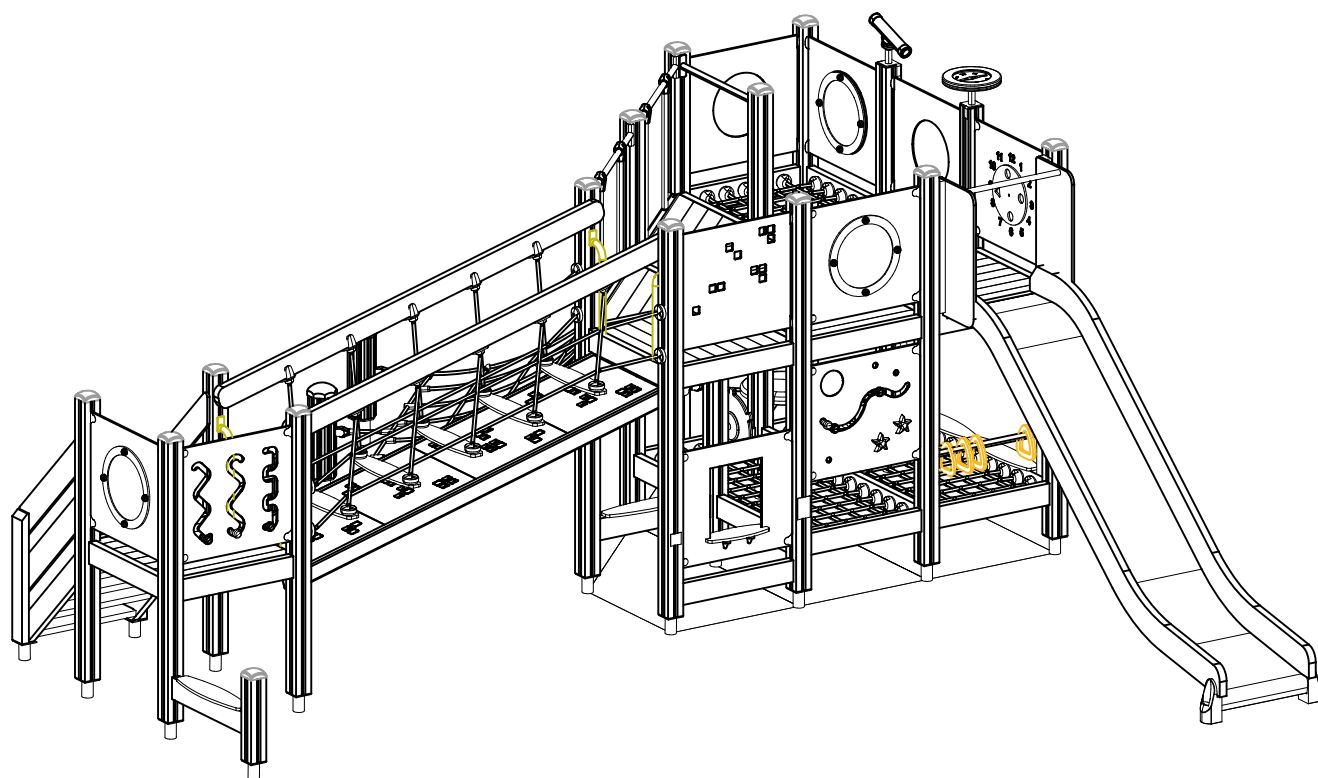

ASENNUSOHJE
MONTERINGSANSVISNING
INSTALLATION INSTRUCTION
AUFBAUANLEITUNG
NOTICE D'INSTALLATION

DATE: 31.7.2023

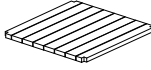
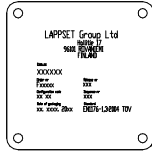
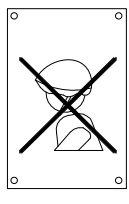
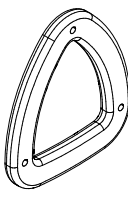
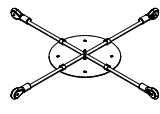
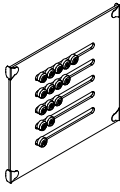
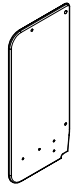
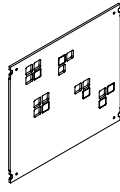
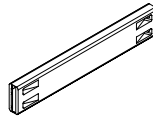

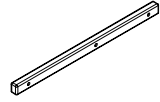
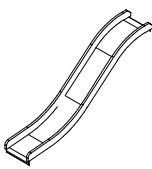
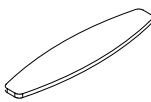

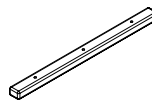
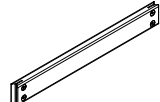
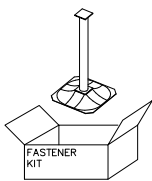
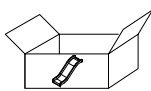
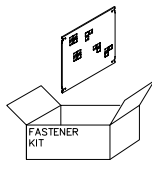
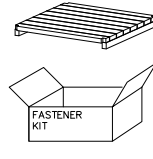
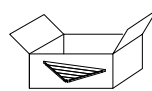
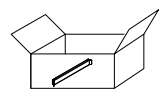
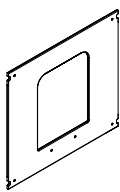
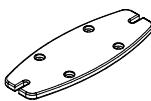
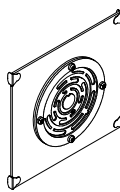
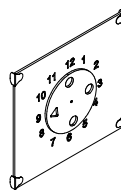
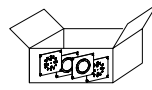
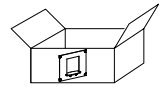
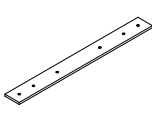
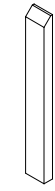
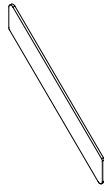
Q14662-1

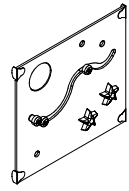
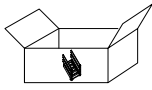
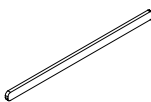
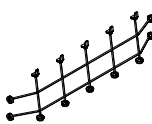
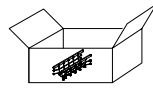
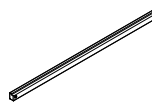
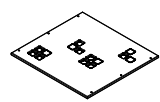

DATE: 31.7.2023

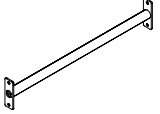
008985  32x714x714	PCS 2	008986  750x750	PCS 2	702286  65x65	PCS 1	702339  118x78	PCS 1	705369-702  L 926	PCS 4	706059-305  L 926	PCS 1
706308-702  10x640x702	PCS 1	706371-702  15x345x750	PCS 2	706436-702  10x640x702	PCS 1	706439-602  L 704	PCS 25	706441-602  93x93x1550	PCS 4	706443  32x45x702	PCS 8
706450-602  600x381x2685	PCS 1	706453  15x145x600	PCS 9	706484-602  93x93x2150	PCS 10	706505  35x70x730	PCS 2	706508  32x45x650	PCS 6	706510-602  45x120x1030	PCS 2
706531  FASTENER KIT	PCS 18	706533  FASTENER KIT	PCS 1	706534  FASTENER KIT	PCS 1	706535  FASTENER KIT	PCS 2	706537  FASTENER KIT	PCS 2	706538  FASTENER KIT	PCS 4
706727-702  10x702x640	PCS 1	706744  15x145x380	PCS 1	706766-702  15x145x1153	PCS 1	706772-702  93x93x900	PCS 1	706778  +870	PCS 2	706885  10x640x702	PCS 1
707133  10x80x745	PCS 1	707145-602  43x93x717	PCS 2	707146-702  15x145x1153	PCS 4	707154-602  93x93x900	PCS 1	707191-602  +870	PCS 1	707209-702  10x640x702	PCS 1
707224  FASTENER KIT	PCS 1	707255-602  45x120x2480	PCS 2	707260-305  2375x600	PCS 2	707268  FASTENER KIT	PCS 1	707271-602  70x95x2480	PCS 2	707272-702  15x630x590	PCS 4

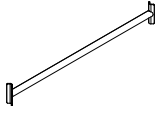
707284	PCS 1	707303-701	PCS 1	707304	PCS 1	707320-702	PCS 1	707331-602	PCS 1	707333	PCS 1
								93x93x470			
707373	PCS 1	707374-602	PCS 4	707386-702	PCS 1	707420-602	PCS 1	707436	PCS 2	707437	PCS 2
		L 1504		10x640x702		93x93x1370		750x770		32x45x1502	
707440	PCS 2	707441	PCS 2	707446	PCS 1	707450	PCS 2	707453-702	PCS 4	707454	PCS 4
		750x770						10x640x702			
707585	PCS 2	707588	PCS 1	707589	PCS 2	707590-305	PCS 1	707593-602	PCS 2	707595-305	PCS 2
						755x755		45x120x1030		755x1555	
707597-602	PCS 3	707600-305	PCS 1	707615	PCS 1	707625	PCS 2	707732	PCS 6	900240	PCS 16
140x140x450										Ø8x70	
900733	PCS 1	901868	PCS 3	901879	PCS 2	903093	PCS 116	903112	PCS 3	905104	PCS 24
Ø450x83		Ø34x598				Ø8x90		L 750		M10	
905138	PCS 14	905139	PCS 3	905196	PCS 14	905197	PCS 3	905879	PCS 1	907688-216	PCS 2
GRAY		69x69x20		GRAY		147x147x56.5					

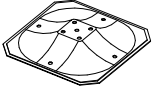
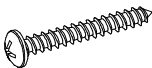
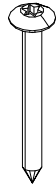
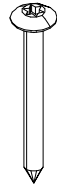
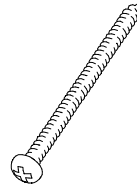
907694-217	PCS 4		907701-217	PCS 4		907920-216	PCS 2		908044-216	PCS 4		909511	PCS 18		909519	PCS 18	
L 704						120x40x1029			Ø33,7x679			90x90x650			50x380x380		
980114	PCS 8		980123	PCS 16		980128	PCS 4		980131	PCS 68							
Ø4x20			Ø7x60			Ø7x40			Ø6x60								
	PCS			PCS			PCS			PCS			PCS				PCS
	PCS			PCS			PCS			PCS			PCS				PCS
	PCS			PCS			PCS			PCS			PCS				PCS
	PCS			PCS			PCS			PCS			PCS				PCS

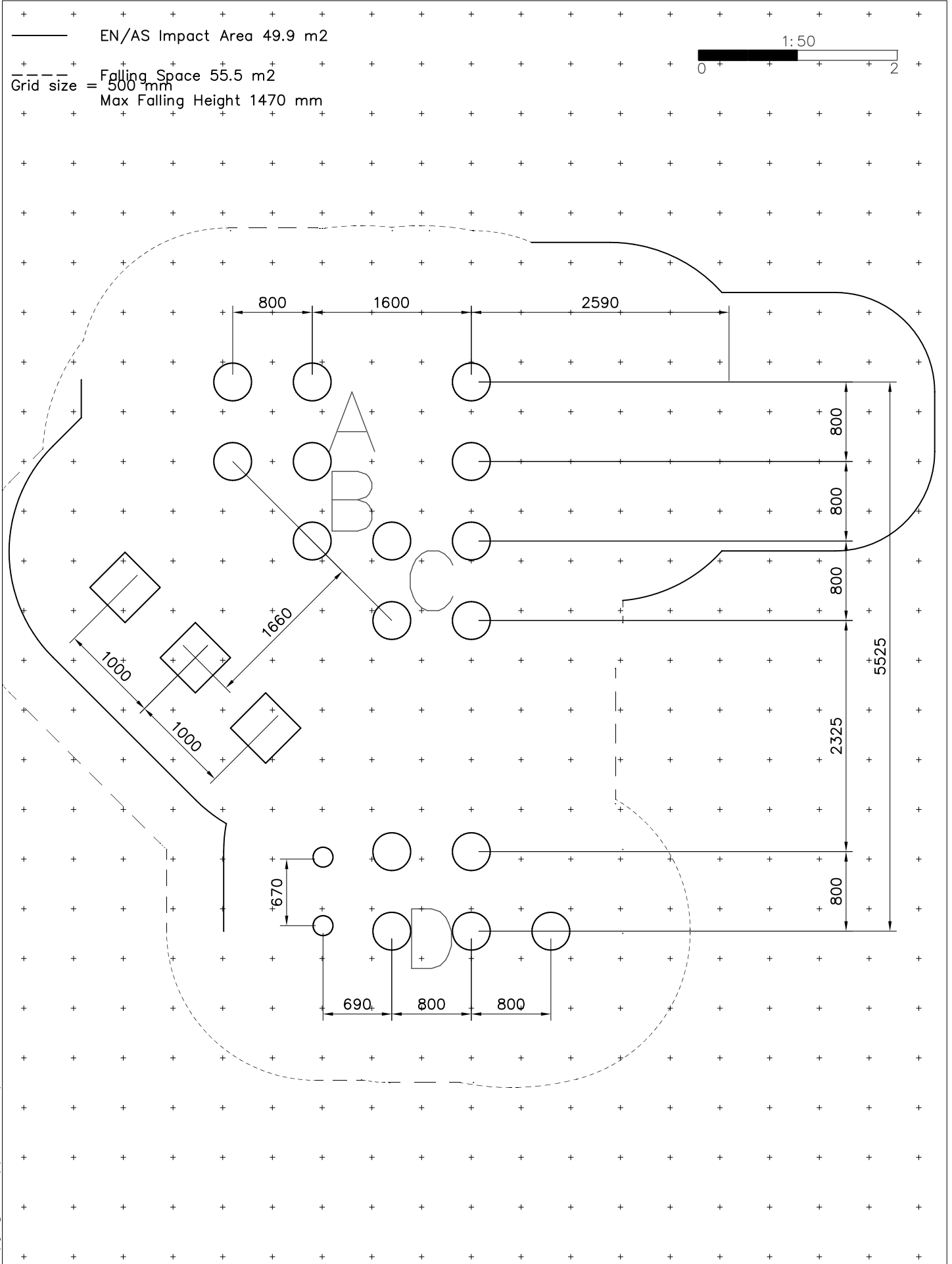

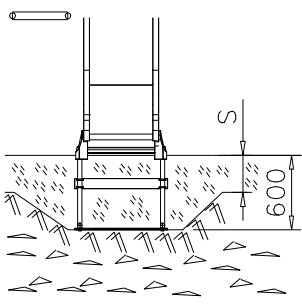
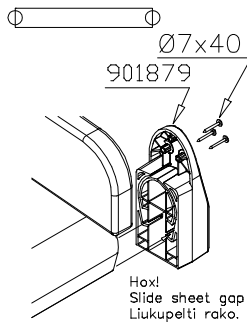
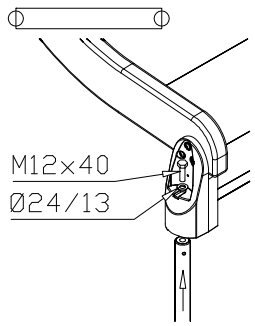
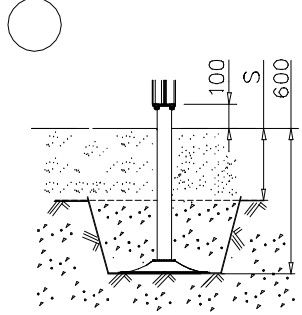
— EN/AS Impact Area 49.9 m²
 - - - Falling Space 55.5 m²
 Max Falling Height 1470 mm



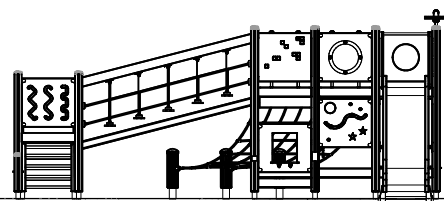
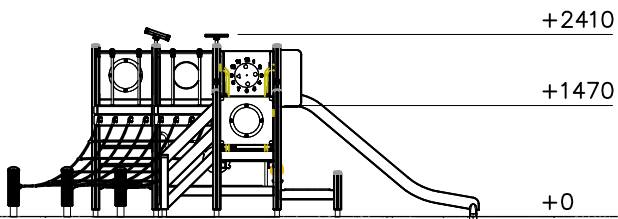
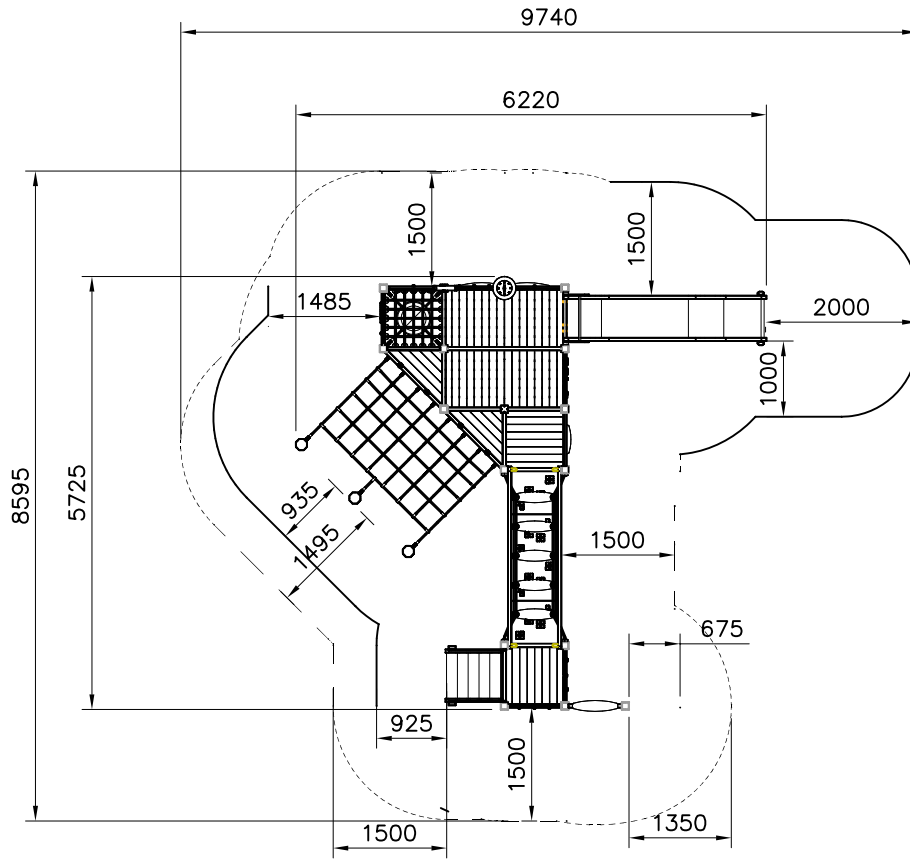

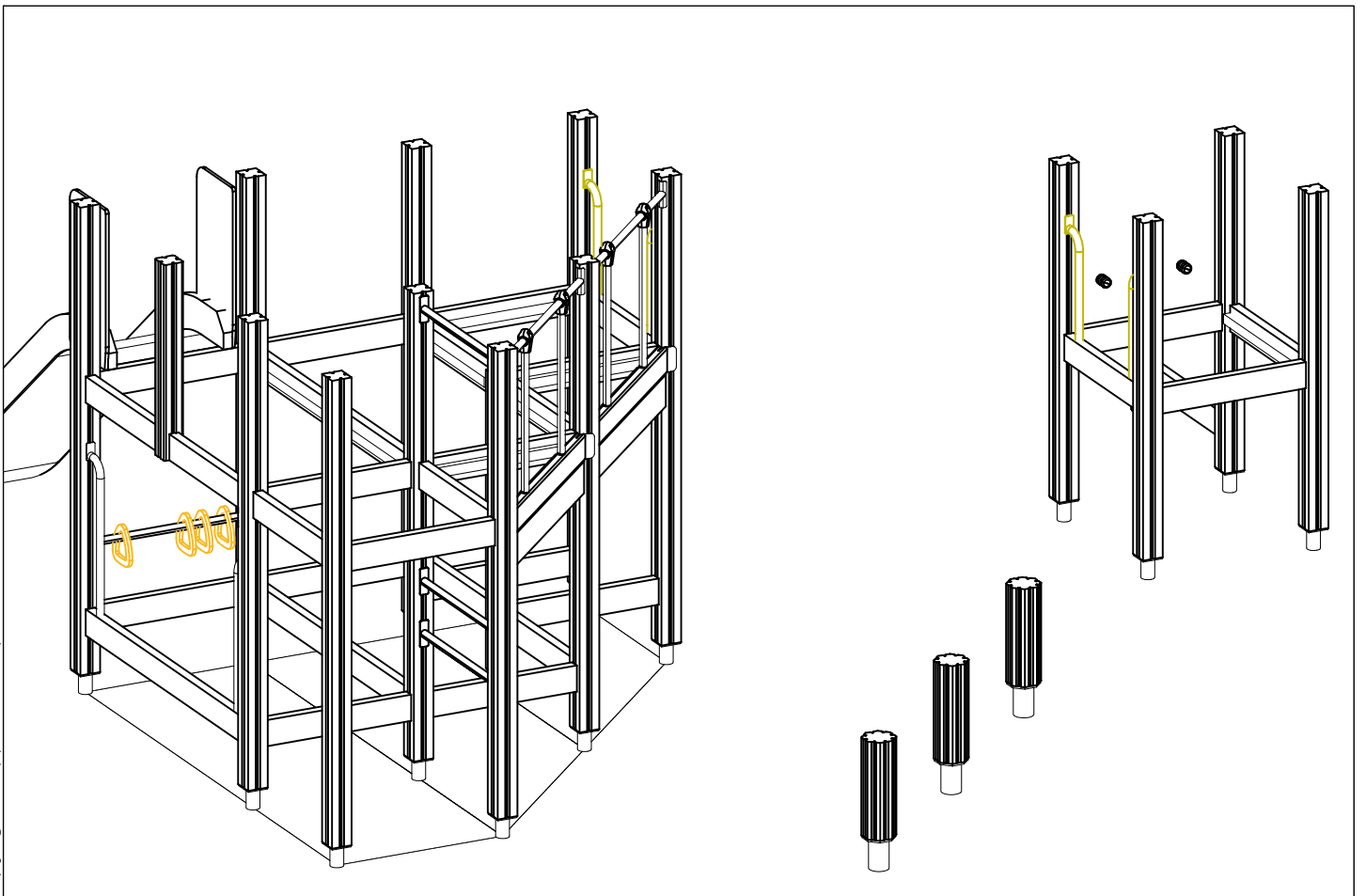
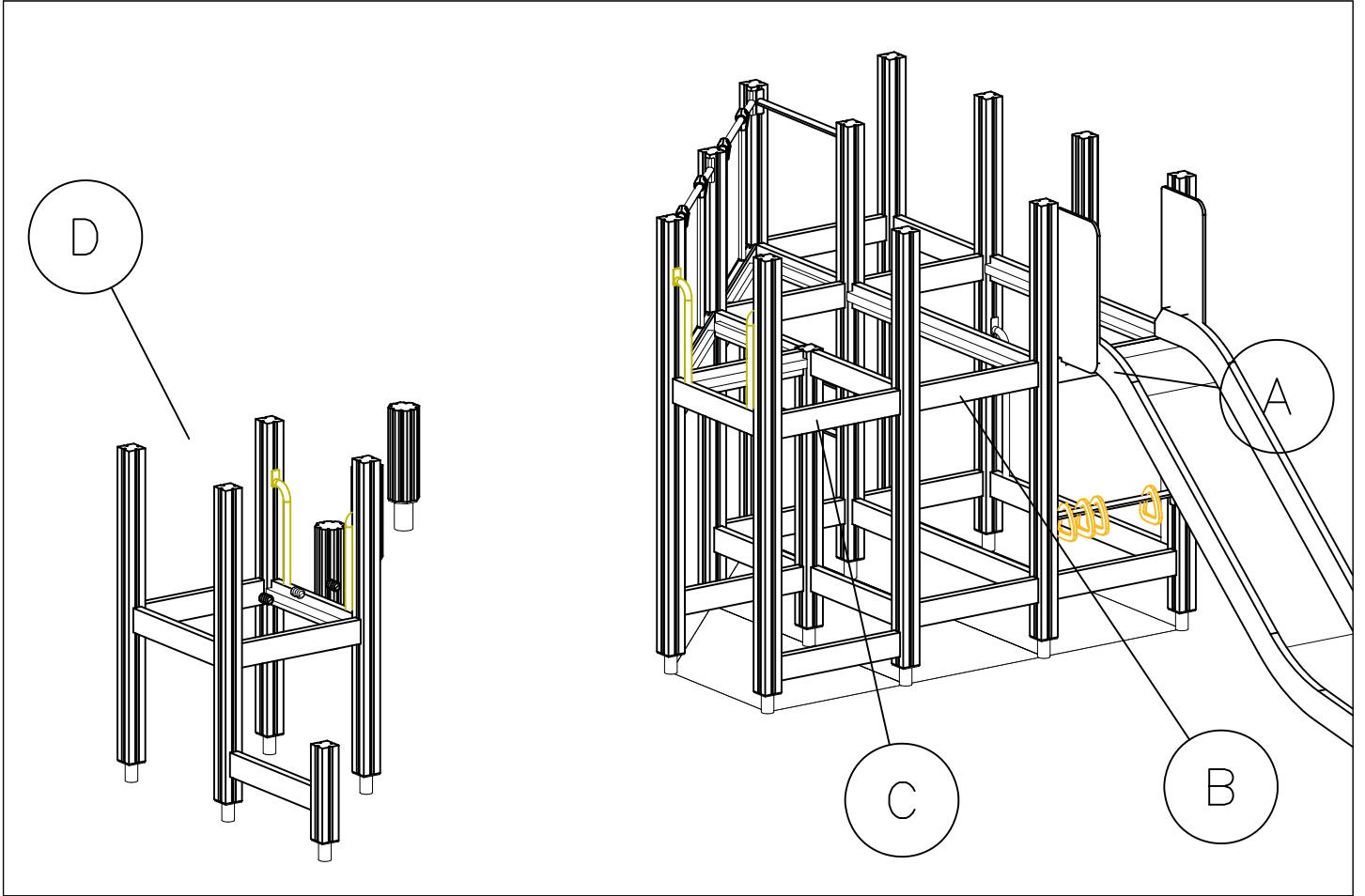
<p>DET 1</p> 	<p>DET 2</p> 	<p>DET 3</p> 	<p>DET 4</p> 
<p>DET 5</p> 	<p>DET 6</p> 	<p>DET 7</p> 	<p>DET 8</p> 
<p>DET 9</p> 	<p>DET 10</p> 		

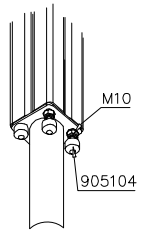
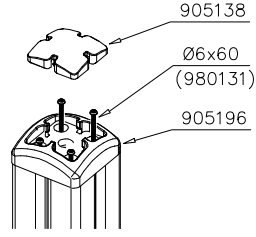
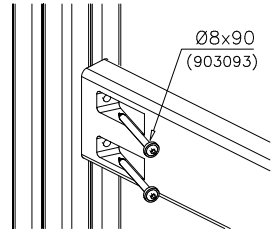
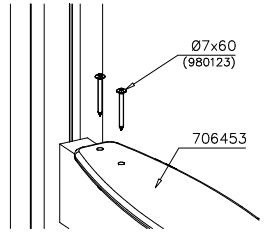
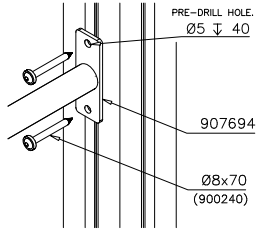
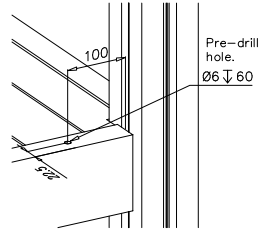
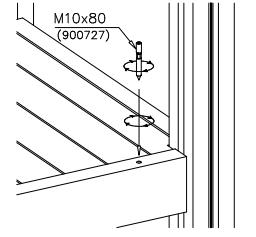
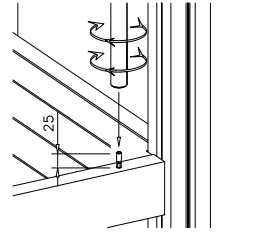
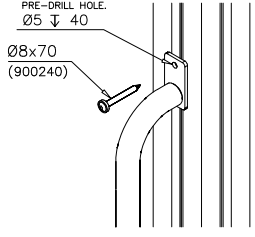
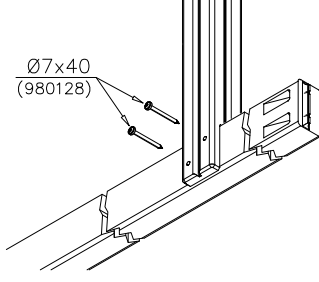
DATE: 31.7.2023

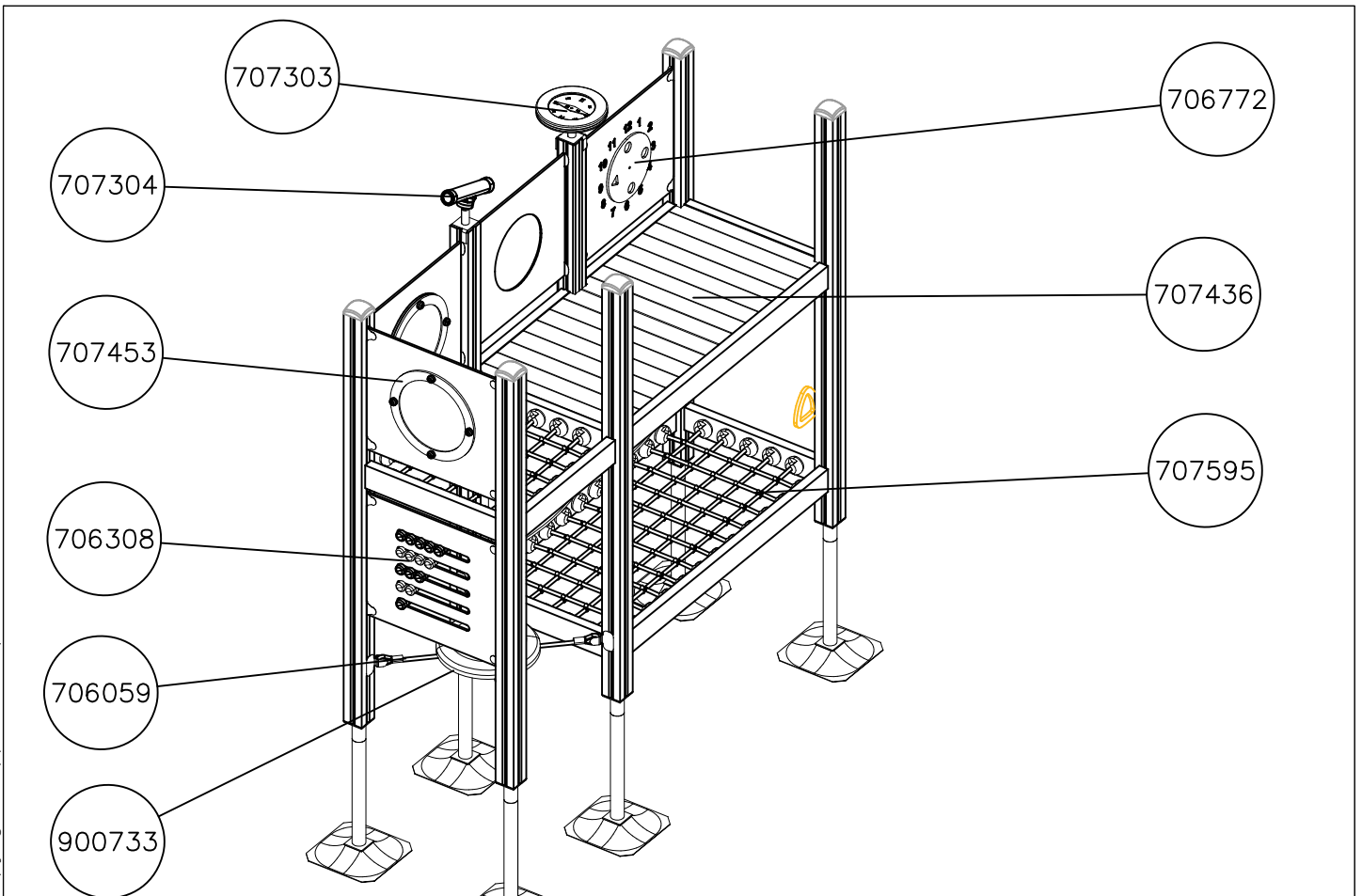
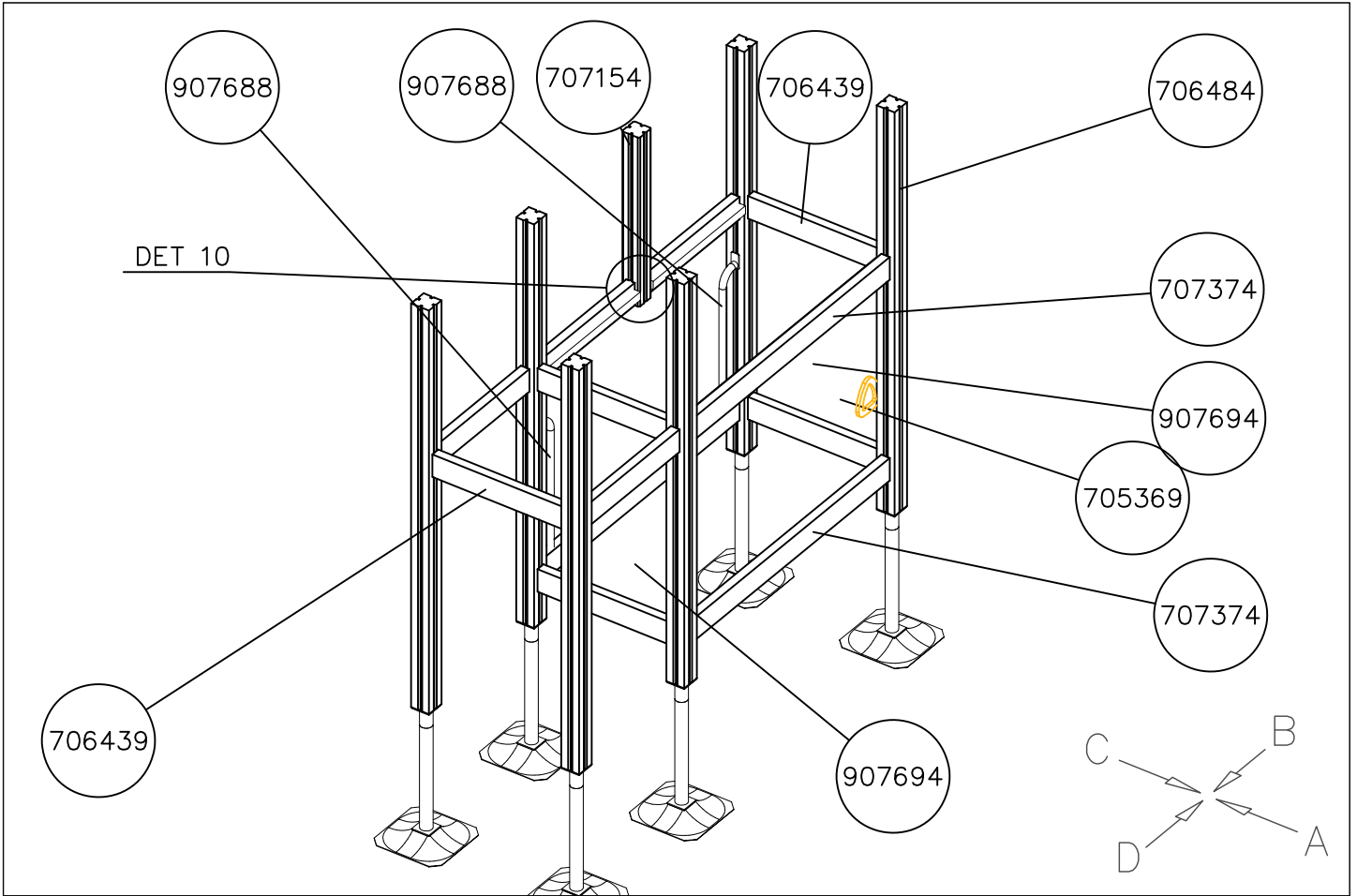

DATE: 31.7.2023

1:50

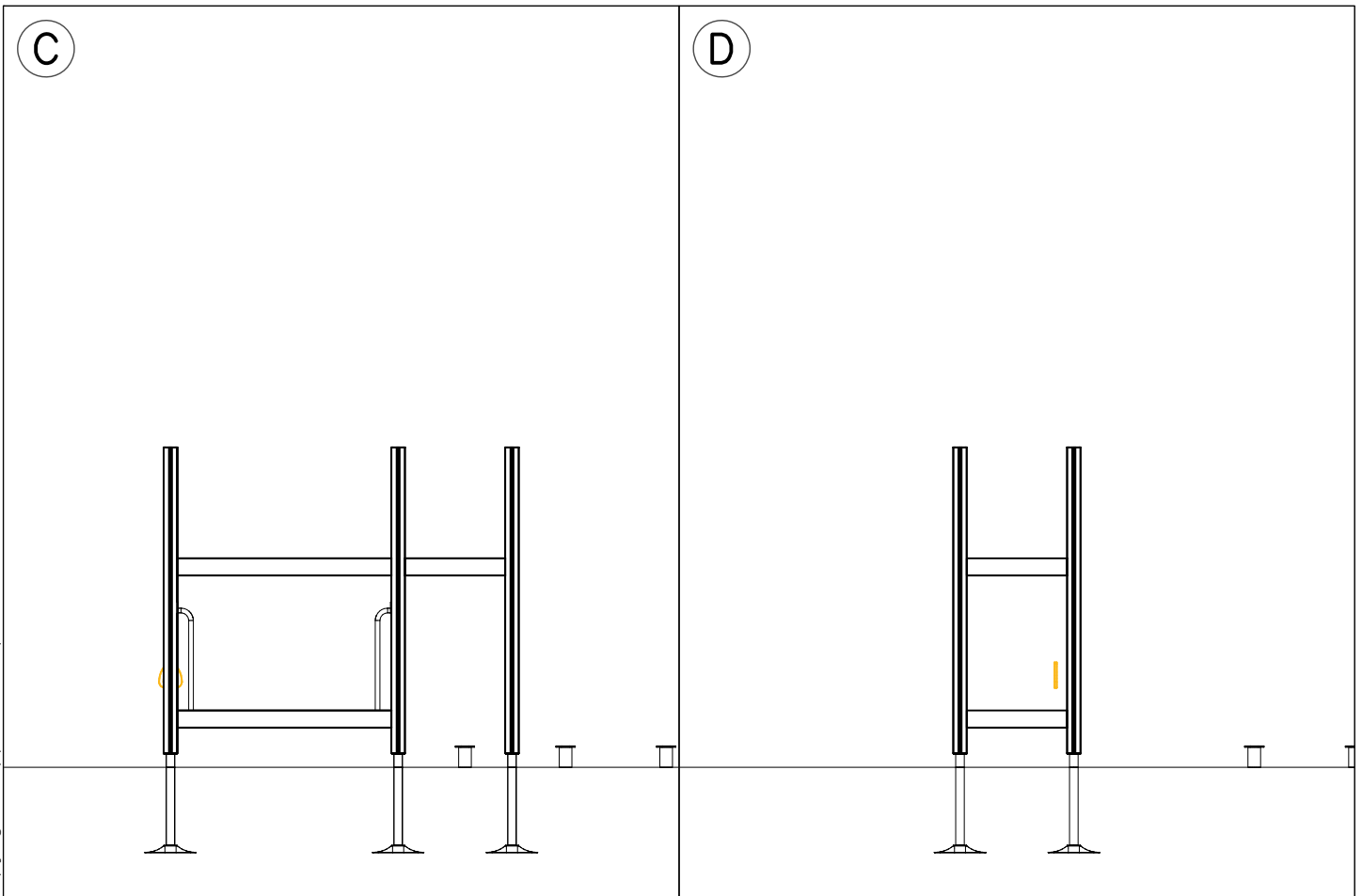
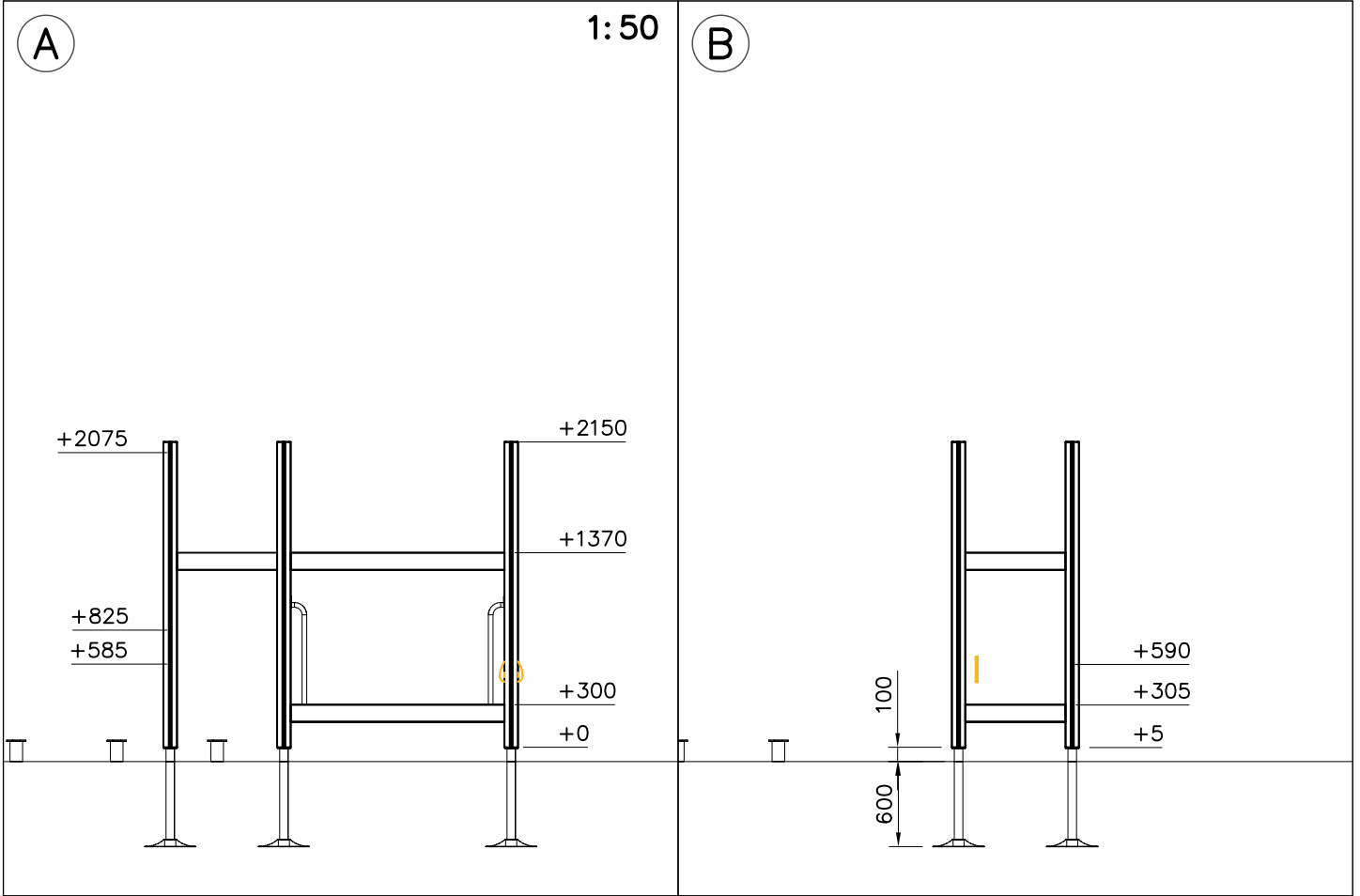

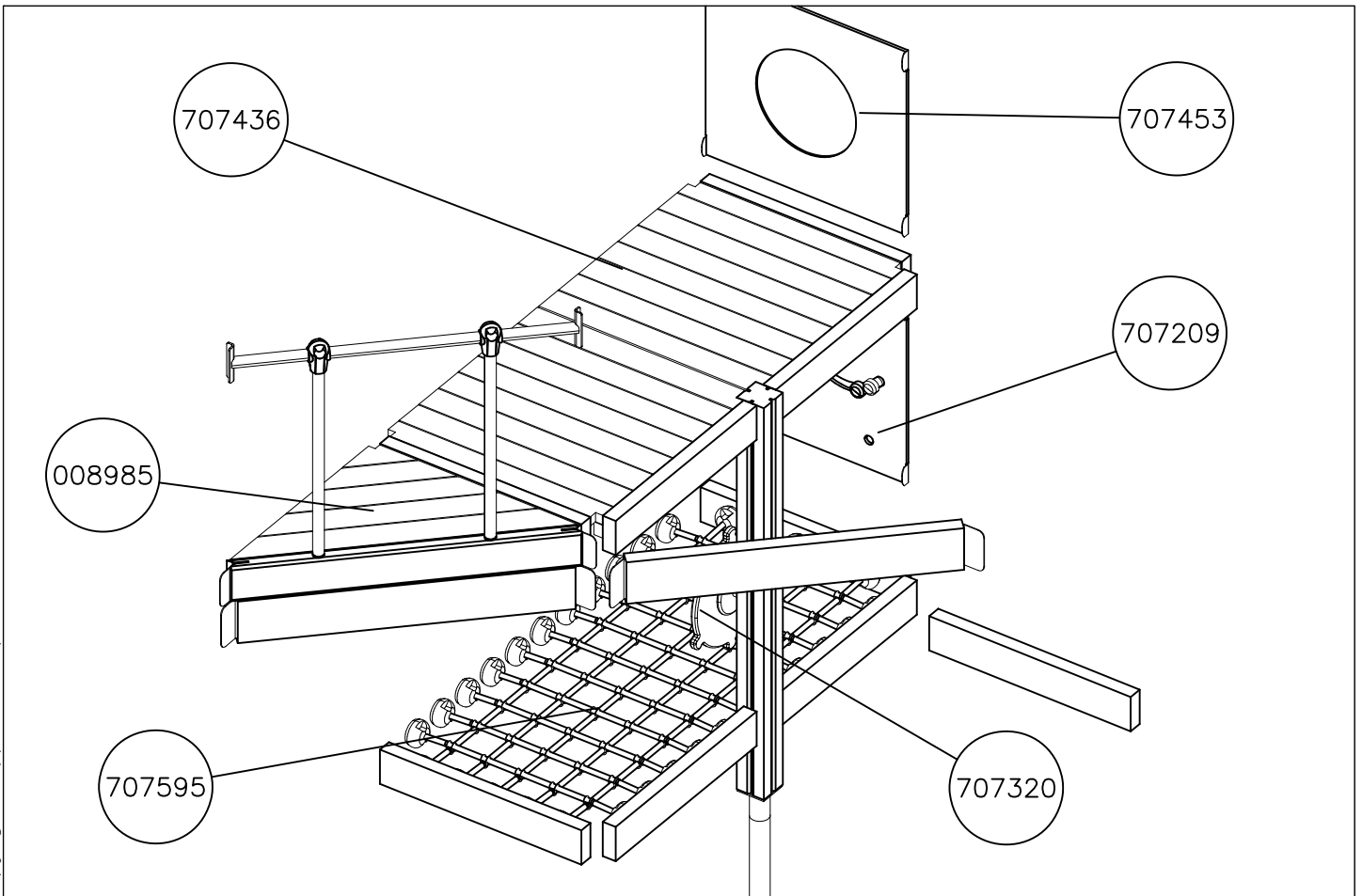
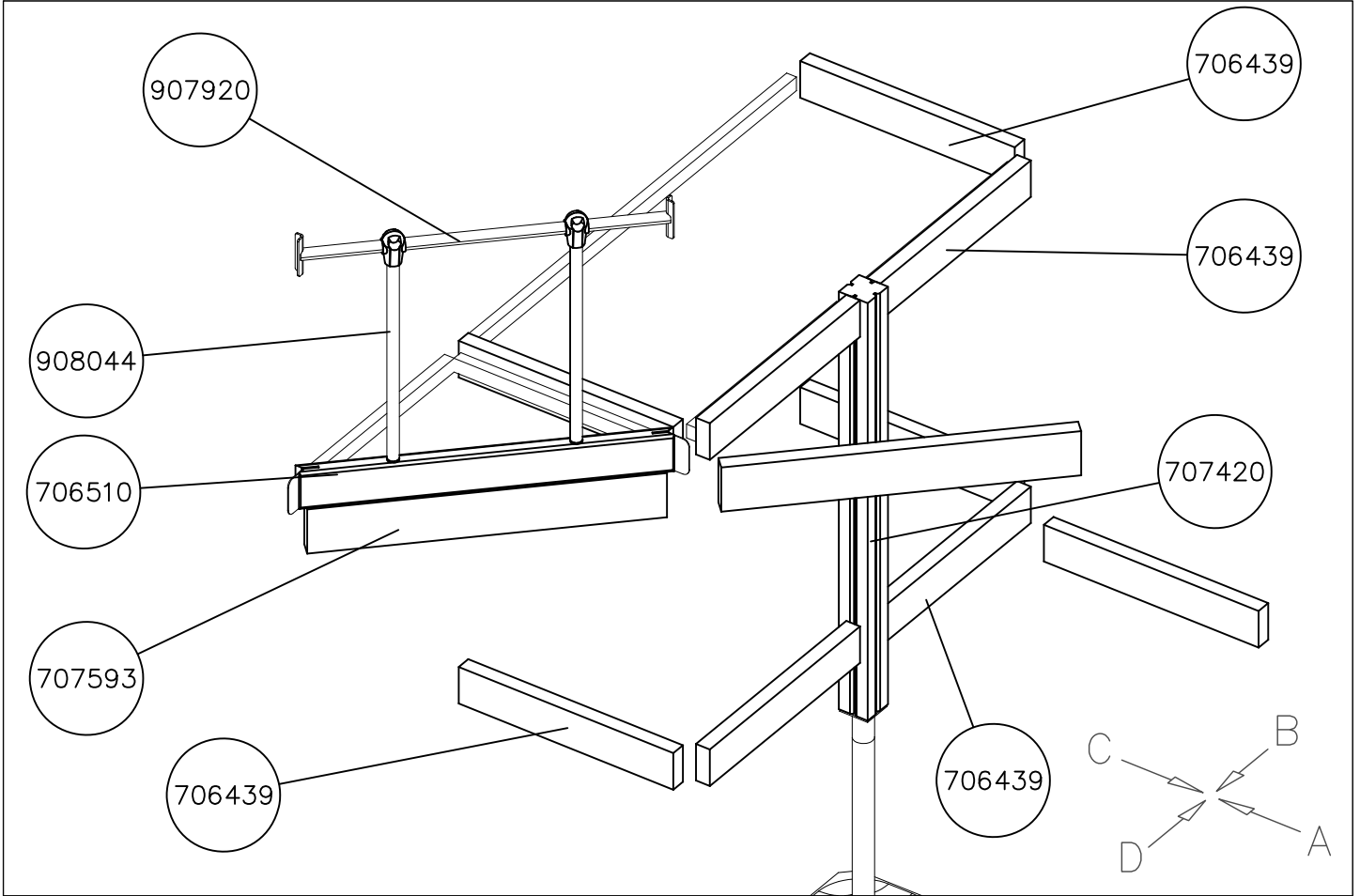

DATE: 31.7.2023

1:50

A

B

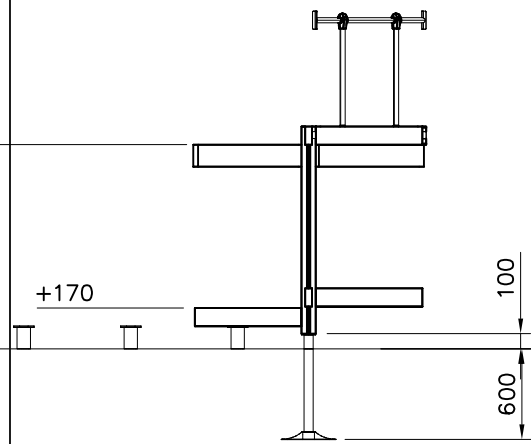
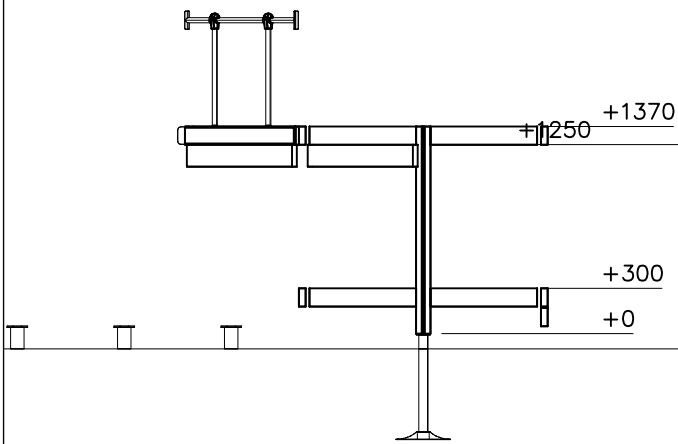

C

D

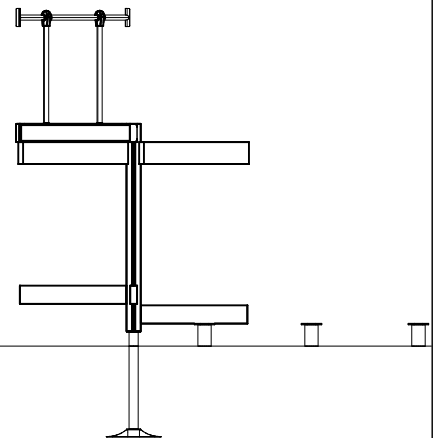
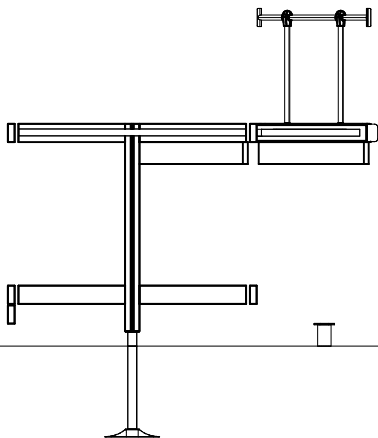

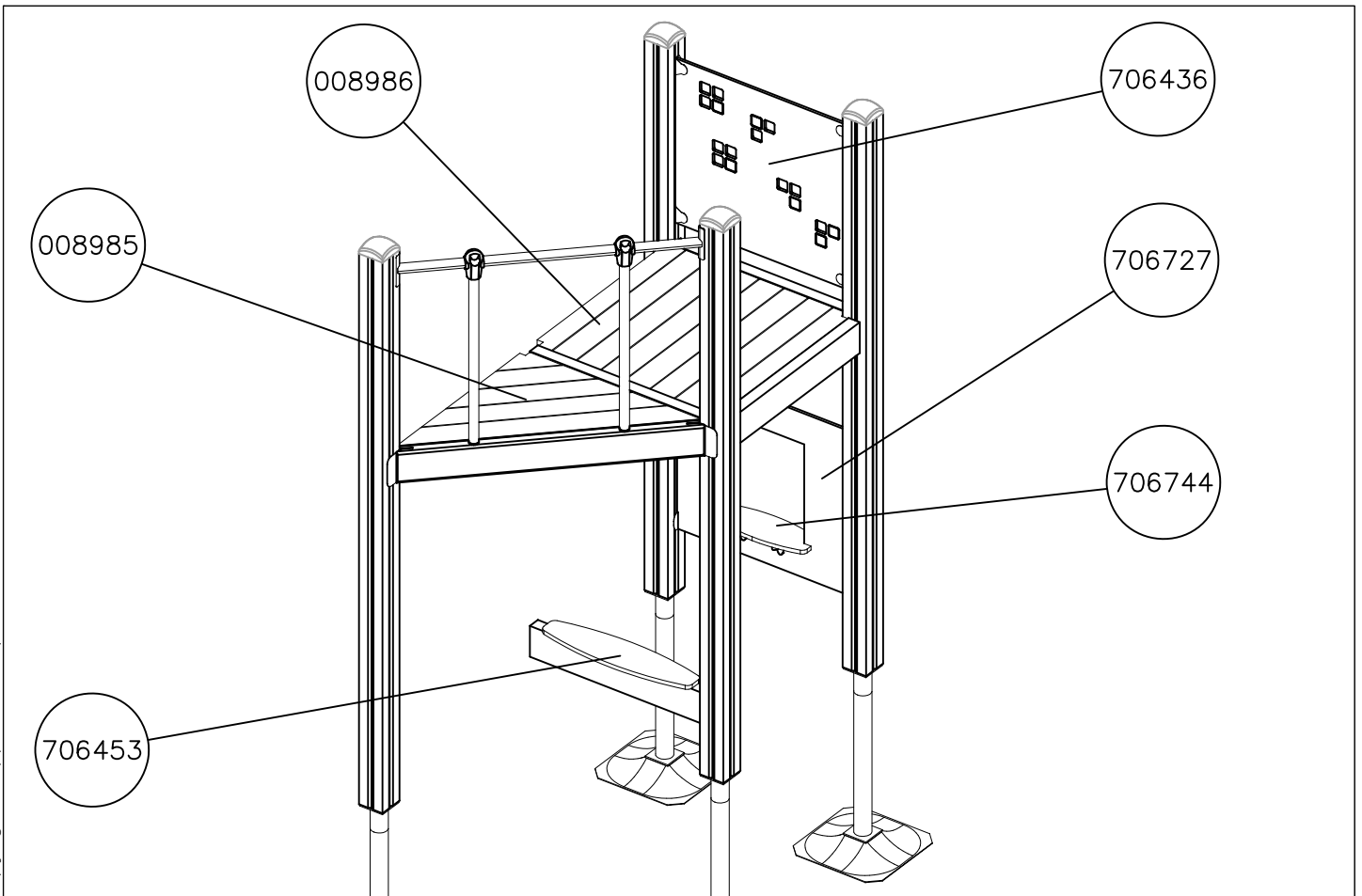
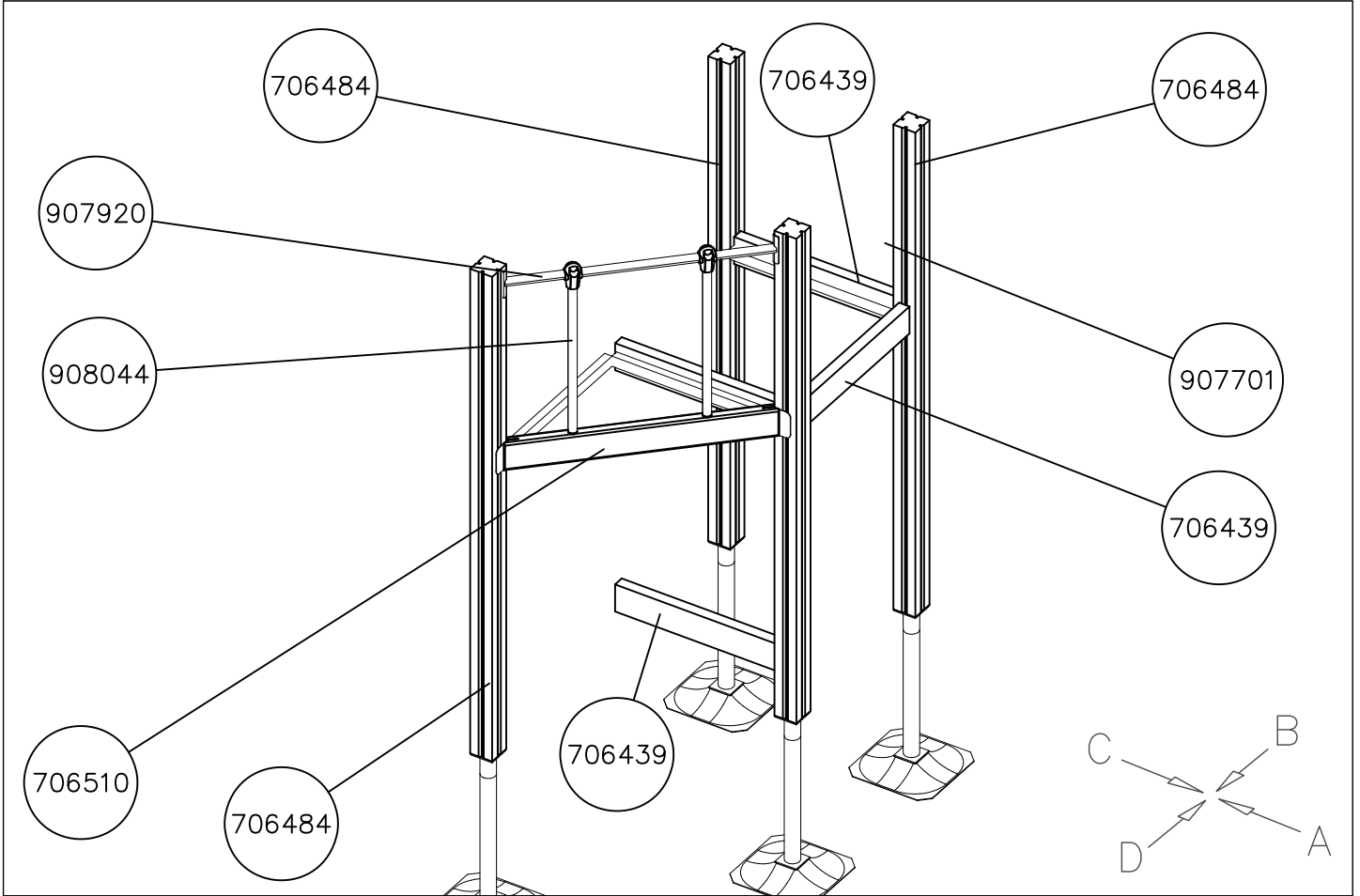

DATE: 31.7.2023

1:50

(A)

(B)

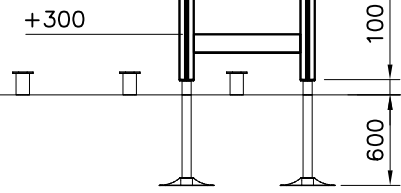
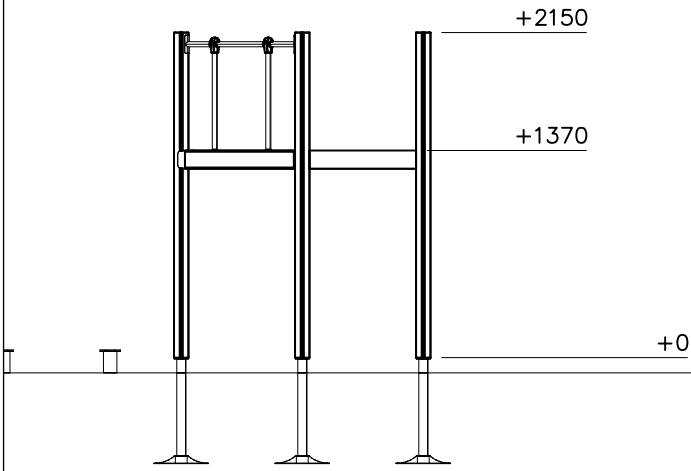

(C)

(D)

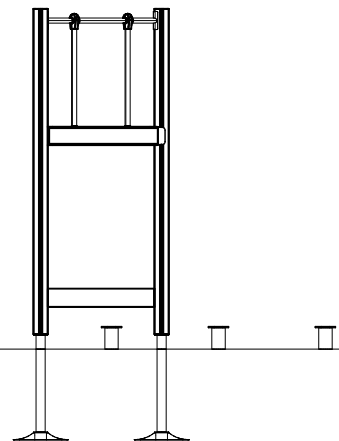
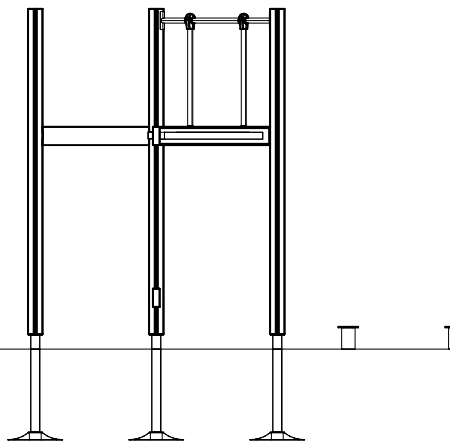

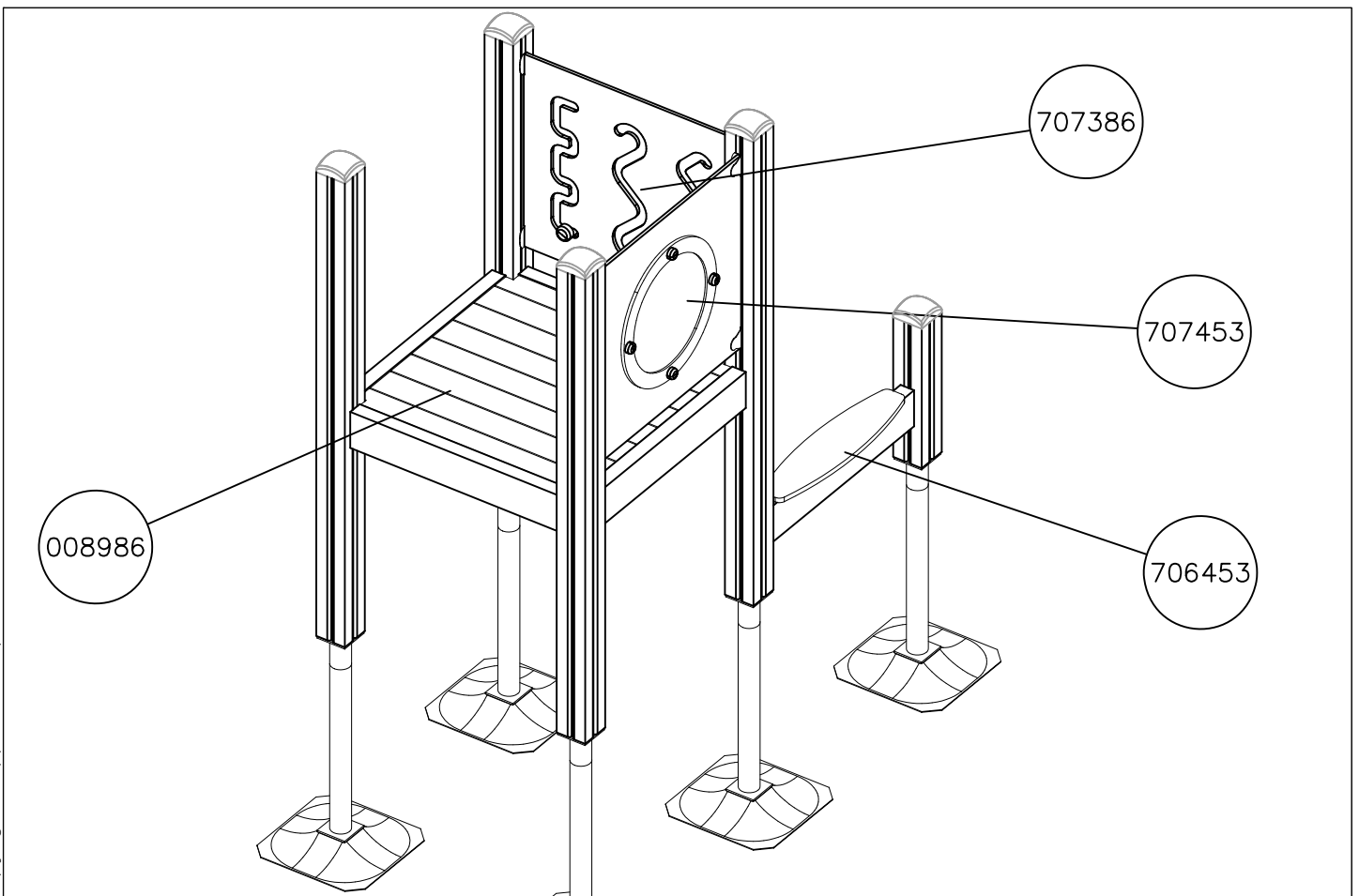
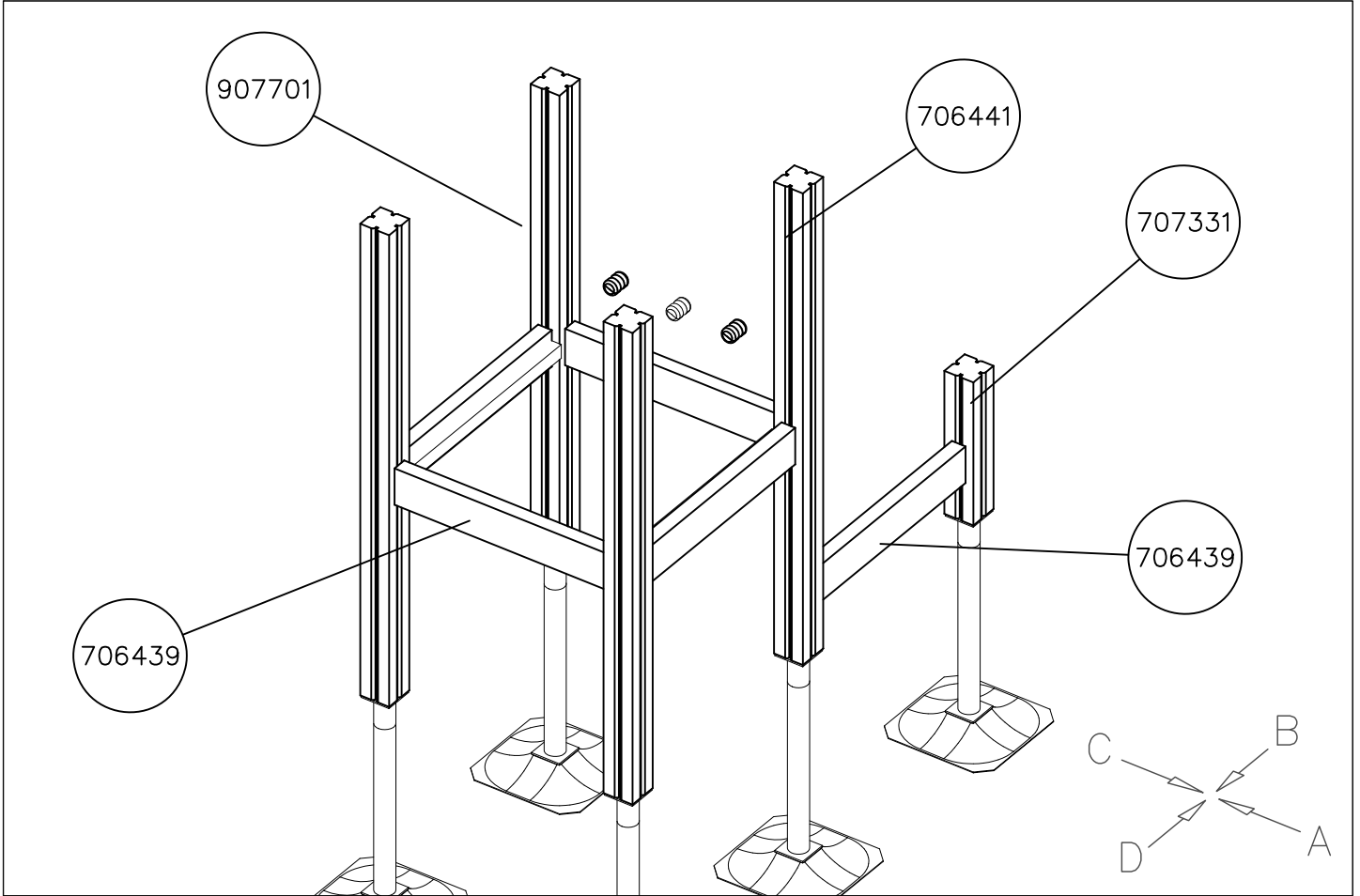

DATE: 31.7.2023

1:50

