

# LAPPSET®

## FINNO







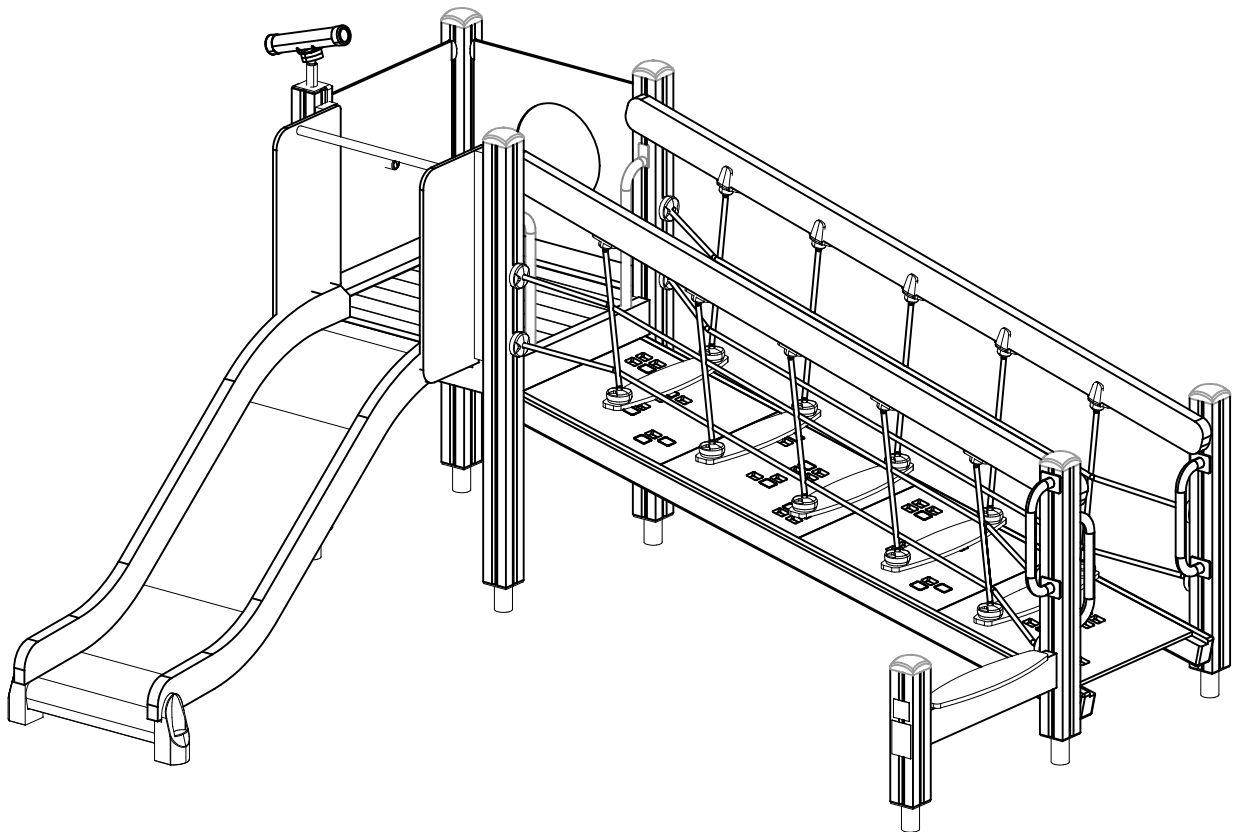

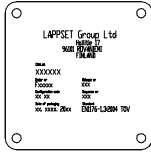
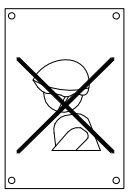

ASENNUSOHJE  
MONTERINGSANSVISNING  
INSTALLATION INSTRUCTION  
AUFBAUANLEITUNG  
NOTICE D'INSTALLATION

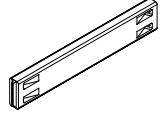
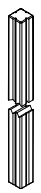
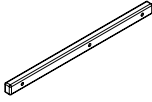
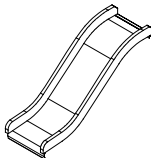
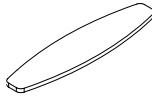
DATE: 28.7.2023

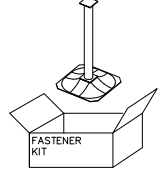
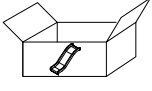
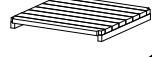
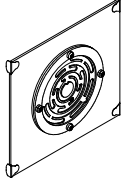
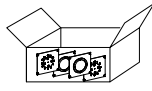
### Q14656-1

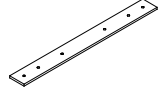
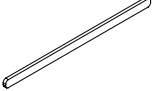
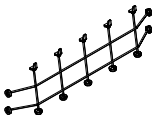
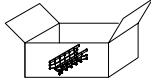
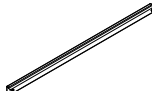
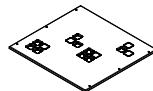
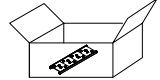
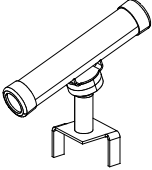
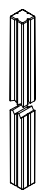
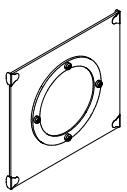
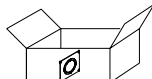
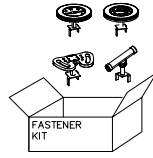
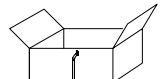
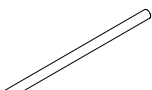

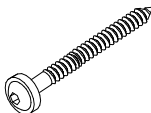
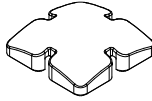
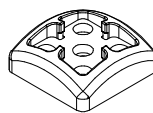
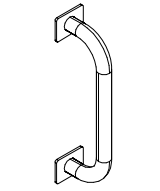
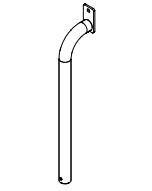
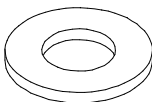
DATE: 28.7.2023

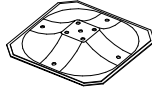
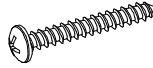
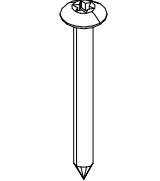
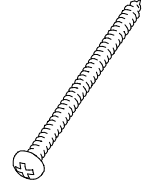
008986  750x750	PCS 1	702286  65x65	PCS 1	702339  118x78	PCS 1	706371-702  15x345x750	PCS 2	706439-602  L 704	PCS 5	706441-602  93x93x1550	PCS 4
706443  32x45x702	PCS 2	706452-602  600x780x1470	PCS 1	706453  15x145x600	PCS 6	706505  35x70x730	PCS 2	706531  FASTENER KIT	PCS 7	706533  FASTENER KIT	PCS 1
706535  FASTENER KIT	PCS 1	706766-702  FASTENER KIT	PCS 1	706778  FASTENER KIT	PCS 1	706894-602  L 950	PCS 2	707133  10x80x745	PCS 1	707255-610  45x120x2480	PCS 2
707260-305  2375x600	PCS 2	707268  FASTENER KIT	PCS 1	707271-602  70x95x2480	PCS 2	707272-702  15x630x590	PCS 4	707284  FASTENER KIT	PCS 1	707304  FASTENER KIT	PCS 1
707331-602  93x93x470	PCS 1	707453-702  10x640x702	PCS 1	707454  FASTENER KIT	PCS 1	707585  FASTENER KIT	PCS 1	707732  FASTENER KIT	PCS 2	901868  Ø34x598	PCS 3
901879  FASTENER KIT	PCS 2	903093  Ø8x90	PCS 20	905138  GRAY	PCS 6	905196  GRAY	PCS 6	906635-217  FASTENER KIT	PCS 3	907701-216  FASTENER KIT	PCS 2
909256  Ø16/8.4x1.6	PCS 12	909511  90x90x650	PCS 7	909519  50x380x380	PCS 7	980114  Ø4x20	PCS 8	980123  Ø7x60	PCS 16	980131  Ø6x60	PCS 24

EN/AS Impact Area 26.9 m<sup>2</sup>

Falling Space 28.7 m<sup>2</sup>  
Grid size = 500 mm  
Max Falling Height 1000 mm

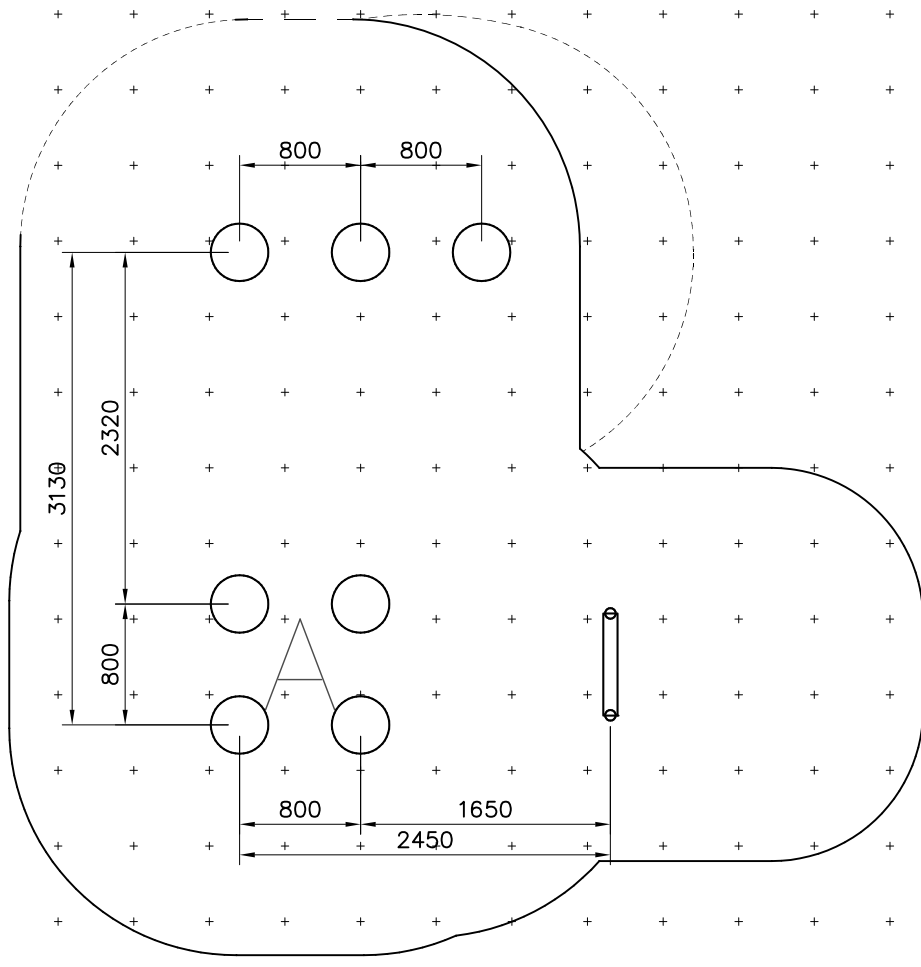
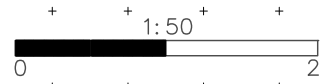

<p>M10 905104</p>	<p>100 S 600</p>	<p>S 600</p>
<p>Ø7x40 901879</p> <p>Hox! Slide sheet gap Liukupelti rako.</p>	<p>M12x40 Ø24/13</p>	

- EN/AS Impact Area 26.9 m<sup>2</sup>
- Falling Space 28.7 m<sup>2</sup>
- Max Falling Height 1000 mm

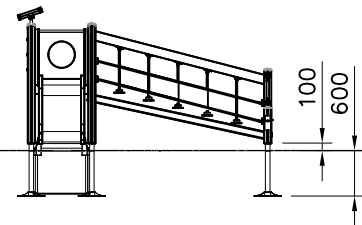
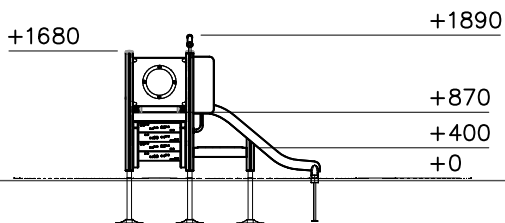
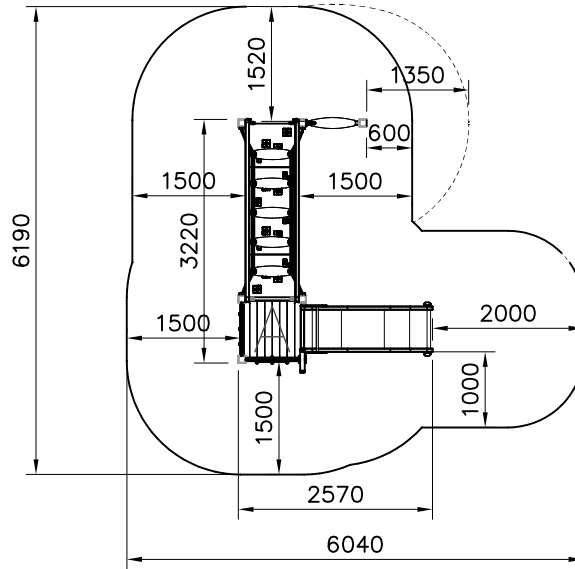

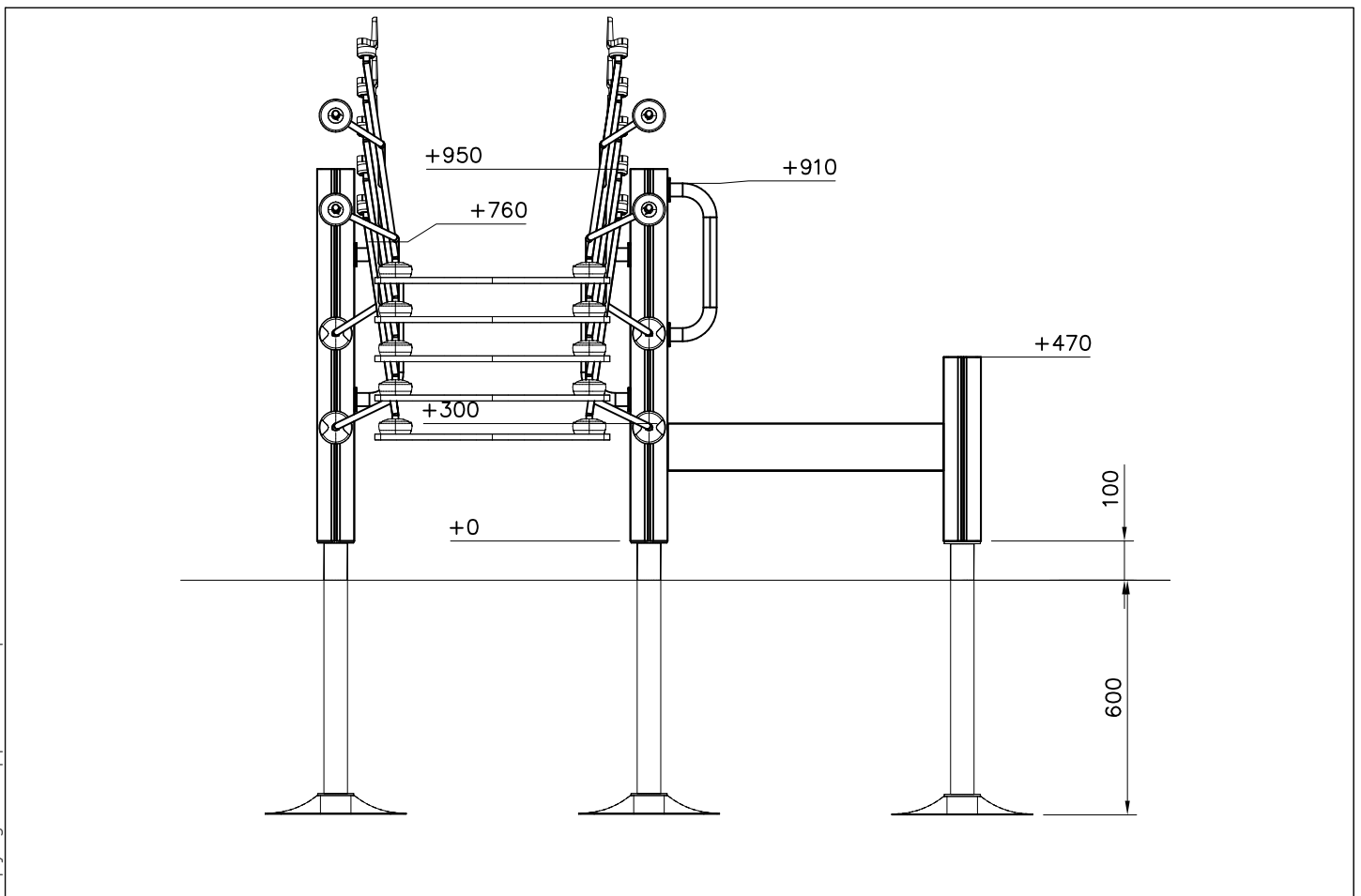
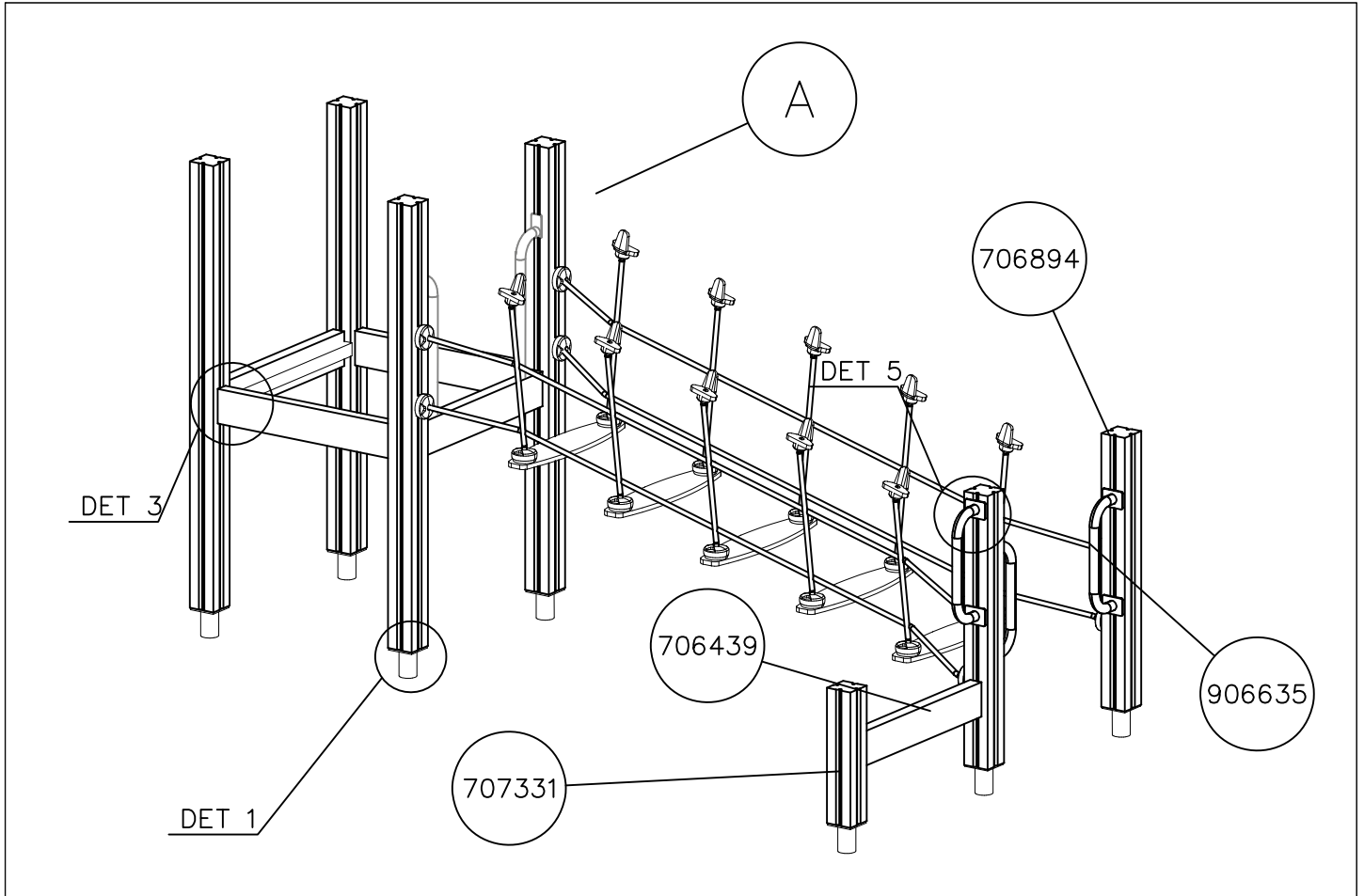

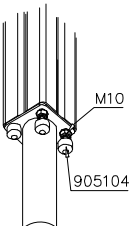
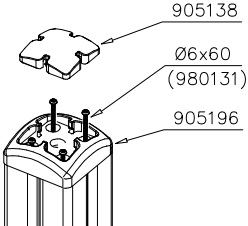
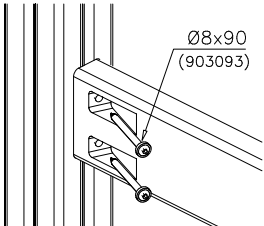
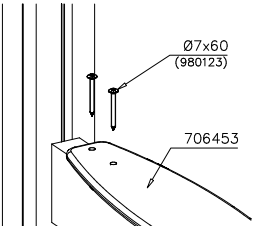
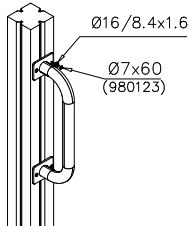
<p>DET 1</p> 	<p>DET 2</p> 	<p>DET 3</p> 	<p>DET 4</p> 
<p>DET 5</p> 	<p>DET 6</p>	<p>DET 7</p>	<p>DET 8</p>
<p>DET 9</p>			

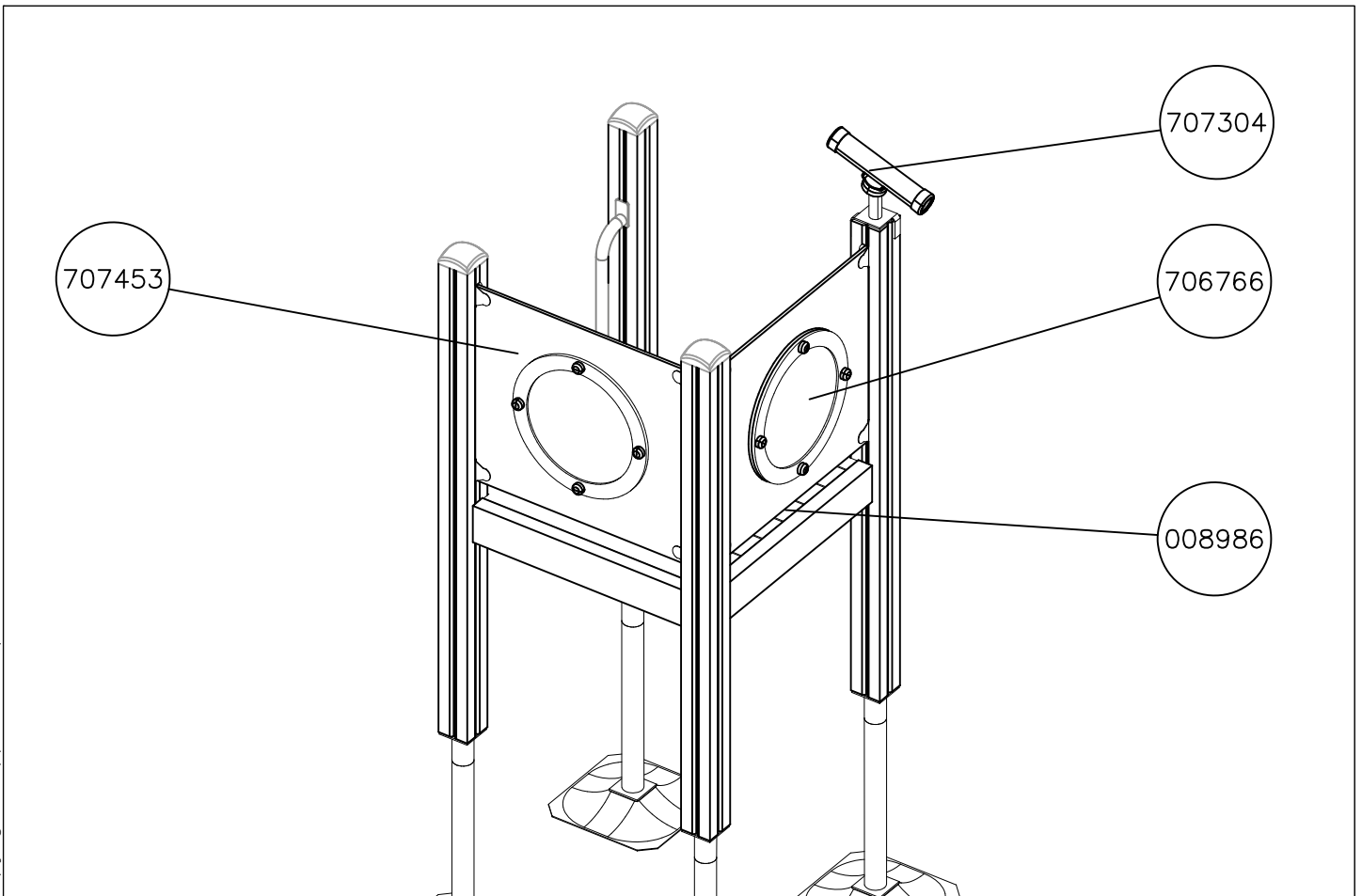
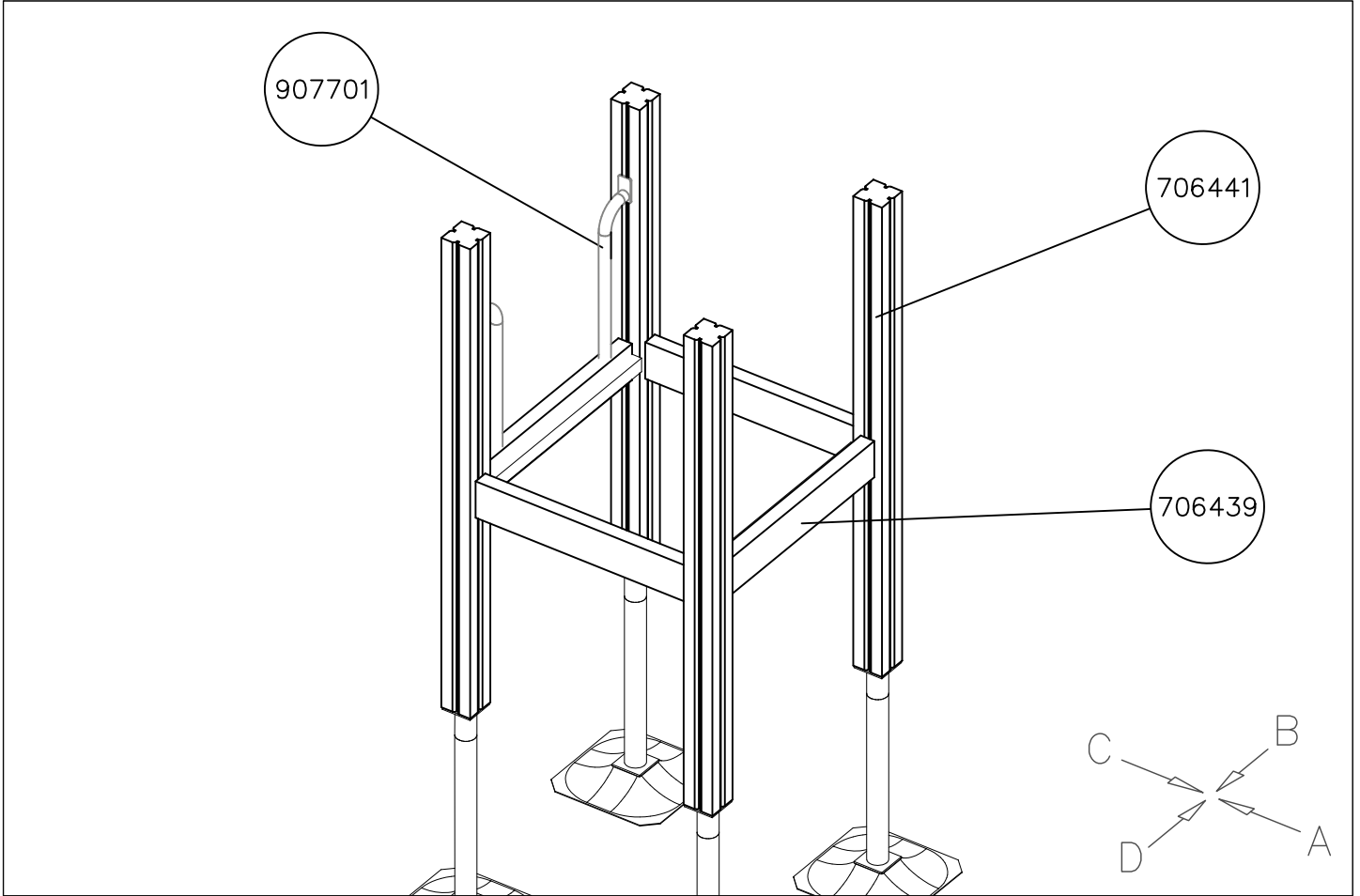



DATE: 28.7.2023

1:50

A

B

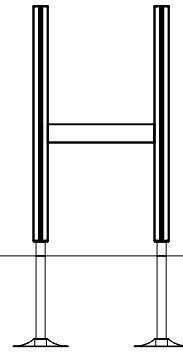
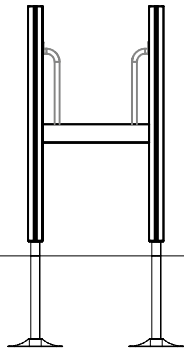

C

D

