

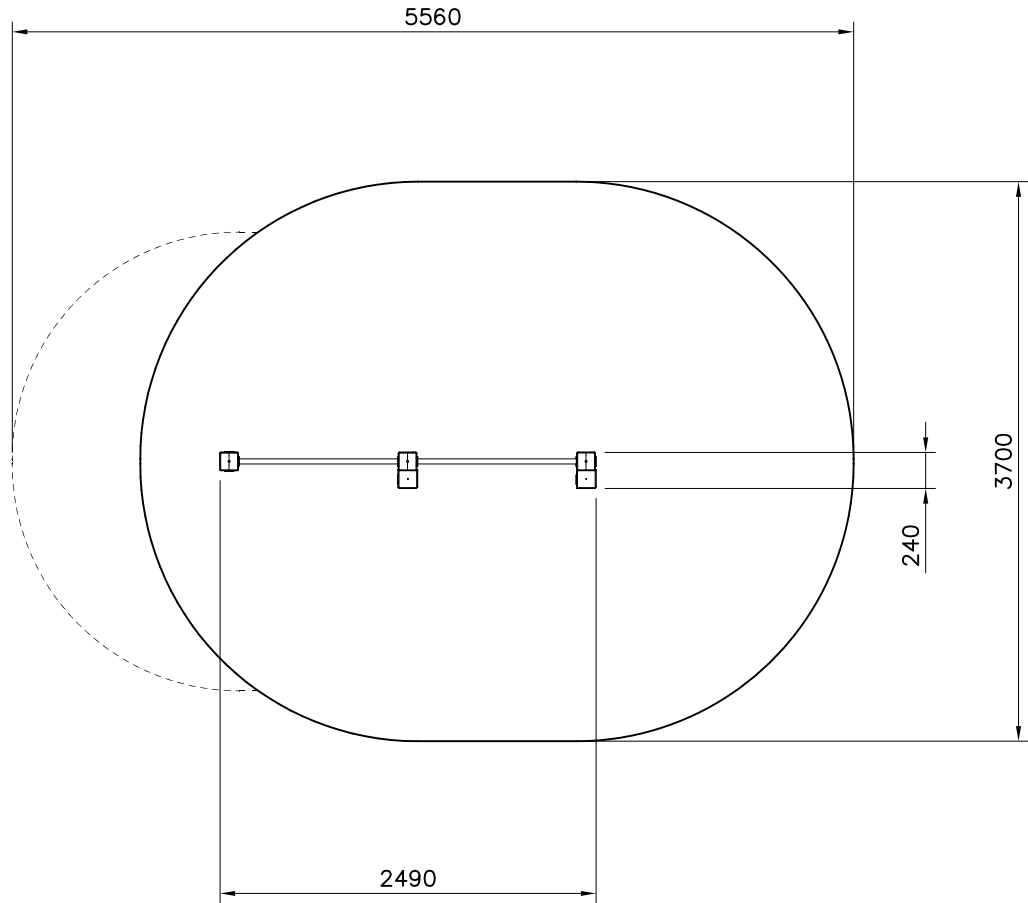

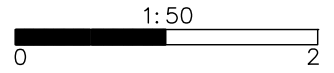



- EN/AS Impact Area 14.6 m²
- - - - Falling Space 16.9 m²
Max Falling Height 1000 mm

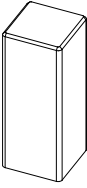

DATE: 16.12.2019

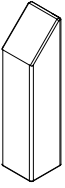
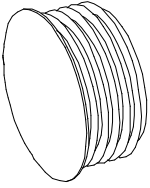
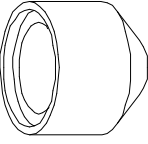
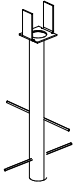
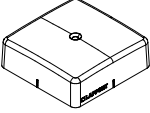
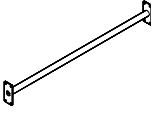
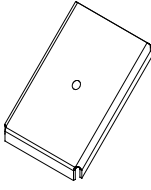
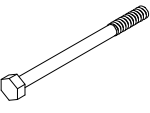
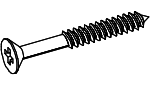
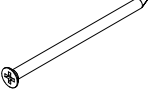
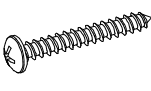
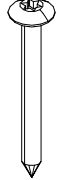
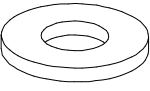
702286  65x65	PCS 1	705335  118x118x1000	PCS 1	705349  118x118x400	PCS 1	705388  118x118x2090	PCS 2	705405  118x118x500	PCS 1	905103  PT -28/32-H	PCS 6
905104  M10	PCS 20	905761  120x120x700	PCS 5	905830  123x123x40	PCS 3	905838-216  L 1060	PCS 2	906583  129x181x14x3	PCS 2	909246  Ø12x140	PCS 6
909256  Ø16/8.4	PCS 32	980100  Ø5x60	PCS 2	980104  Ø5x90	PCS 3	980114  Ø4x20	PCS 4	980123  Ø7x60	PCS 36	980154  Ø24/13	PCS 6
	PCS		PCS		PCS		PCS		PCS		PCS
	PCS		PCS		PCS		PCS		PCS		PCS
	PCS		PCS		PCS		PCS		PCS		PCS
	PCS		PCS		PCS		PCS		PCS		PCS