

LAPPSET®

CUBIC







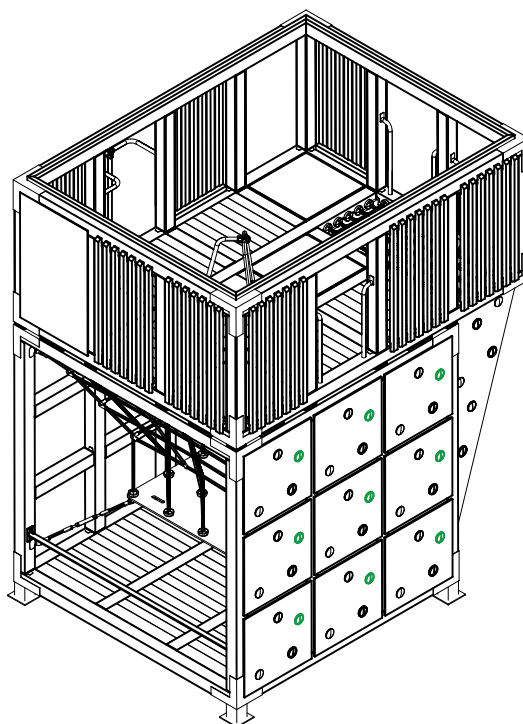



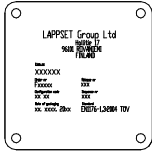
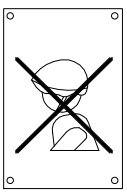
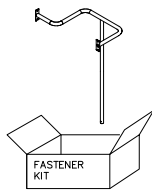
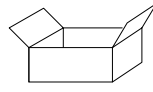
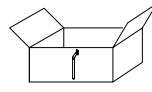
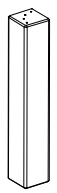

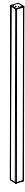



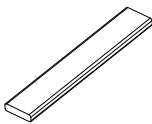
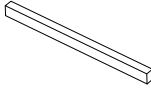
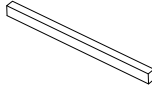

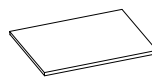
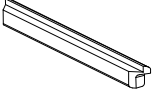
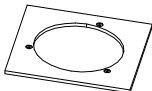
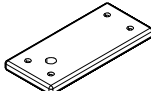
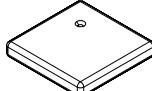
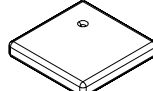
ASENNUSOHJE
MONTERINGSANSVISNING
INSTALLATION INSTRUCTION
AUFBAUANLEITUNG
NOTICE D'INSTALLATION

DATE: 15.11.2019

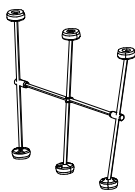

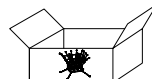
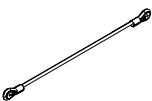

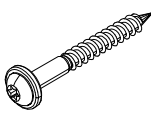
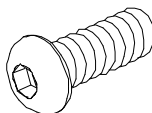
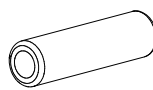
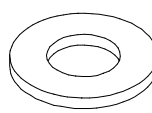
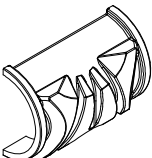
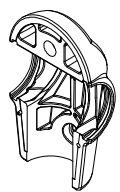
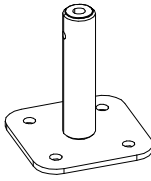
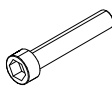
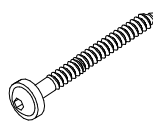





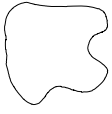

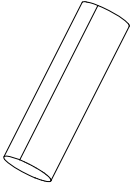

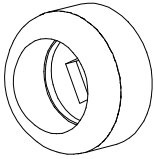
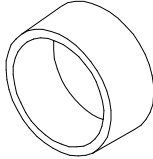
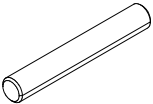

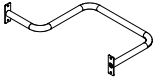
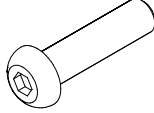
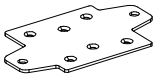
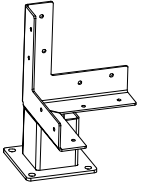
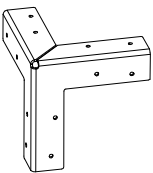
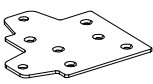
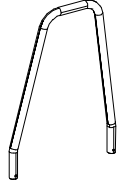

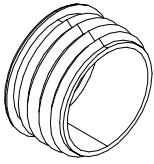
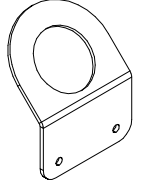
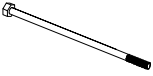

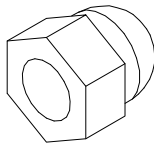
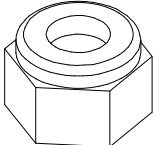
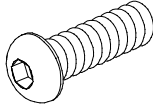
Q14099

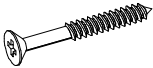

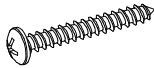
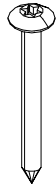
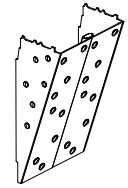
DATE: 15.11.2019

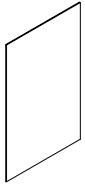
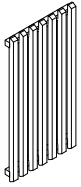
702286  65x65	PCS 1	702339  118x78	PCS 1	706541  FASTENER KIT	PCS 1	706830 	PCS 1	707732 	PCS 6	708109-614  118x118x697	PCS 27
708110-614  118x118x1522	PCS 1	708111-614  118x118x2345	PCS 14	708114-614  118x118x3168	PCS 1	708194-614  118x118x2573	PCS 12	708202-614  118x118x3396	PCS 4	708221  701x695x32	PCS 14
708223  32x120x700	PCS 6	708225  32x45x640	PCS 36	708226  32x45x793	PCS 12	708228  8x785x785	PCS 12	708230  20x670x670	PCS 4	708234-614  45x68x700	PCS 16
708244  20x702x702	PCS 1	708258  20x118x260	PCS 32	708301  15x118x118	PCS 8	708302  20x118x118	PCS 8	708676-305  2336x2336x1604	PCS 1	708683-704  15x750x750	PCS 1
708684-704  15x1300x1300	PCS 1	708704-305  L925	PCS 2	708706-305  L925	PCS 4	708708-305  TIGHTENER	PCS 2	708711  L885	PCS 1	708775-305  L885	PCS 2
709380-305  Ø8x70	PCS 1	900240  Ø8x70	PCS 704	900342  M8x16	PCS 2	901182  Ø11/M8x40	PCS 1	901302  Ø20/10.5	PCS 39	901900  Ø11/M8x40	PCS 2
901902  30.7x60.9x100	PCS 4	901920  150x130x130	PCS 1	902232  M10x55	PCS 36	903093  Ø8x90	PCS 64	904297 	PCS 9	904298 	PCS 9

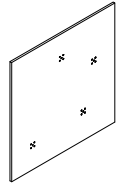
DATE: 15.11.2019

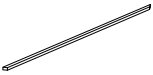
904301  PCS 9 Ø6x20	904302  PCS 9	904336  PCS 36 Ø6x20	904450  PCS 16 M16x170	905090  PCS 36 Ø45	905115  PCS 36 Ø30
905984  PCS 16 Ø12x80	907688-216  PCS 6	907695-216  PCS 1	907727  PCS 3 M10x40	908699  PCS 98 3x180x108	908828-221  PCS 4 336x336x445
908829-221  PCS 12 5x300x300x300	908835  PCS 16 3x144x144	908966-216  PCS 1	908967-216  PCS 1	908969  PCS 32 Ø35	909027  PCS 4 5x140x202
909134  PCS 16 M12x240	909248  PCS 16 M12	909253  PCS 32 Ø32/13.5	909633  PCS 1 M8	909637  PCS 36 M10	909850  PCS 1 M8x25
910997  PCS 1 L3431	980100  PCS 692 Ø5x60	980101  PCS 192 Ø4.5x70	980114  PCS 8 Ø4x20	980123  PCS 228 Ø7x60	A10414  PCS 1
P13584  PCS 14 118x118x1176	P13586  PCS 2 8x785x1262	P13589  PCS 8 1262x785	P13593  PCS 1 2350x130x60	P13595  PCS 9 12x785x785	P13606  PCS 2 40x40x3254
P13607  PCS 2 40x40x2431					

- EN/AS Impact Area 56.8 m²
- Falling Space 56.8 m²
Max Falling Height 2890 mm

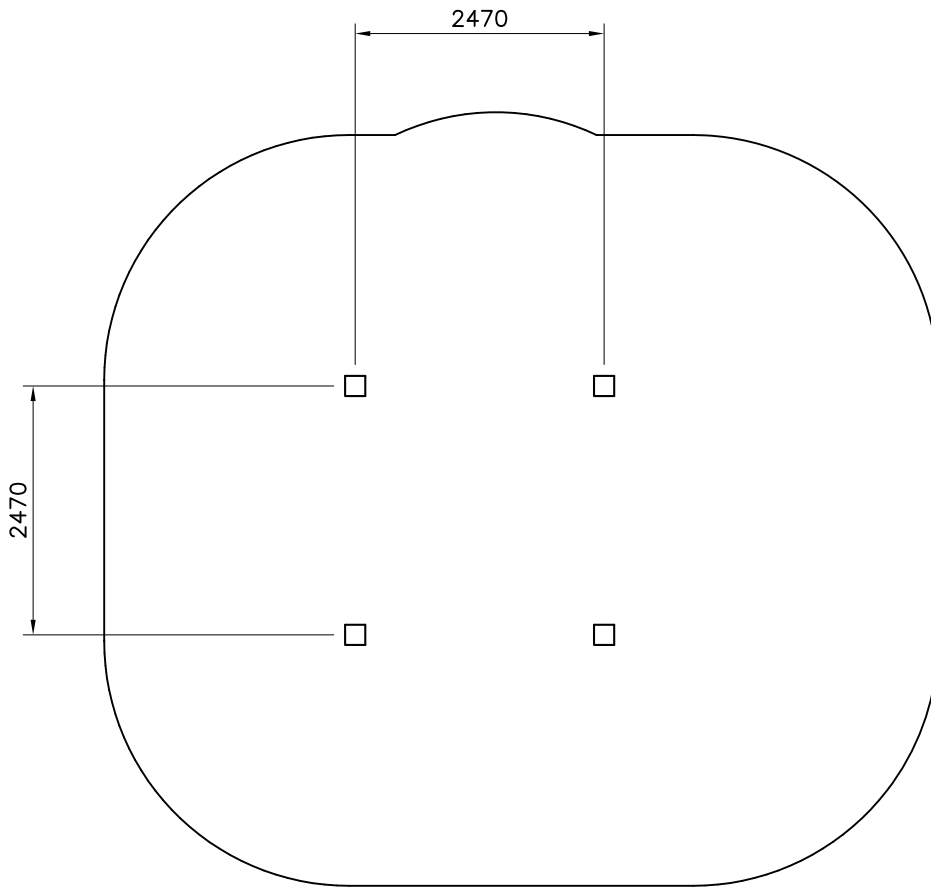
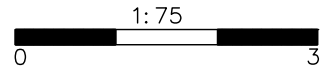

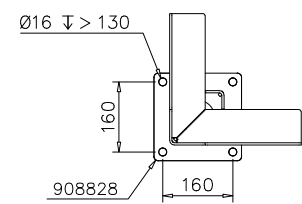
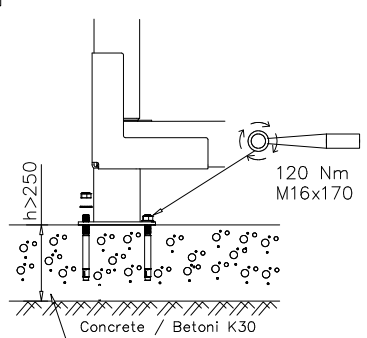
<p><input type="checkbox"/></p> 	<p><input type="checkbox"/></p> 	

- EN/AS Impact Area 56.8 m²
- - - Falling Space 56.8 m²
Max Falling Height 2890 mm

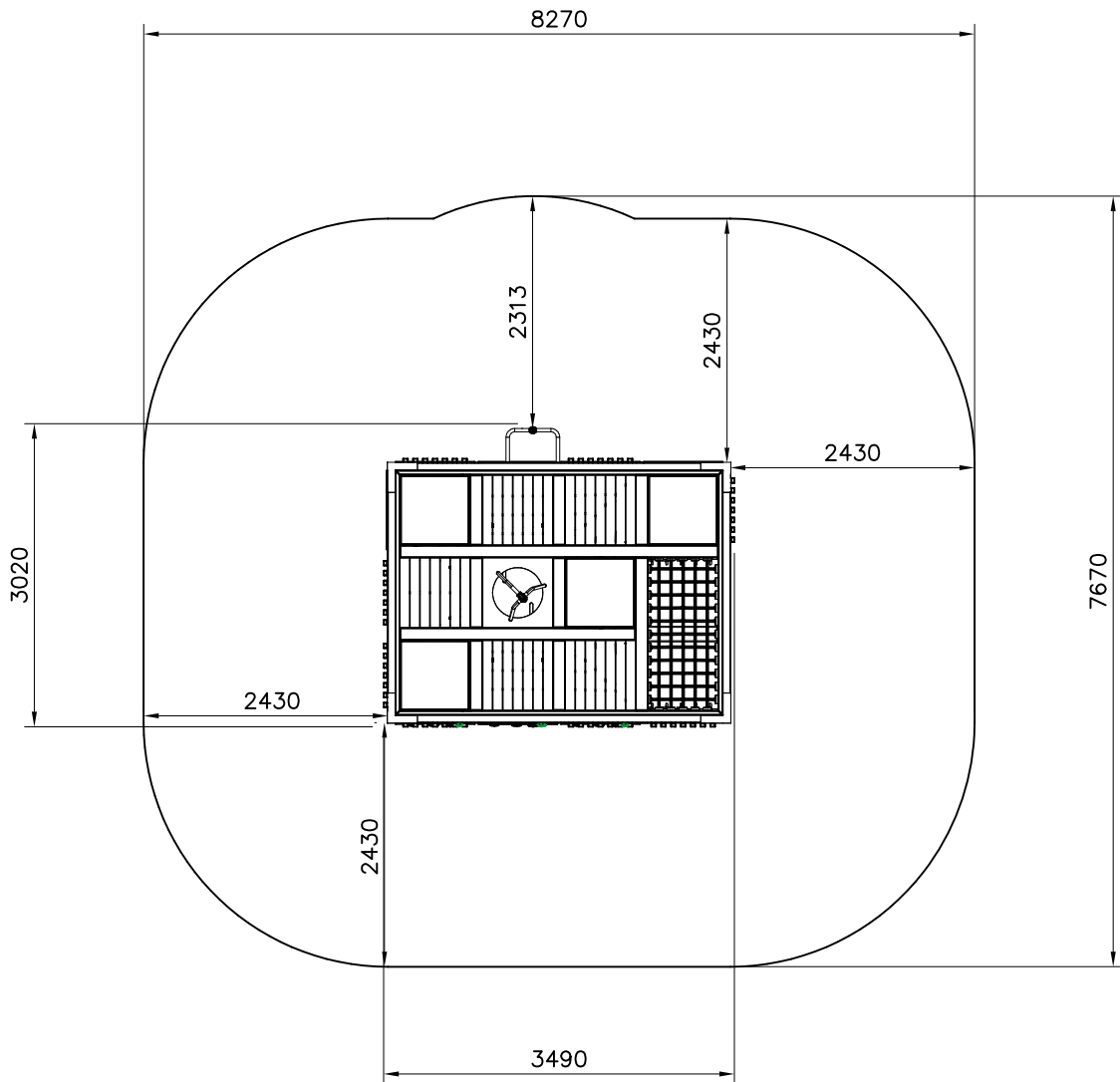
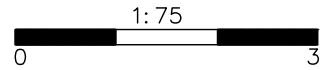

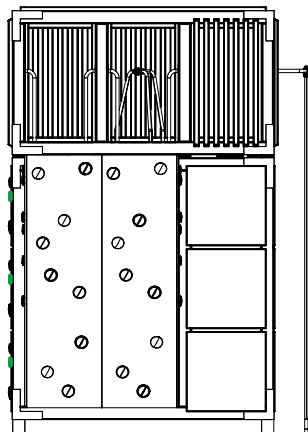
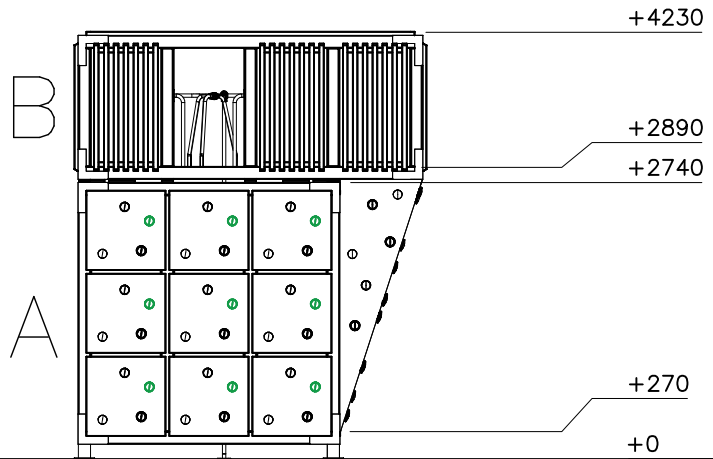

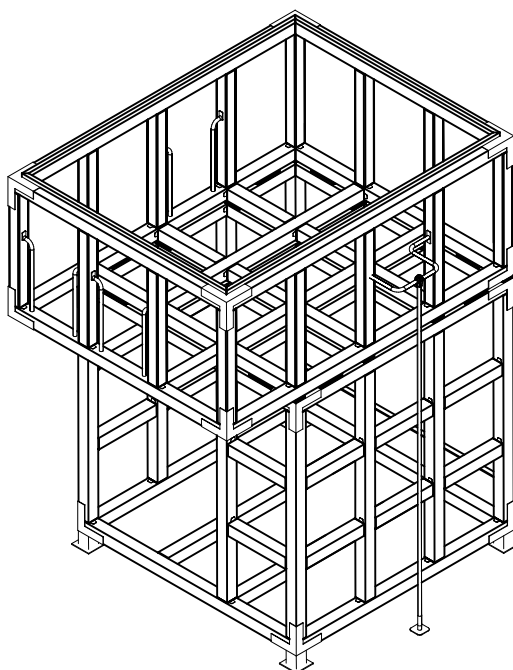
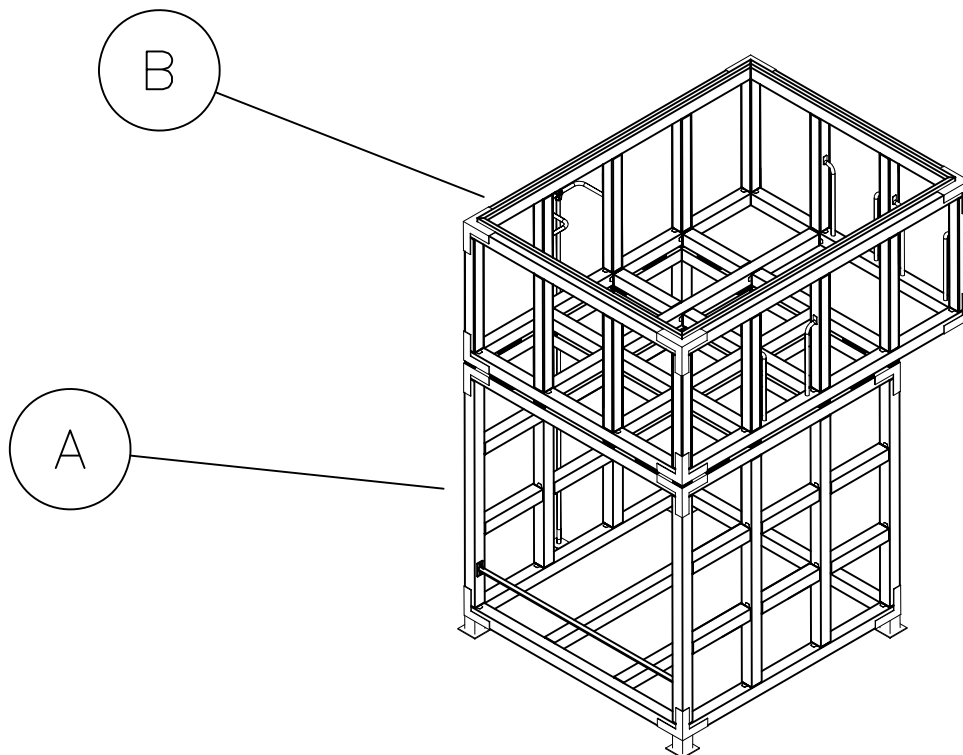

<p>DET 1</p>	<p>DET 2</p>	<p>DET 3</p>	<p>DET 4</p>
<p>DET 5</p>	<p>DET 6</p>	<p>DET 7</p>	<p>DET 8</p>
<p>DET 9</p>	<p>DET 10</p>	<p>DET 11</p>	<p>DET 12</p>
<p>DET 13</p>		<p>DET 15</p>	<p>DET 16</p>
<p>DET 17</p>	<p>DET 18</p>	<p>DET 19</p>	<p>DET 20</p>

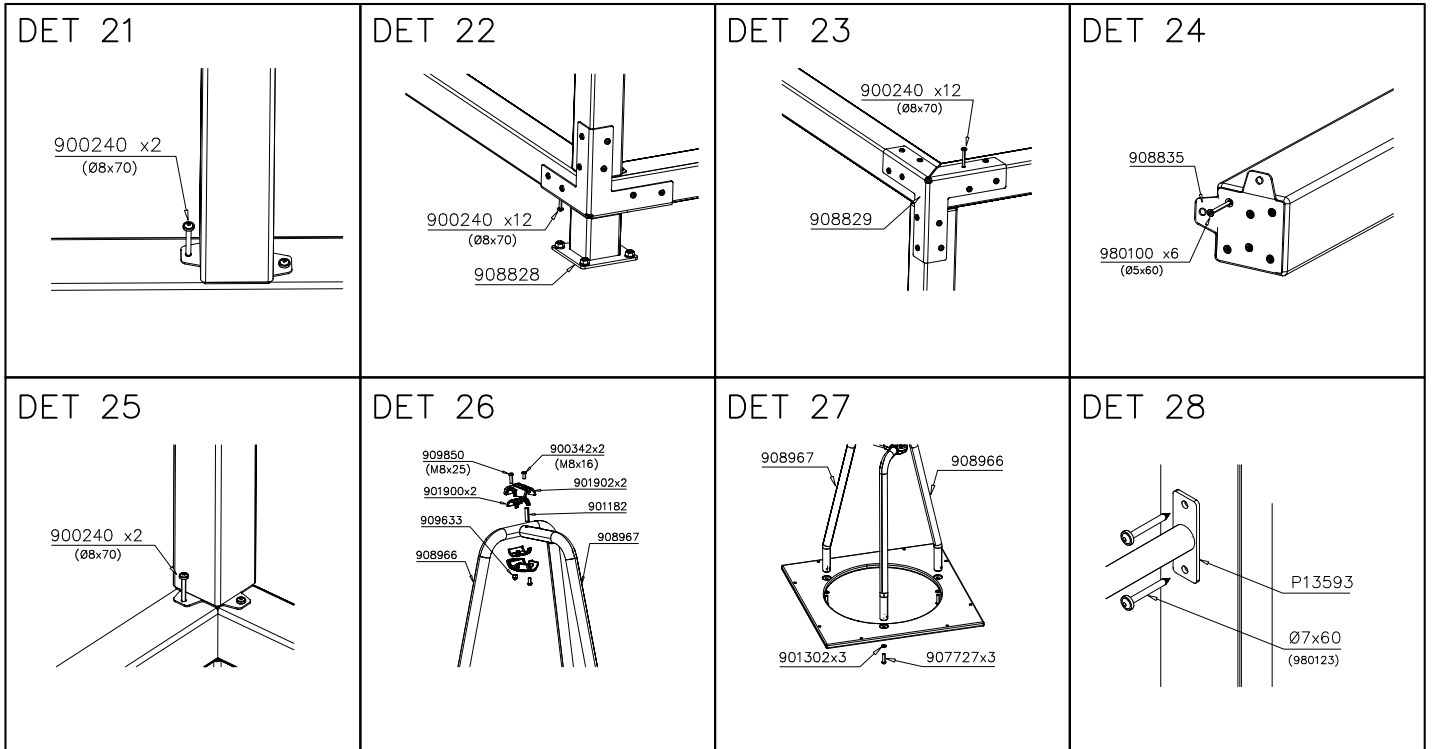

DET 29

NOTE:

Grip positions and angles are adjustable (90°, 180°, 270°).

Grip can be repositioned by removing the fastening bolt and pulling the grip off.

Securing pin can be repositioned when angle is changed.

After the parts are reassembled. Finish the assembly by fastening the cover plugs (Ø30).

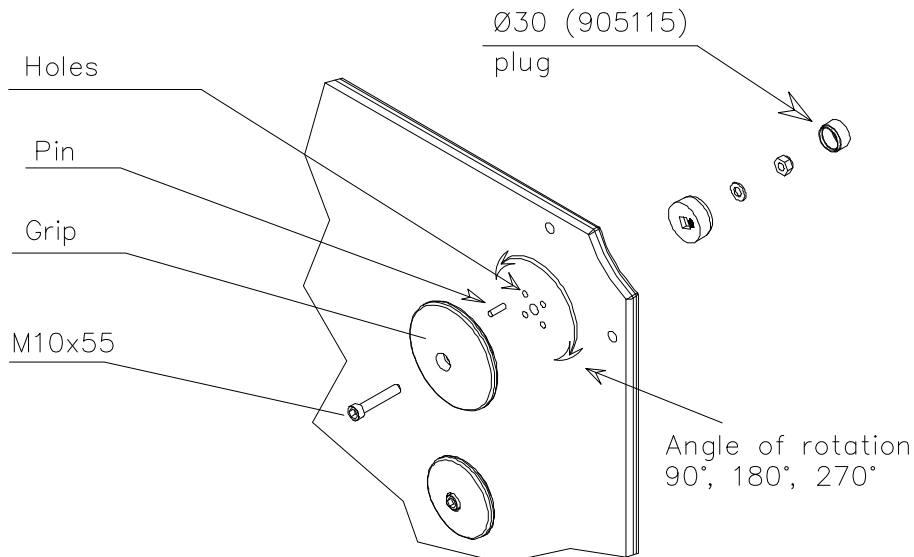

DET 30

Ø8x70
(900240)

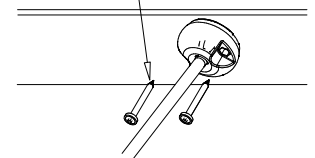

DET 31

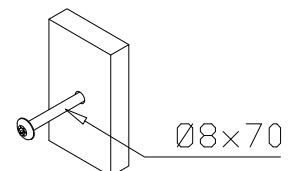

DET 14

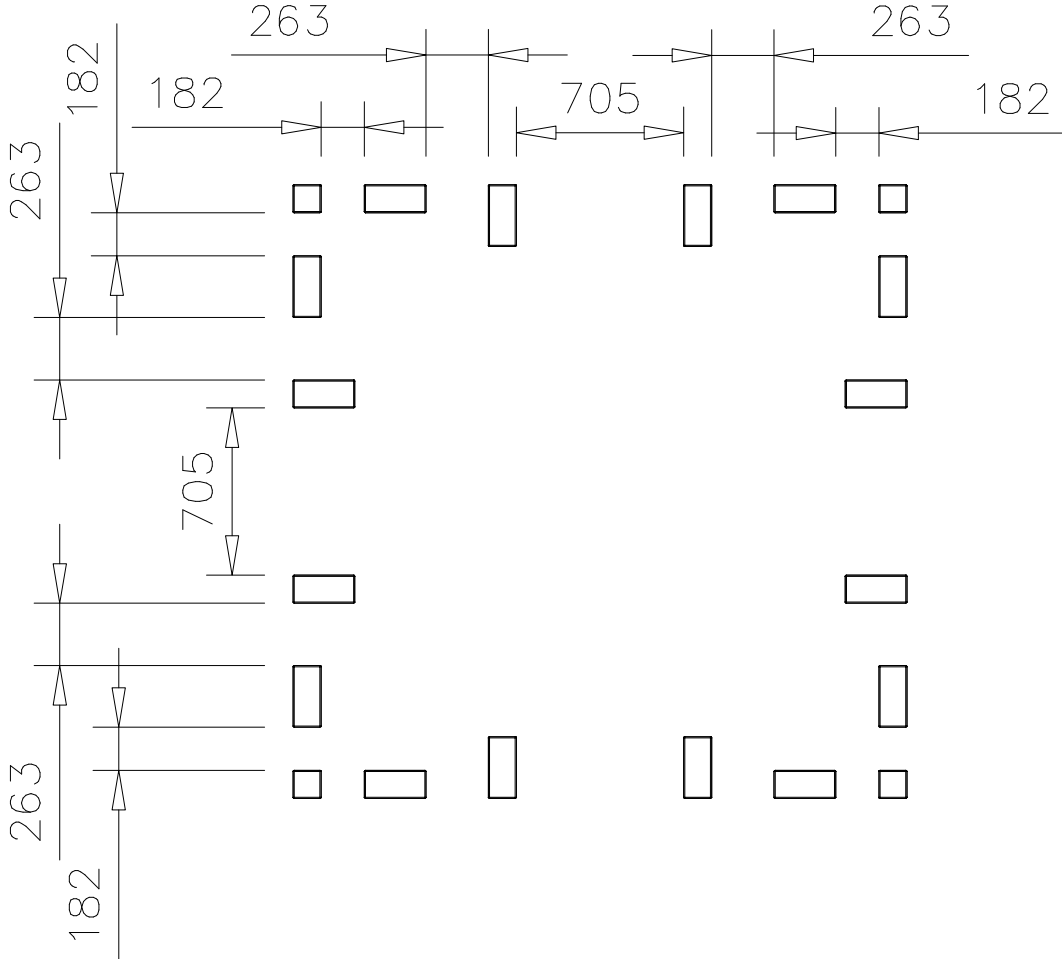

DATE: 15.11.2019

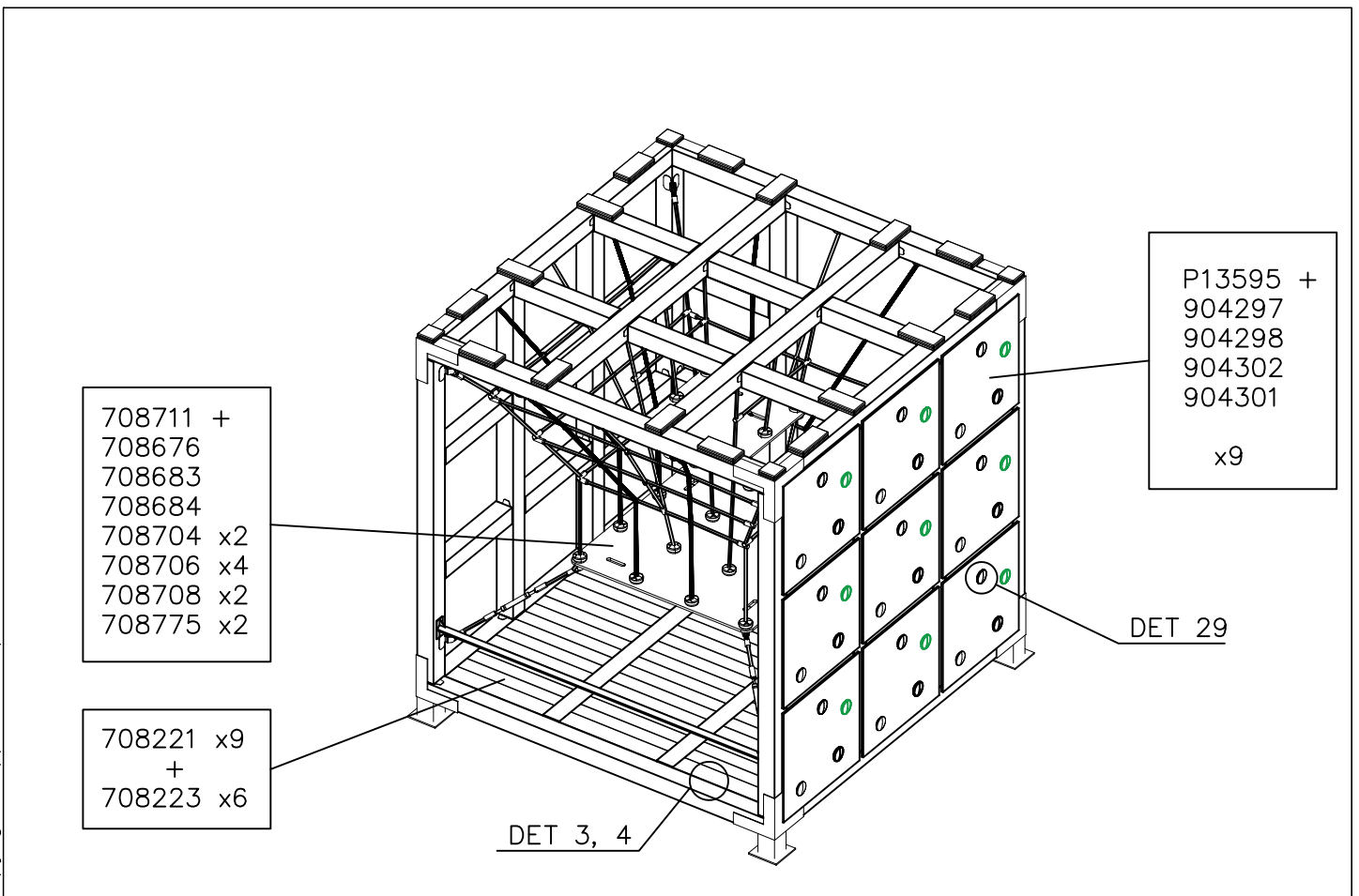
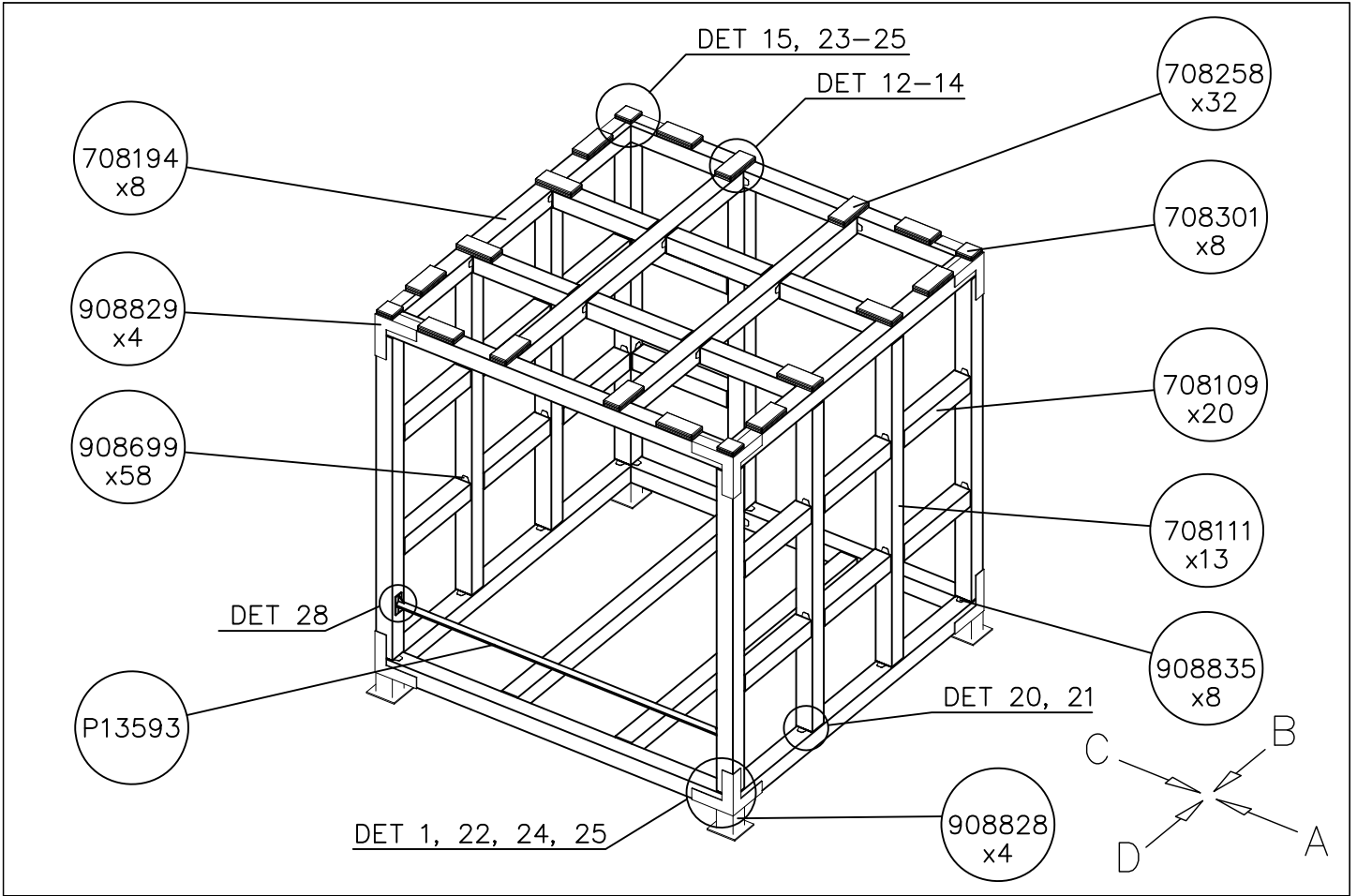

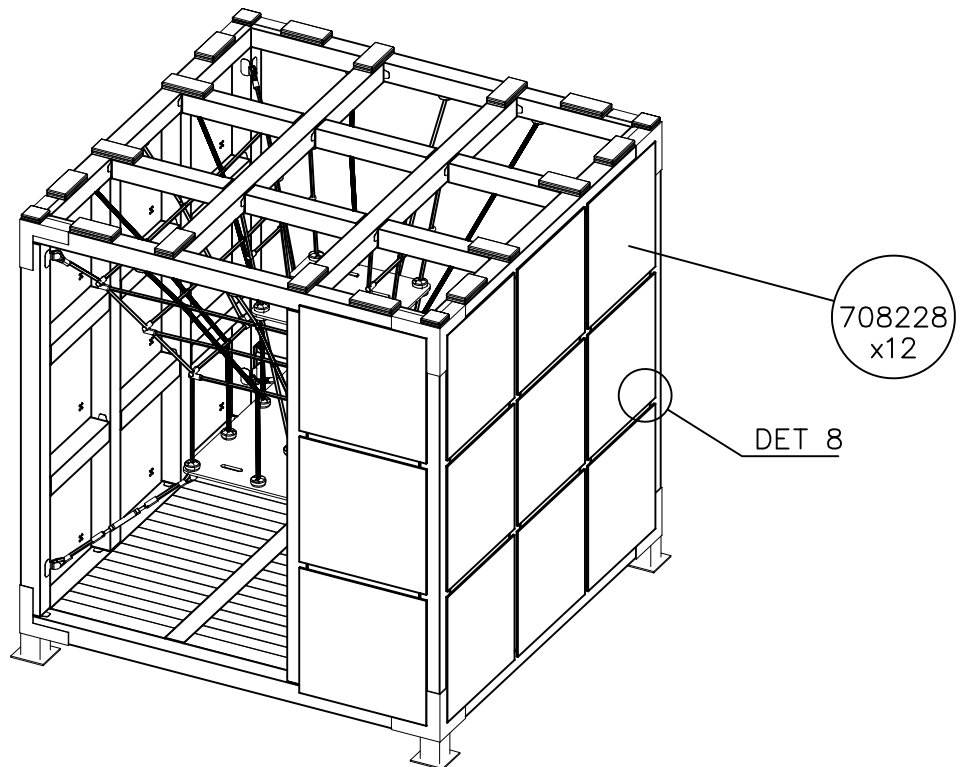
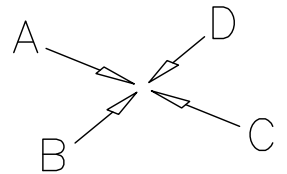
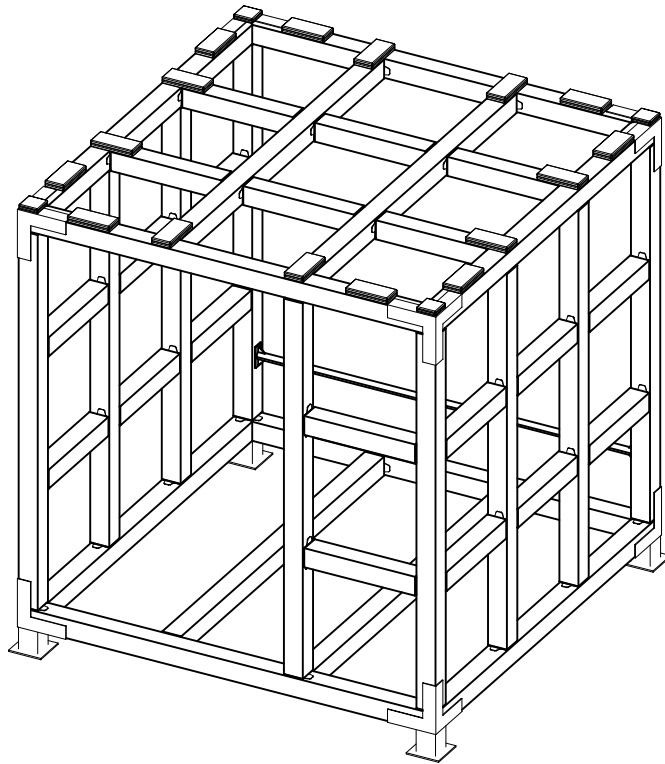

DATE: 15.11.2019

1:50

(A)

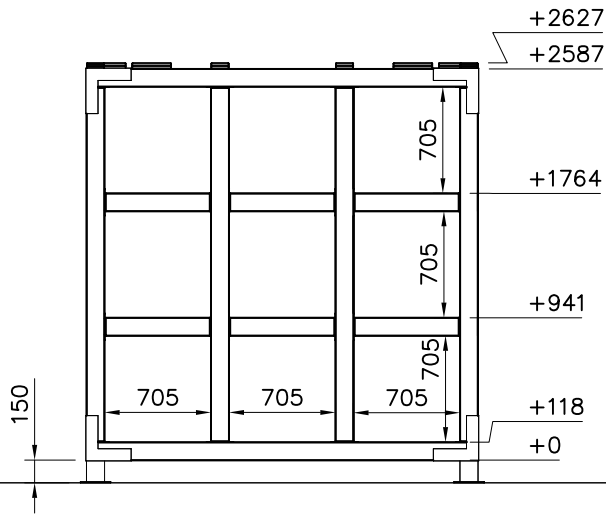

(B)

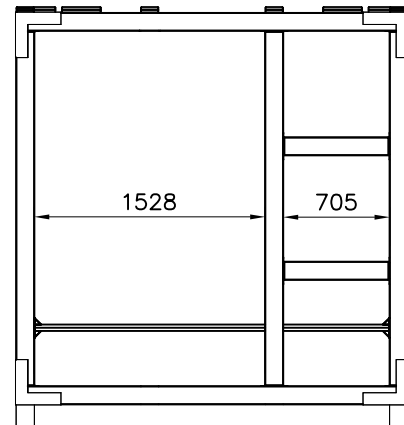

(C)

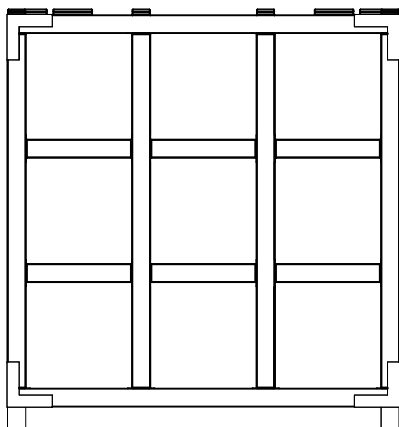

(D)

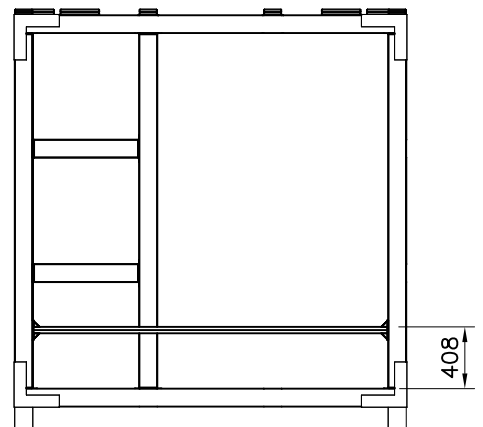

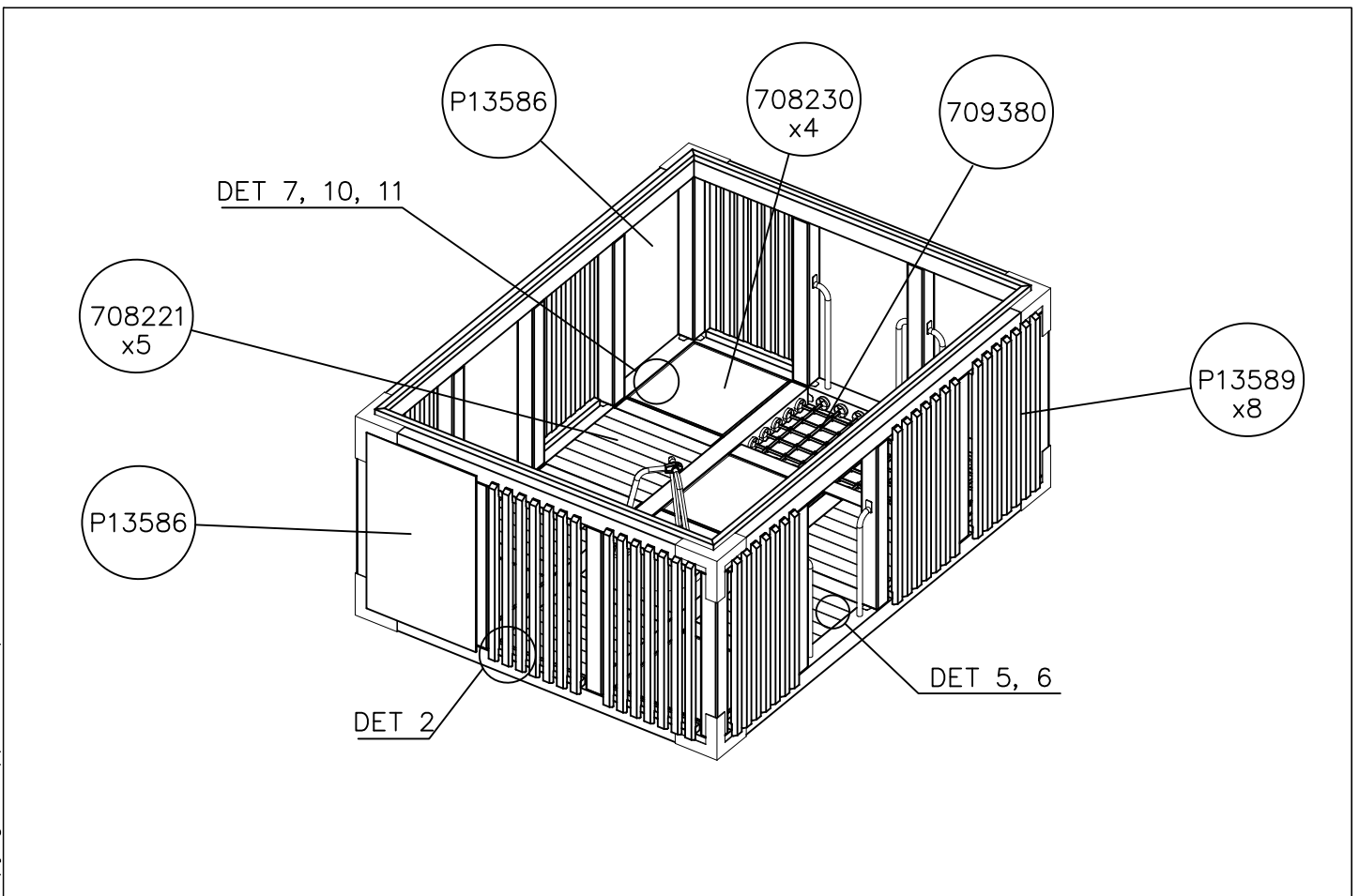
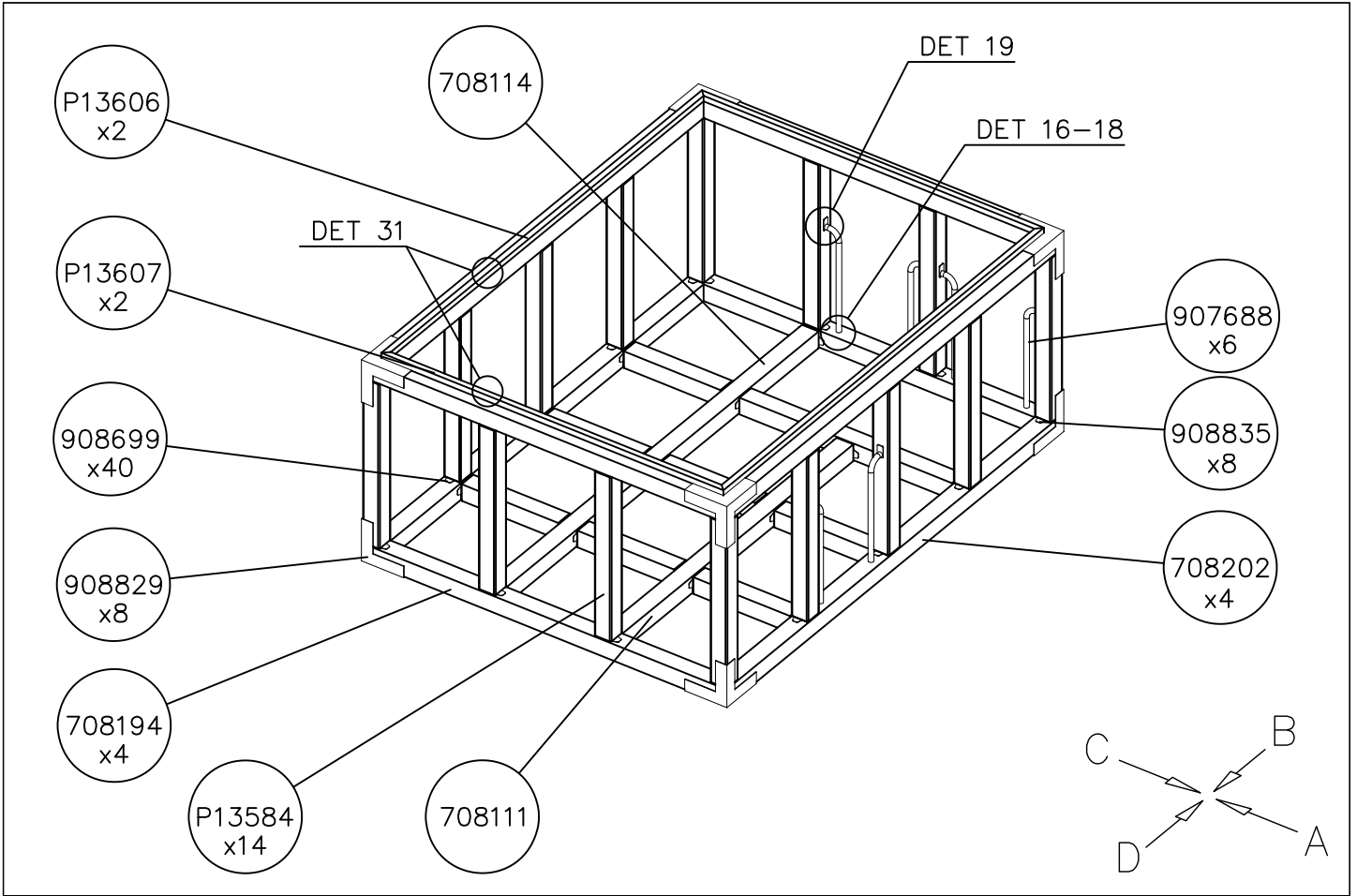

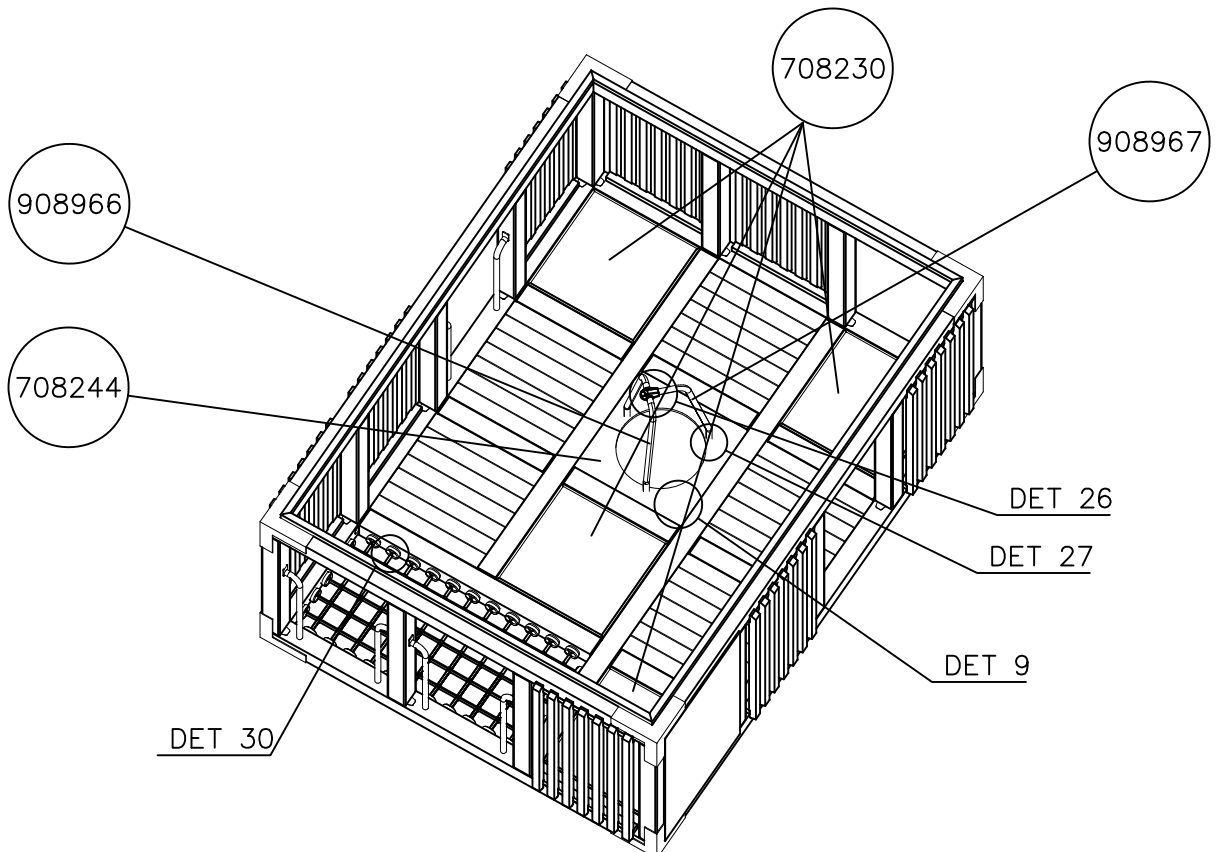
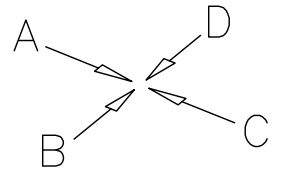
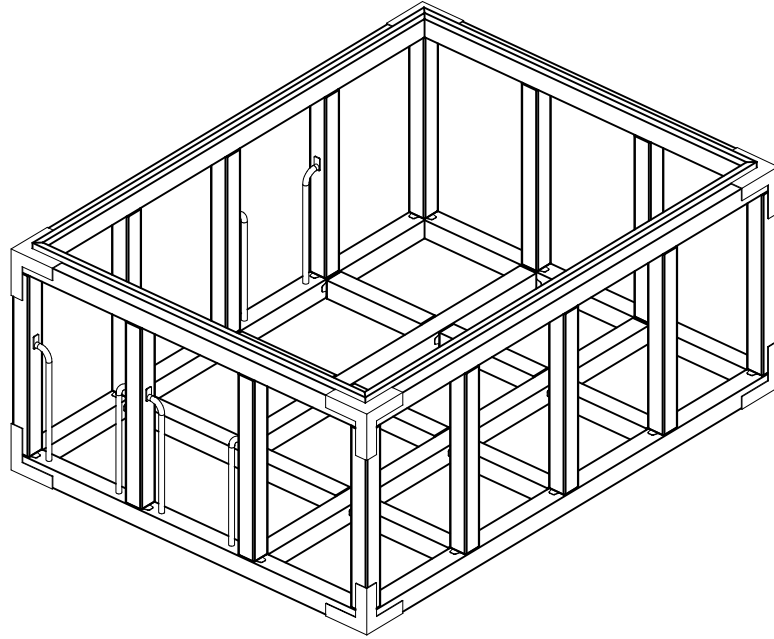

DATE: 15.11.2019

1:50

(A)

(B)

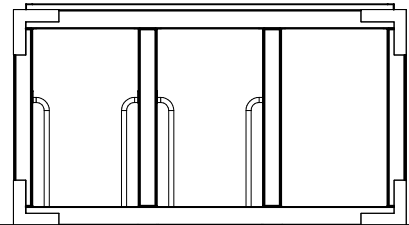
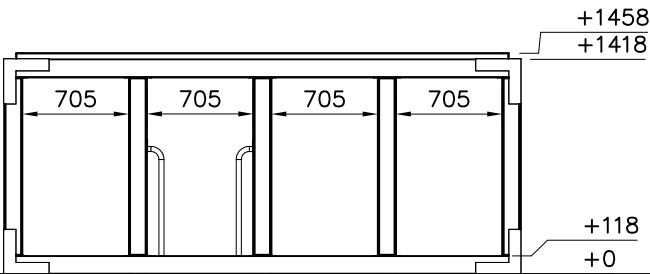

(C)

(D)

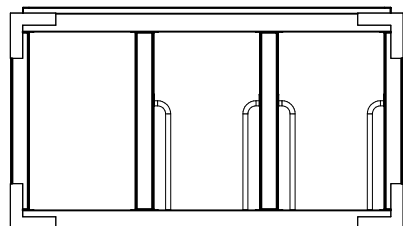
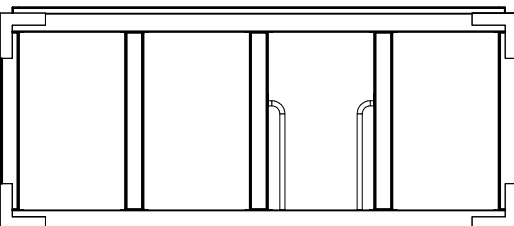

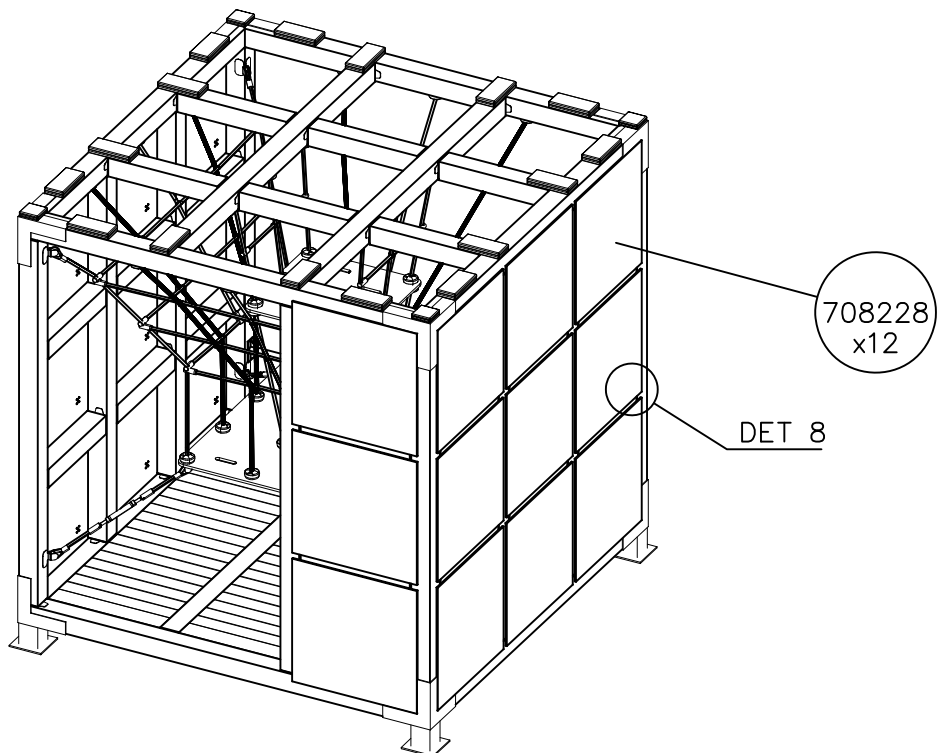
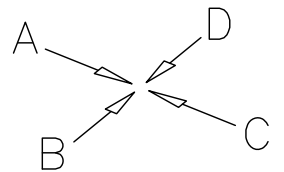
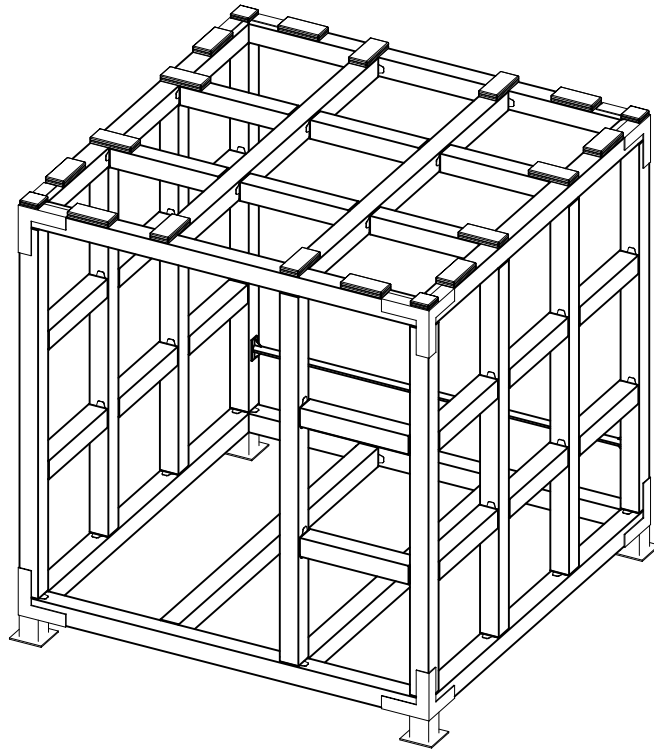

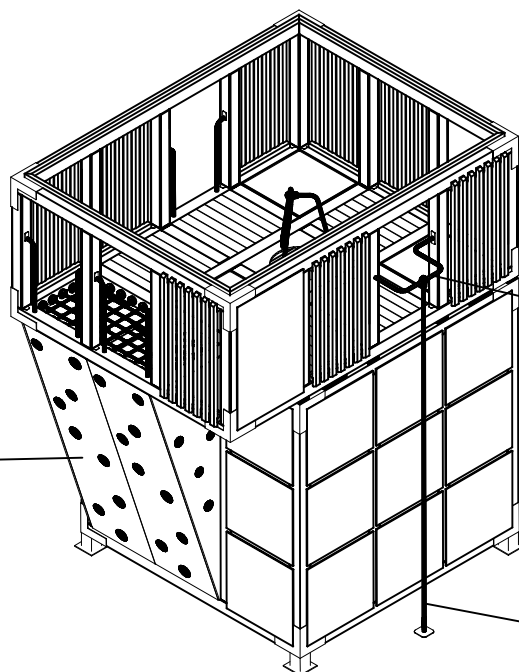
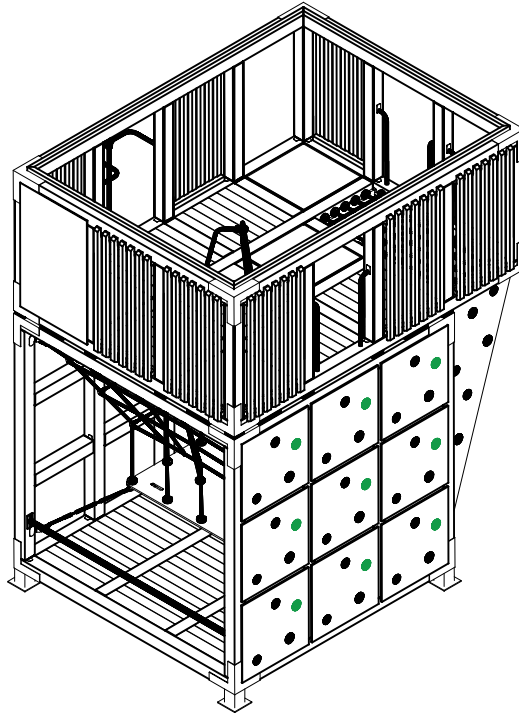

A10414

907695

910997