

LAPPSET®

SISU





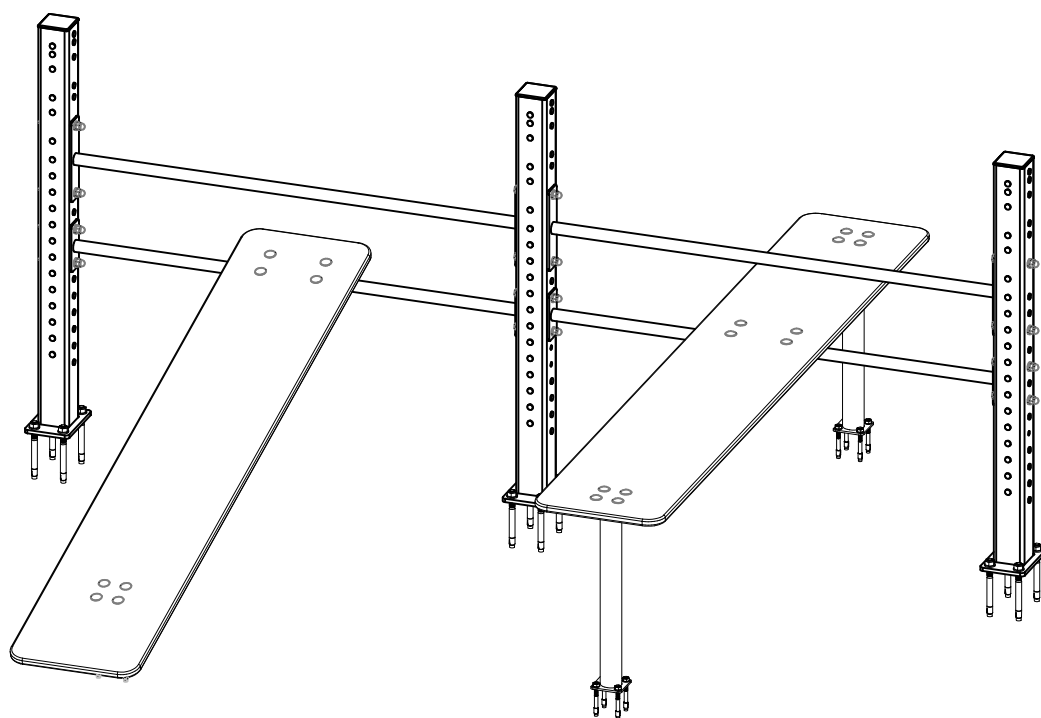

ASENNUSOHJE
MONTERINGSANSVISNING
INSTALLATION INSTRUCTION
AUFBAUANLEITUNG
NOTICE D'INSTALLATION

DATE: 7.12.2022

Q13471

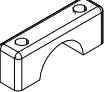
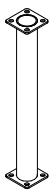

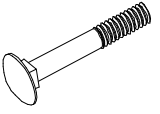
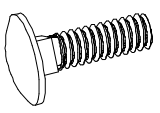
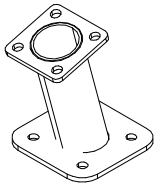
DATE: 7.12.2022

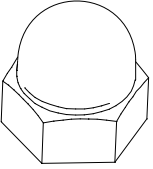
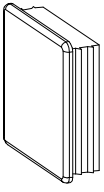
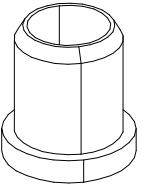
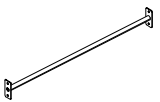
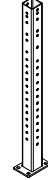
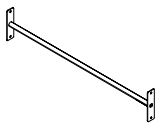
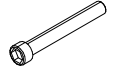
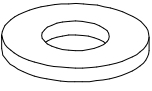
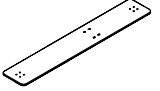
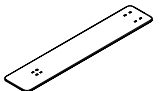
702341  90x50	PCS 1	902096  M12x120	PCS 4	902454  550	PCS 4	902564  550	PCS 2	904450  M16x170	PCS 12	909107  M12x80	PCS 8
909109  M12x40	PCS 12	909514  130x130x174	PCS 1	909628  M10x100	PCS 12	909644  M12	PCS 32	910405  90x90x30	PCS 3	910415  Ø16/12,5-14x17	PCS 192
910622-217  1315	PCS 2	910655-207  90x90x1200	PCS 3	911016-217  1315x240	PCS 2	912127  M12x110	PCS 8	980154  Ø24/13	PCS 60	P01986  P01986	PCS 1
P01987 	PCS 1		PCS		PCS		PCS		PCS		PCS
	PCS		PCS		PCS		PCS		PCS		PCS
	PCS		PCS		PCS		PCS		PCS		PCS
	PCS		PCS		PCS		PCS		PCS		PCS

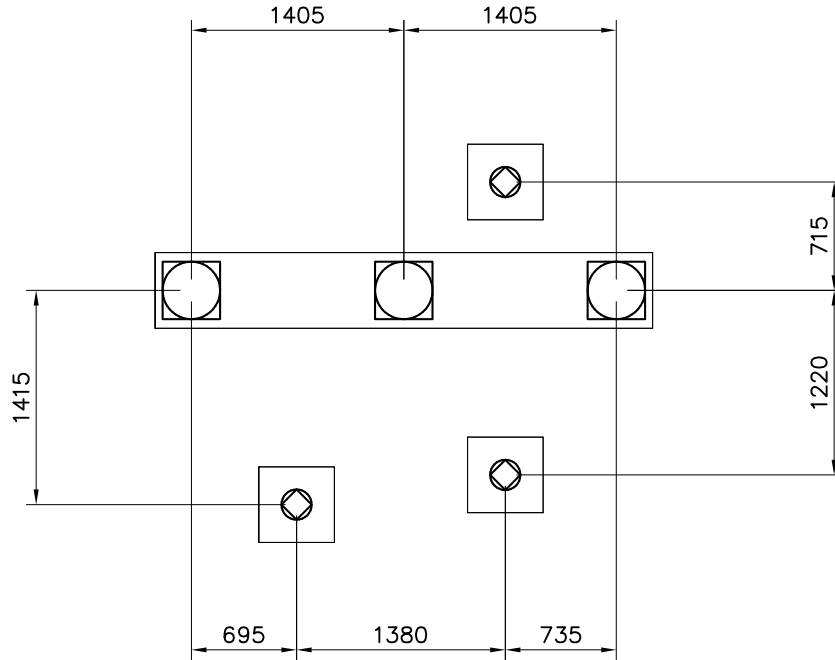
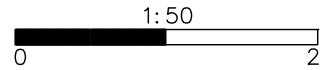

Concrete foundation plans

1pcs 500x3290x200

3pcs 500x500x200

= 0,479 m³

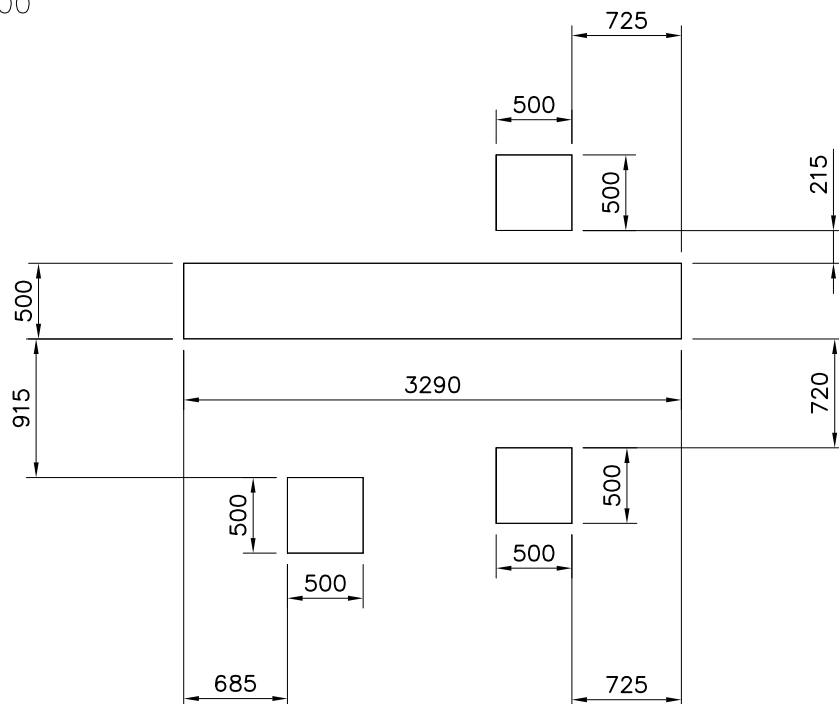

<p>Ø16 ↓ > 130</p> <p>85</p> <p>145</p>	<p>120Nm</p> <p>M16x170</p> <p>h > 150</p> <p>Concrete / Betoni K30</p>	<p>Pre-drill hole Ø10 ↓ 90 (x4)</p> <p>90</p> <p>90</p>
<p>35 Nm</p> <p>M10x100</p> <p>90</p> <p>S</p> <p>M10x100</p>		

- Area of Movement 16.3 m² Max Falling Height 1210 mm
- Movement Space 24.8 m²
- Training Space 10.5 m²

