

LAPPSET®

FINNO







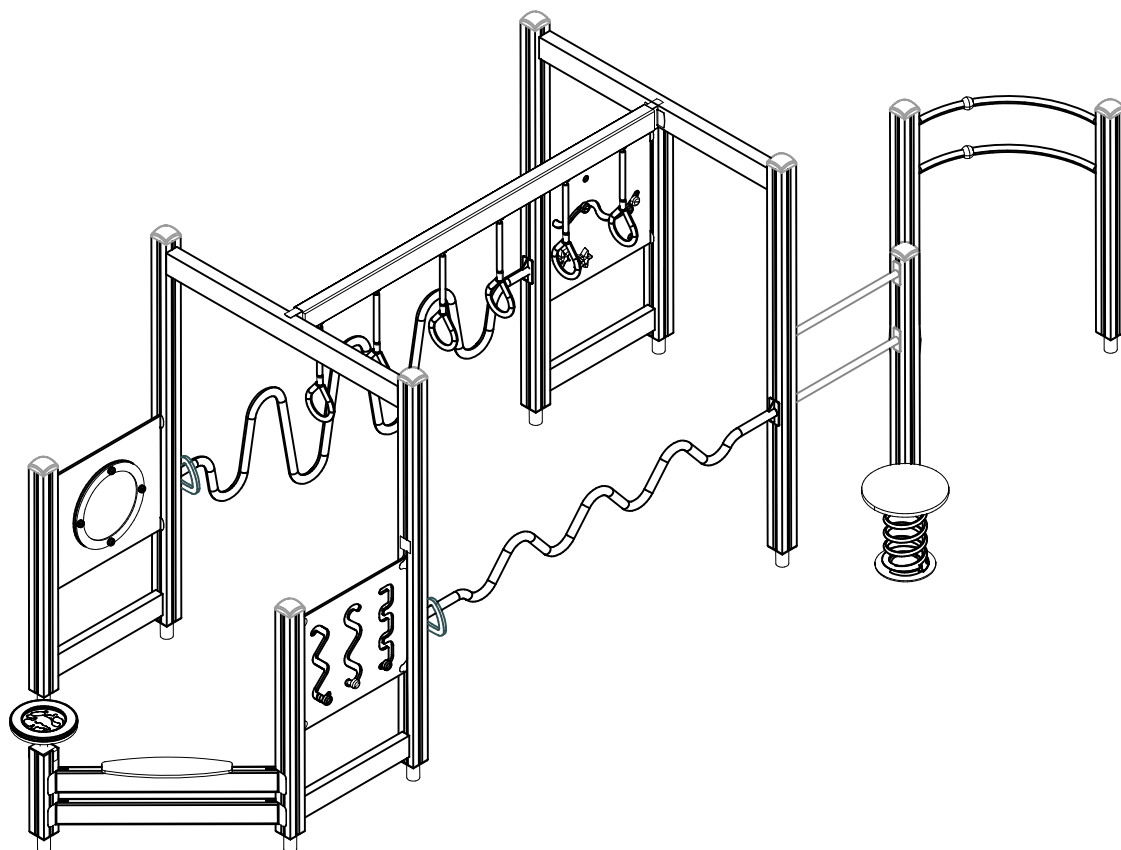



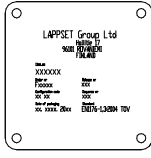
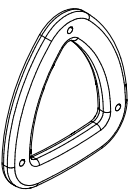
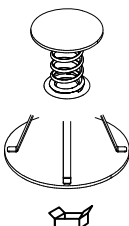

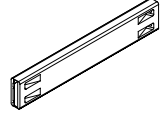
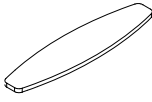
ASENNUSOHJE
MONTERINGSANSVISNING
INSTALLATION INSTRUCTION
AUFBAUANLEITUNG
NOTICE D'INSTALLATION

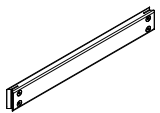
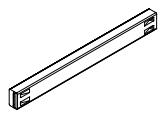
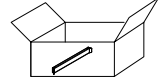
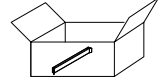
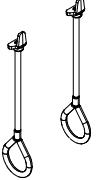
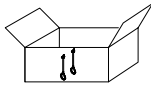
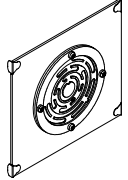
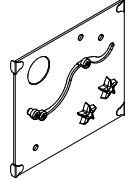
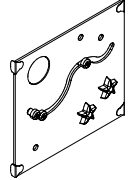
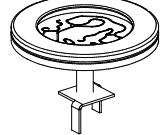
DATE: 30.4.2021

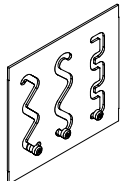
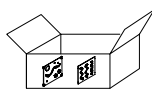
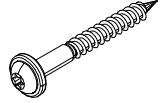
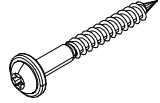
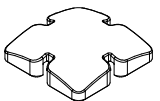
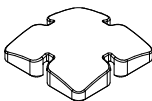
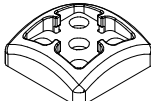
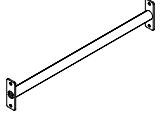
Q12420-2

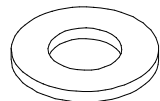

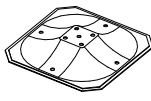
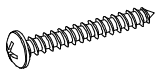
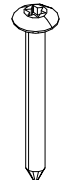
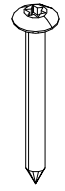
DATE: 30.4.2021

701401-602	PCS 6	702286	PCS 1	705369-704	PCS 2	705423	PCS 1	705505-217	PCS 2	706439-602	PCS 3
											
L 1250		65x65								L 704	
706453	PCS 2	706484-602	PCS 4	706510-602	PCS 4	706514-602	PCS 2	706531	PCS 11	706538	PCS 4
											
15x145x600		93x93x2150		45x120x1030		70x120x1504					
706735-305	PCS 3	706742	PCS 3	706766-702	PCS 1	706778	PCS 1	707209-702	PCS 1	707305-703	PCS 1
											
								10x640x702			
707331-602	PCS 1	707386-702	PCS 1	707450	PCS 2	707585	PCS 1	900240	PCS 8	903093	PCS 20
											
93x93x470		10x640x702				FASTENER KIT		Ø8x70		Ø8x90	
905138	PCS 10	905196	PCS 10	907694-216	PCS 2	908255-217	PCS 1	908257-217	PCS 1	909256	PCS 44
											
GRAY		GRAY		L 704		2304x222x60		2304x660x60		Ø16/8.4x1.6	
909511	PCS 11	909519	PCS 11	980114	PCS 4	980123	PCS 40	980128	PCS 12	980131	PCS 40
											
90x90x650		50x380x380		Ø4x20		Ø7x60		Ø7x40		Ø6x60	
P10478	PCS 1		PCS		PCS		PCS	PCS	PCS	PCS	
											
70x120x2280											

—— EN/AS Impact Area 37.5 m²
- - - - Falling Space 40.5 m²
Max Falling Height 0000 mm

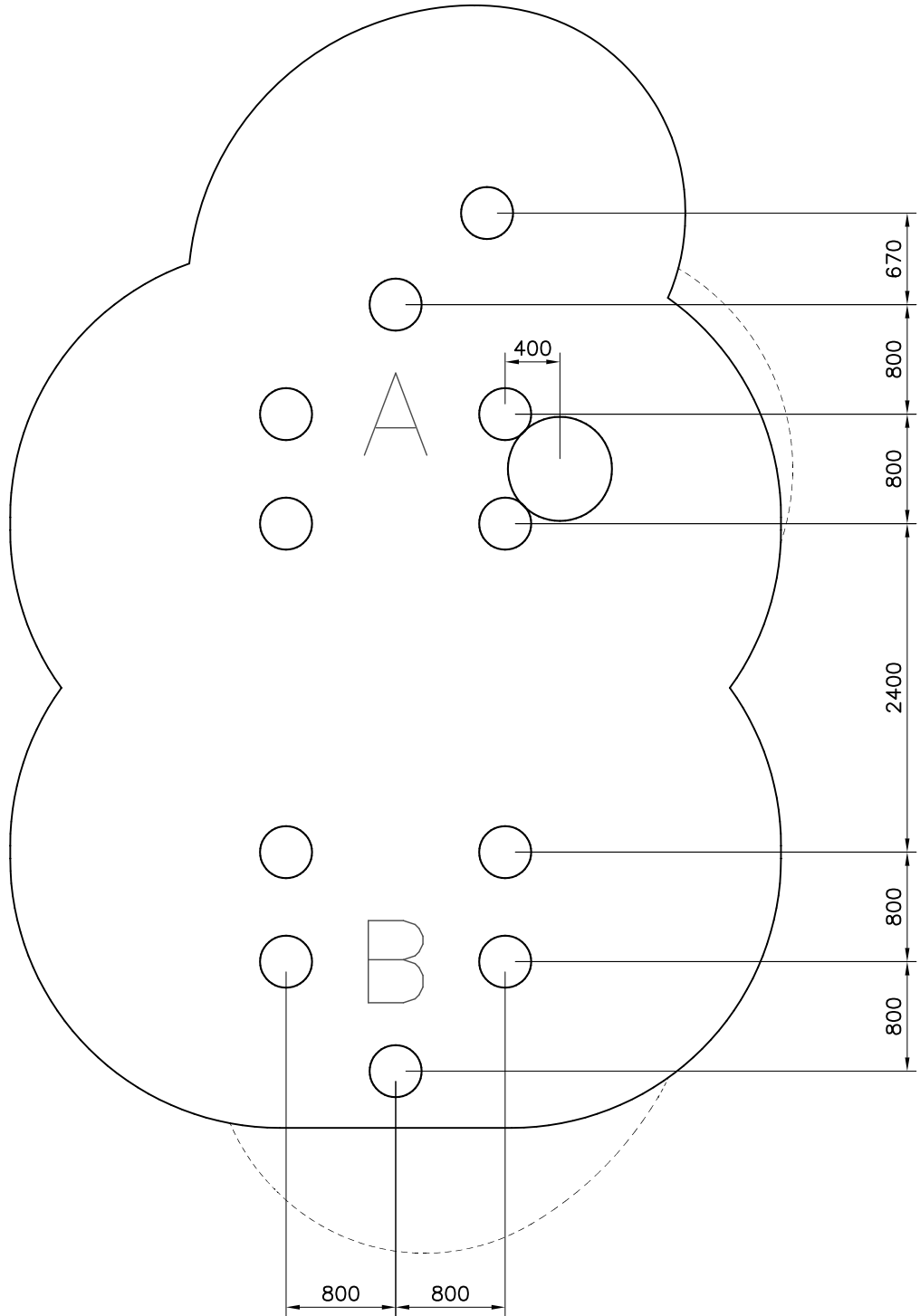

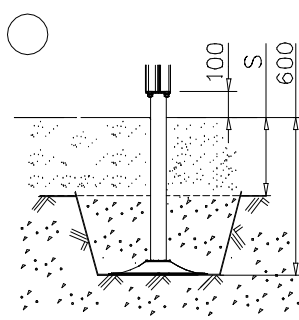
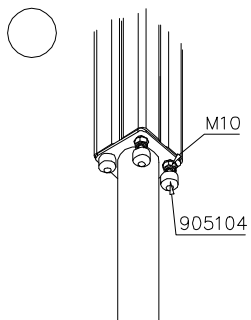

- EN/AS Impact Area 37.5 m²
- - - Falling Space 40.5 m²
- Max Falling Height 520 mm

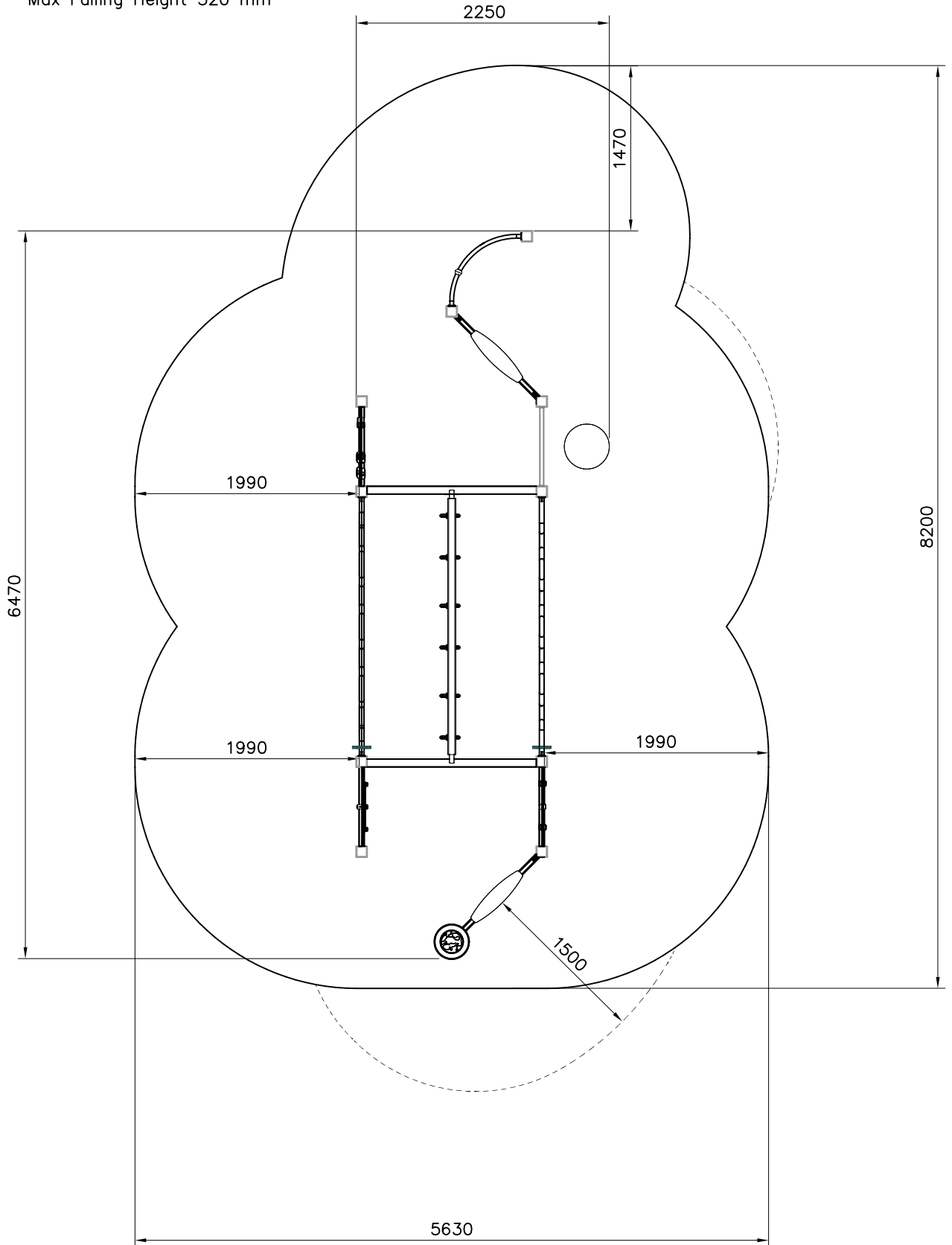

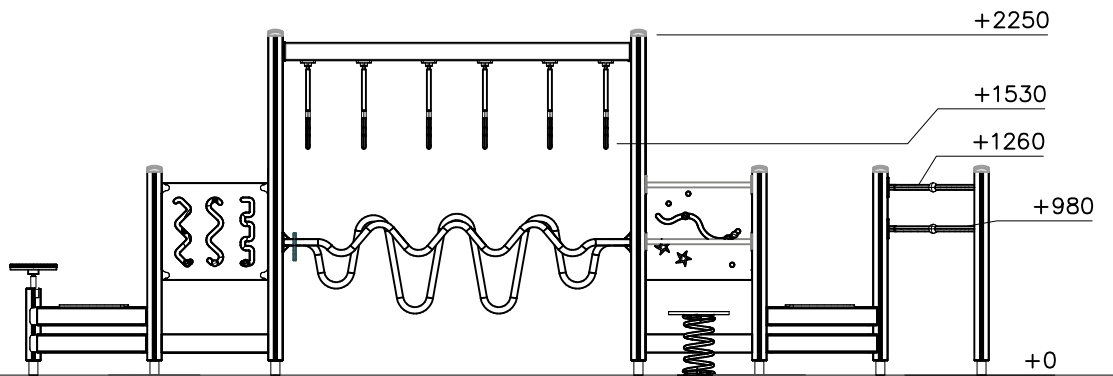
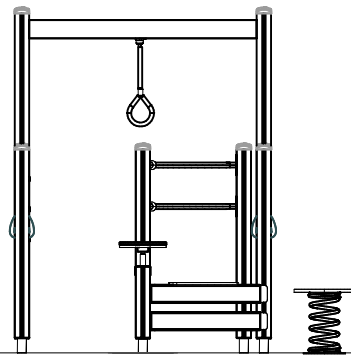

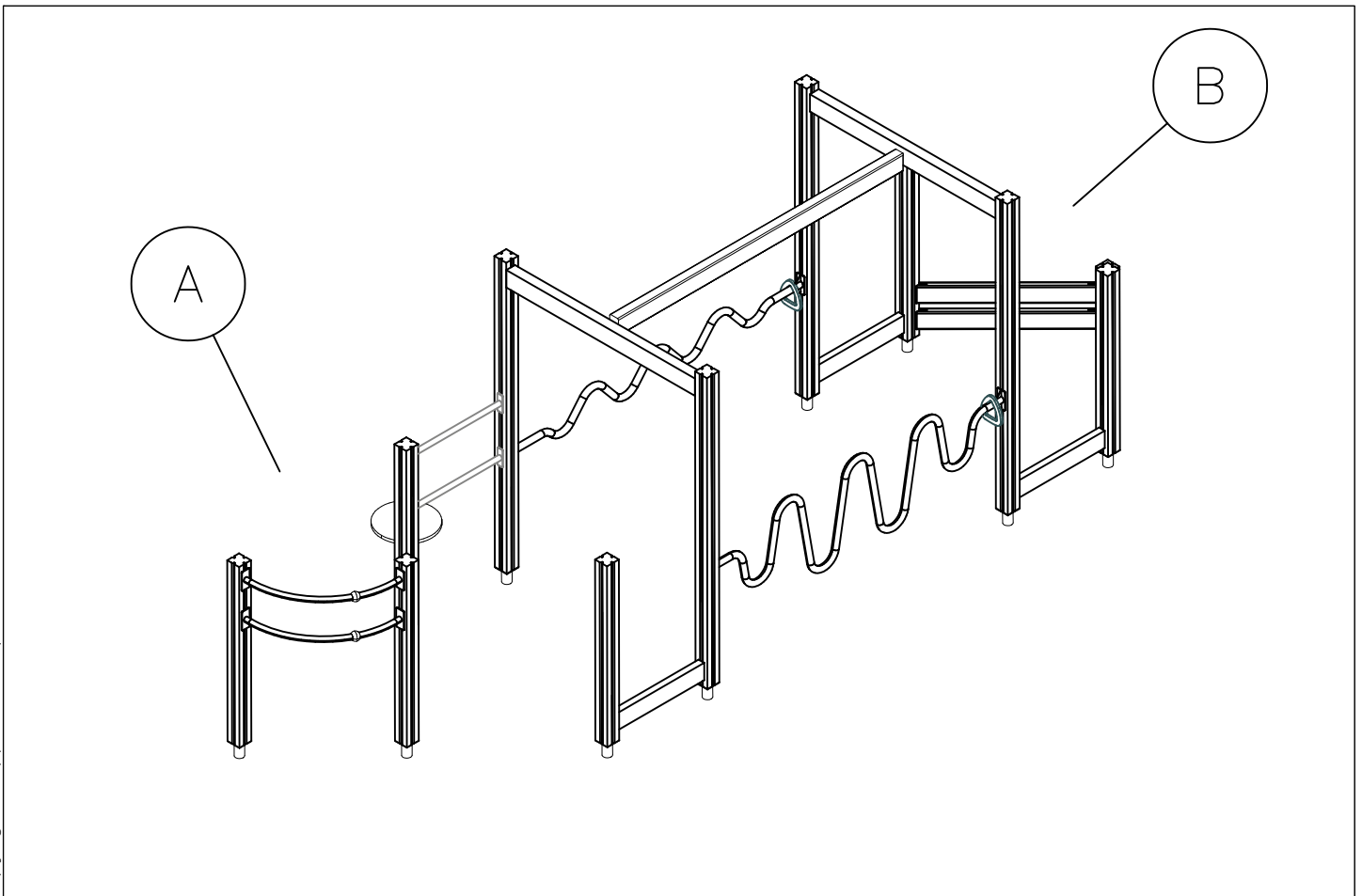
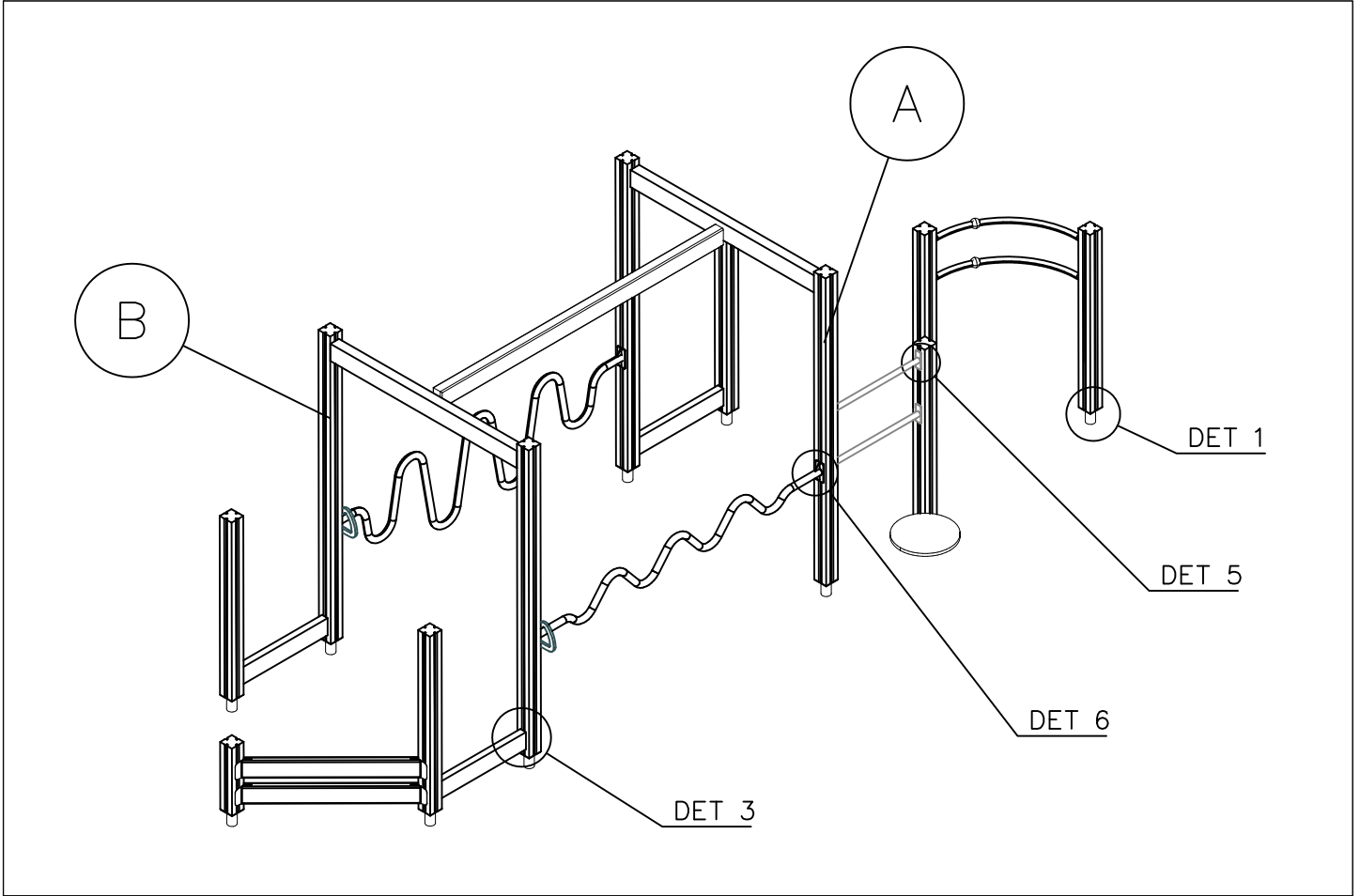

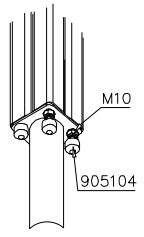
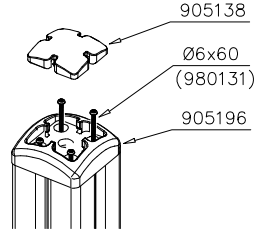
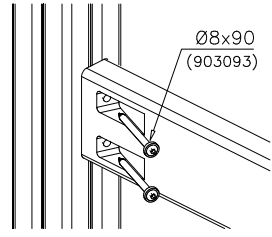
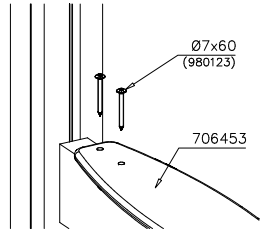
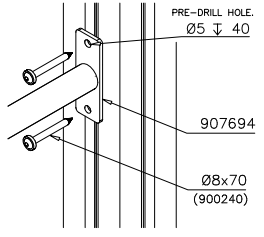
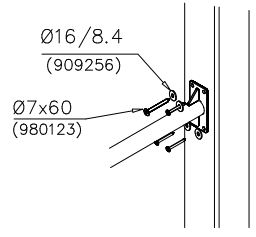
<p>DET 1</p> 	<p>DET 2</p> 	<p>DET 3</p> 	<p>DET 4</p> 
<p>DET 5</p> 	<p>DET 6</p> 		

DATE: 30.4.2021

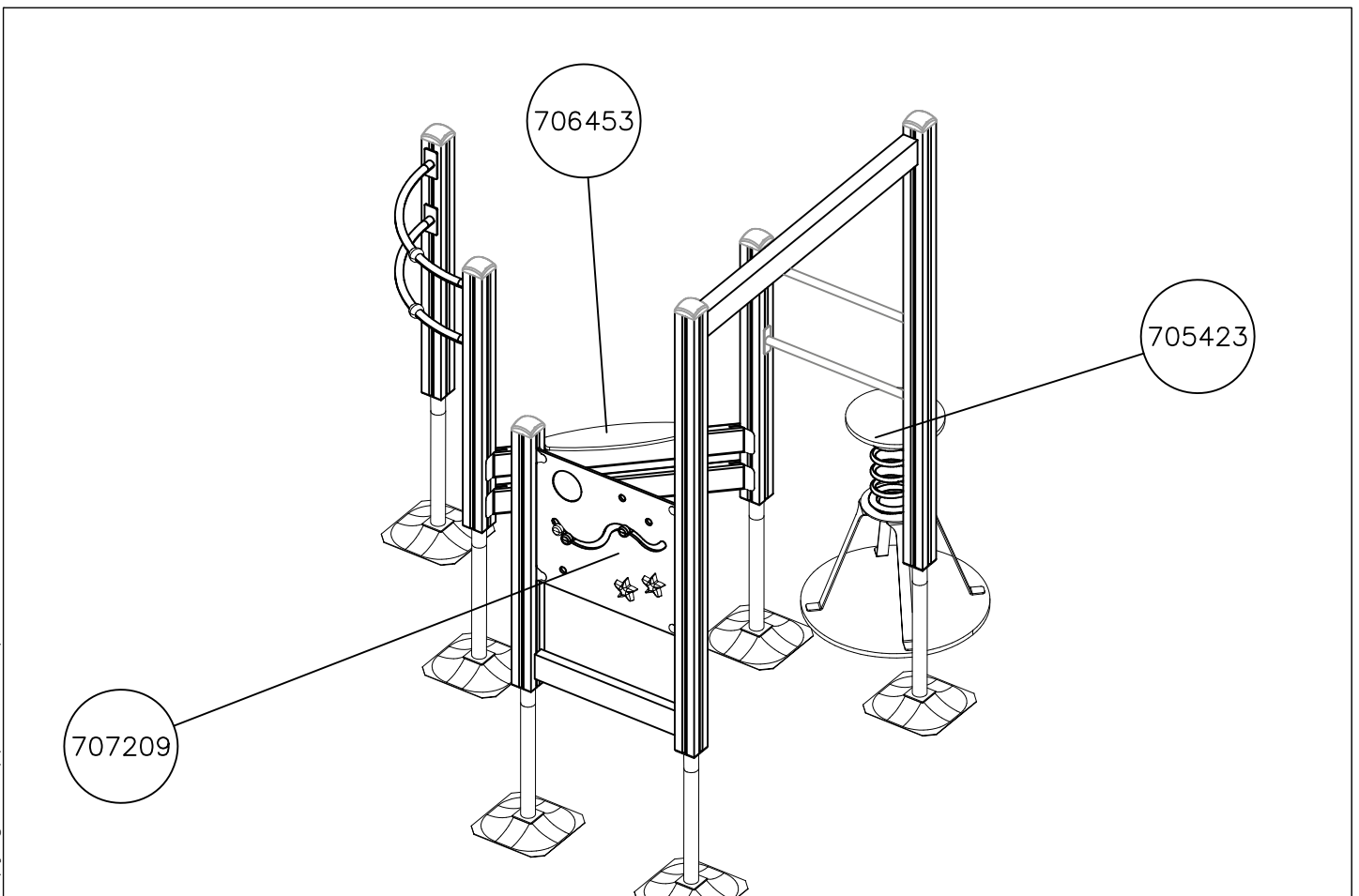
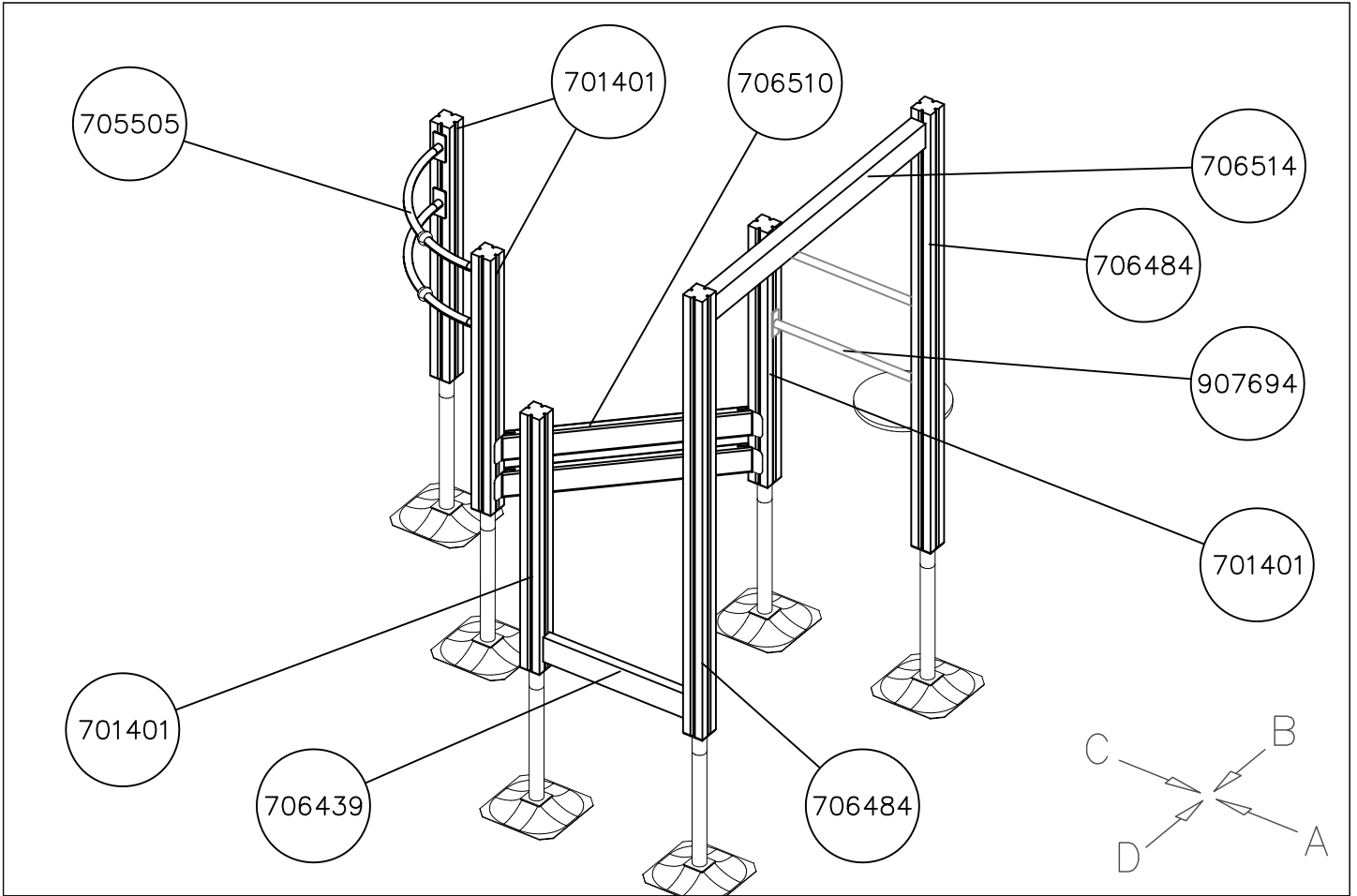

DATE: 30.4.2021

1:50

A

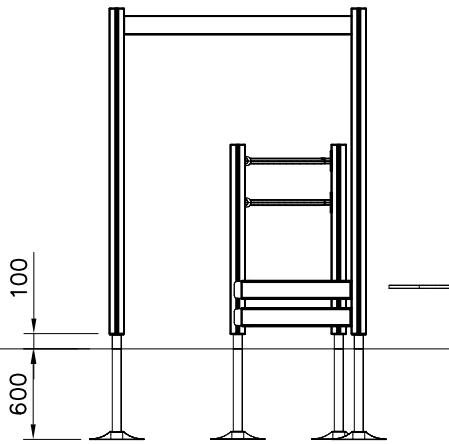

B

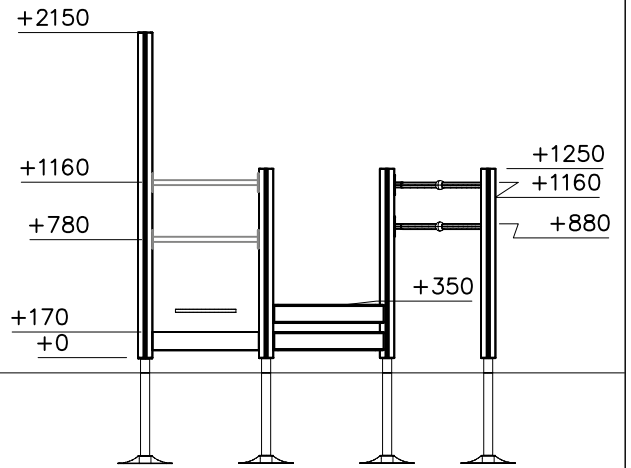

C

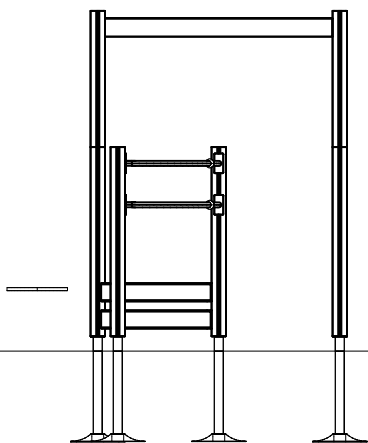

D

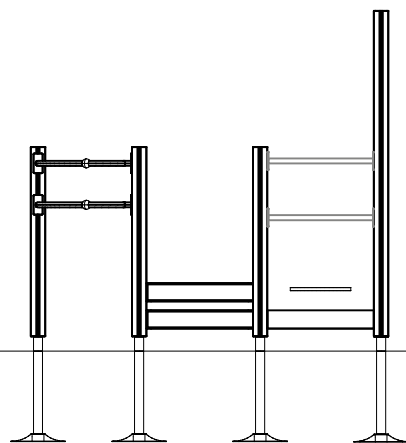

DATE: 30.4.2021

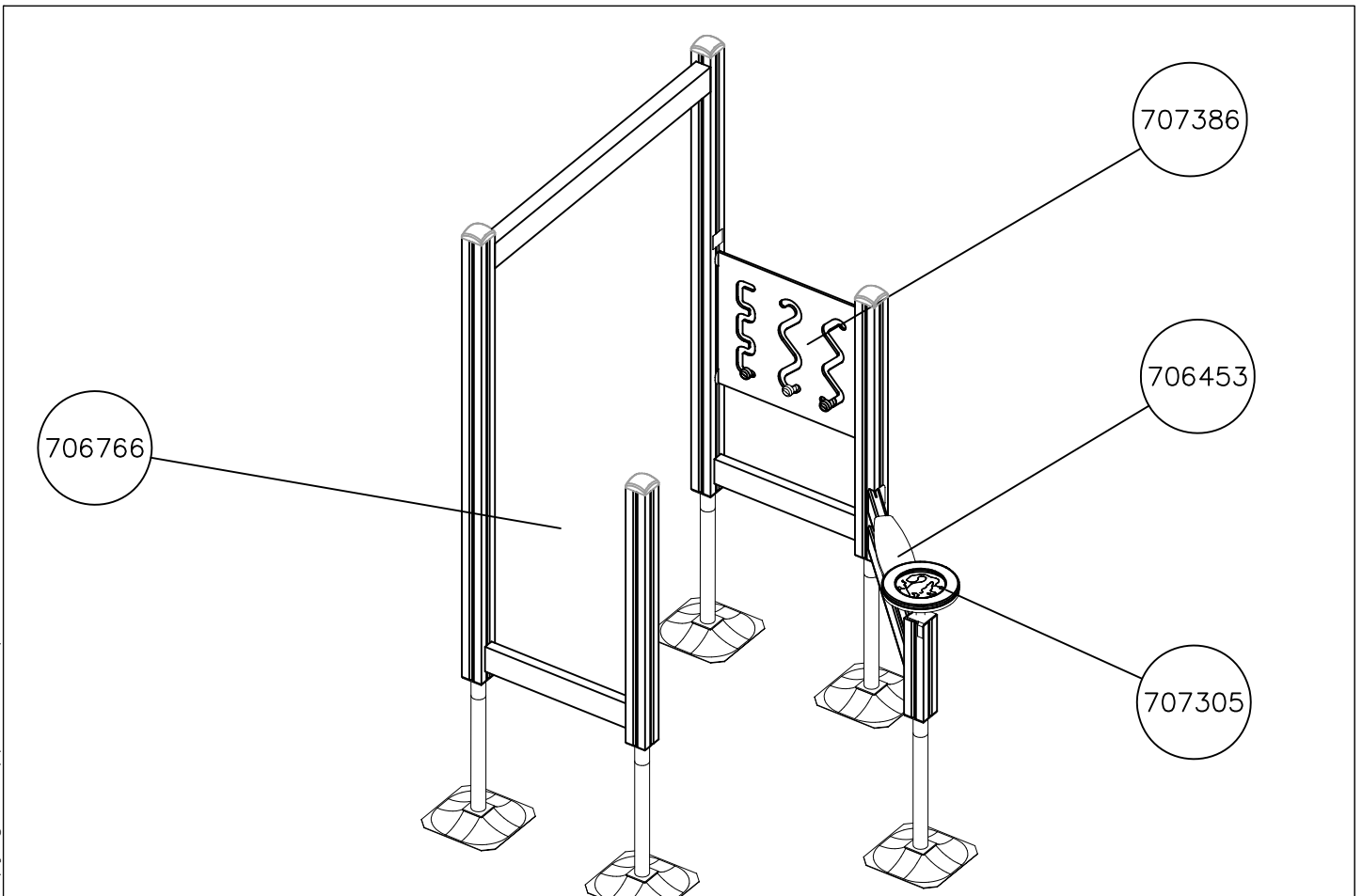
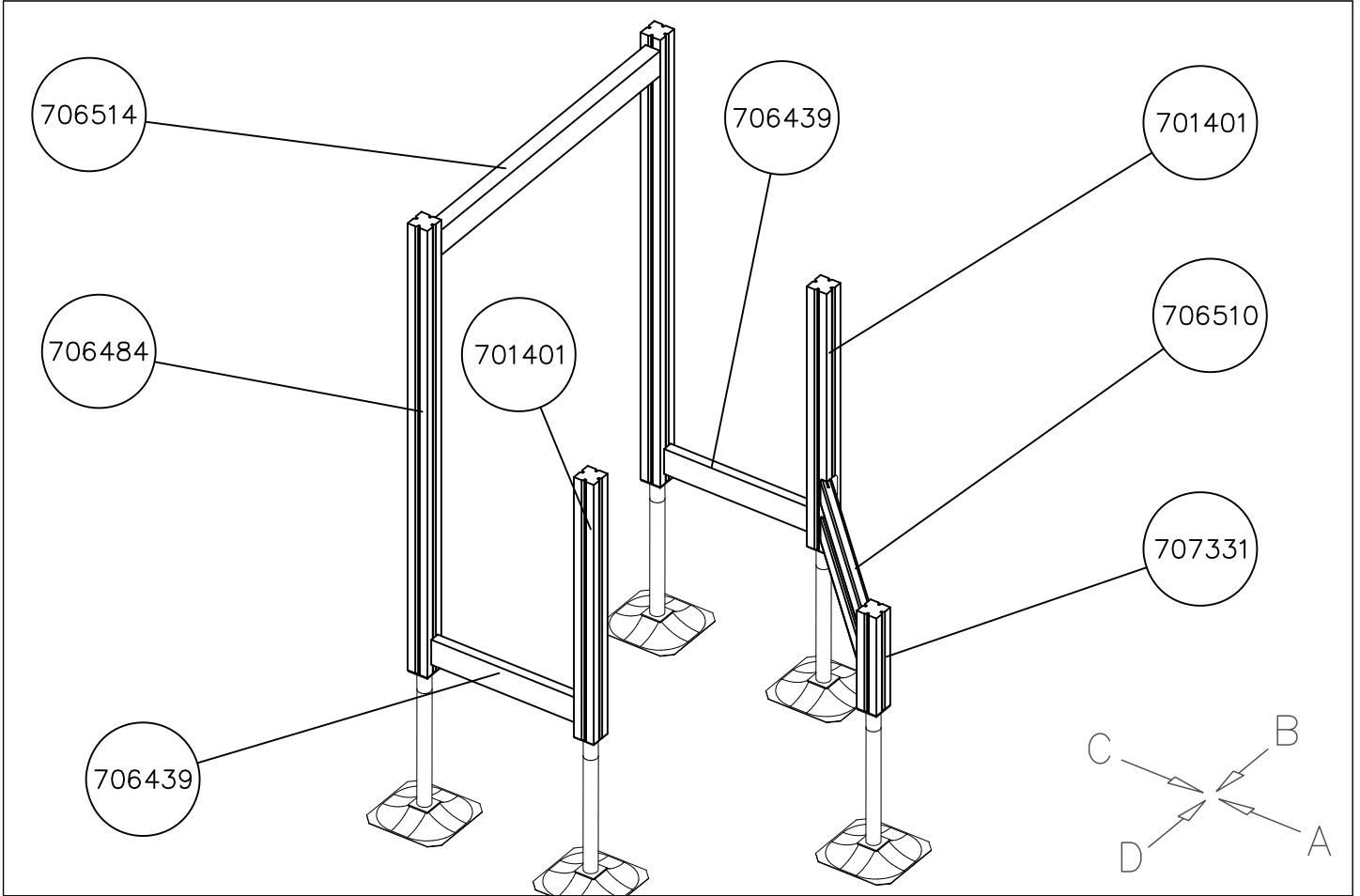

DATE: 30.4.2021

1:50

A

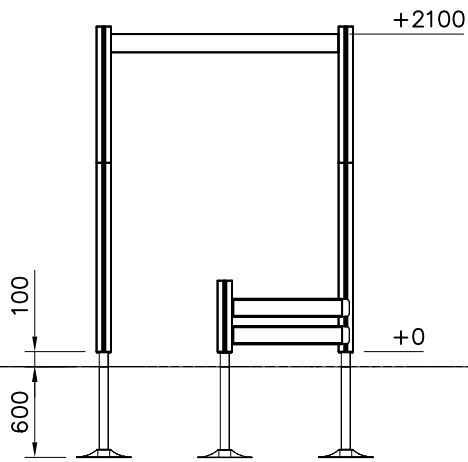

B

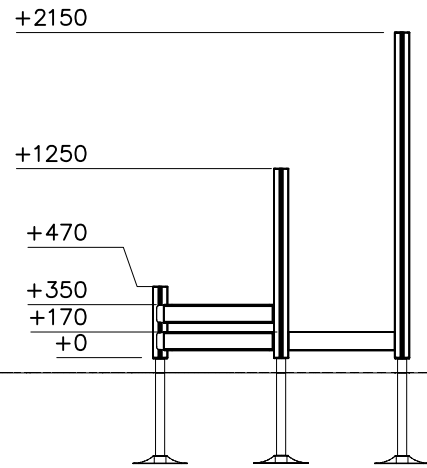

C

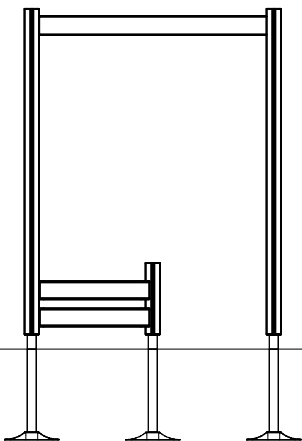

D

