

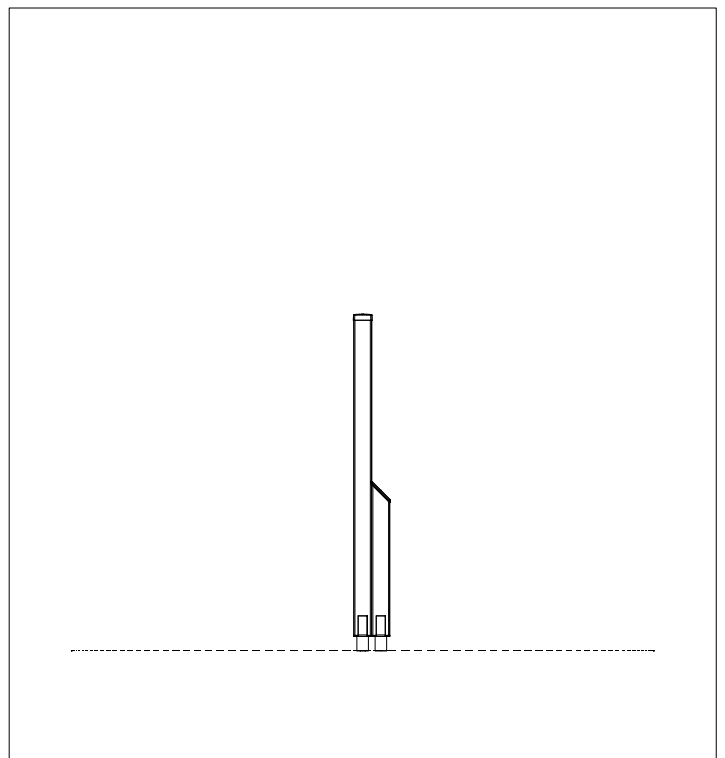

- EN/AS Impact Area 15.6 m²
- - - Falling Space 15.6 m²
Max Falling Height 2110 mm

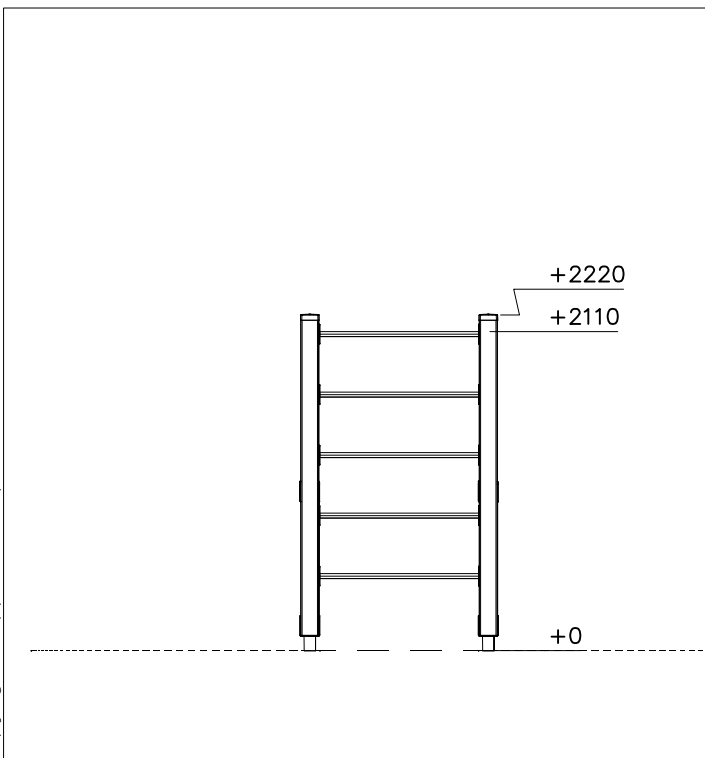
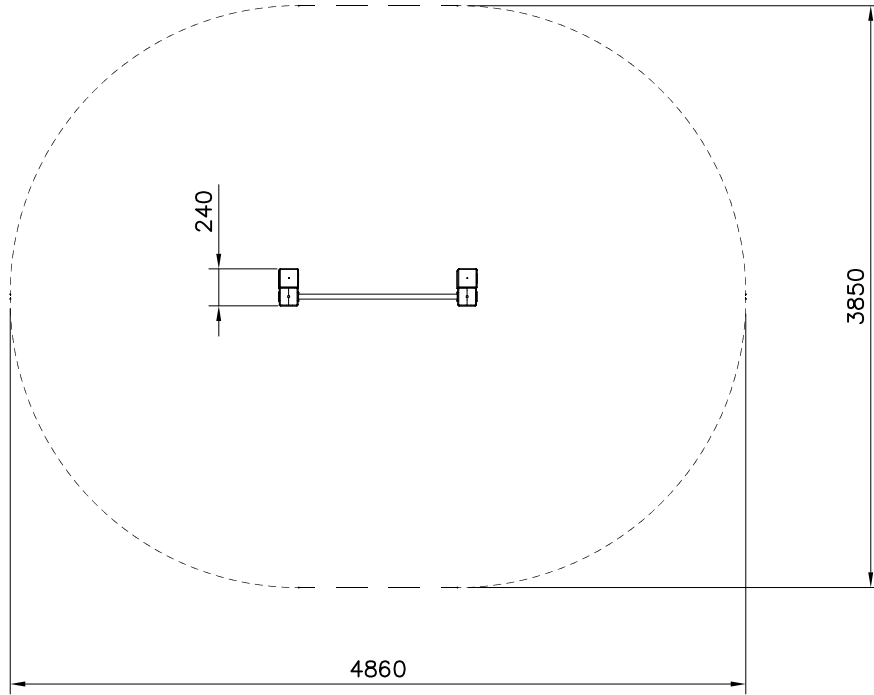
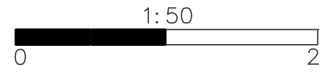
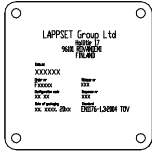
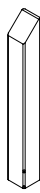
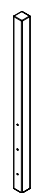
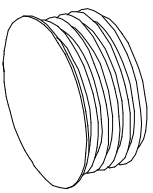
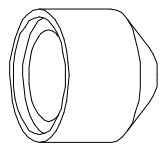
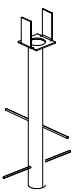
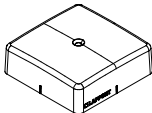
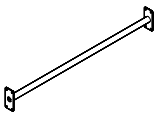
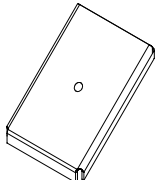
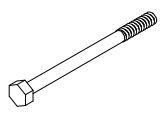
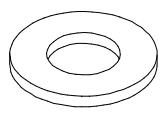
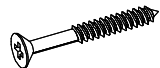
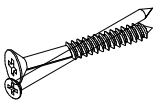
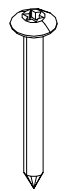
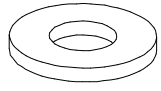

DATE: 19.10.2023

702286  65x65	PCS 1	705335  118x118x1000	PCS 2	705388  118x118x2090	PCS 2	905103  PT -28/32-H	PCS 6	905104  M10	PCS 16	905761  120x120x700	PCS 4
905830  123x123x40	PCS 2	905838-216  L 1060	PCS 5	906583  129x181x14x3	PCS 4	909246  Ø12x140	PCS 6	909256  Ø16/8,4 A2	PCS 56	980100  Ø5x60	PCS 4
980104  Ø5x90	PCS 2	980114  Ø4x20	PCS 4	980123  Ø7x60 A2	PCS 56	980154  Ø24/13	PCS 6		PCS		PCS
	PCS		PCS		PCS		PCS		PCS		PCS
	PCS		PCS		PCS		PCS		PCS		PCS
	PCS		PCS		PCS		PCS		PCS		PCS
	PCS		PCS		PCS		PCS		PCS		PCS