

LAPPSET®

FINNO



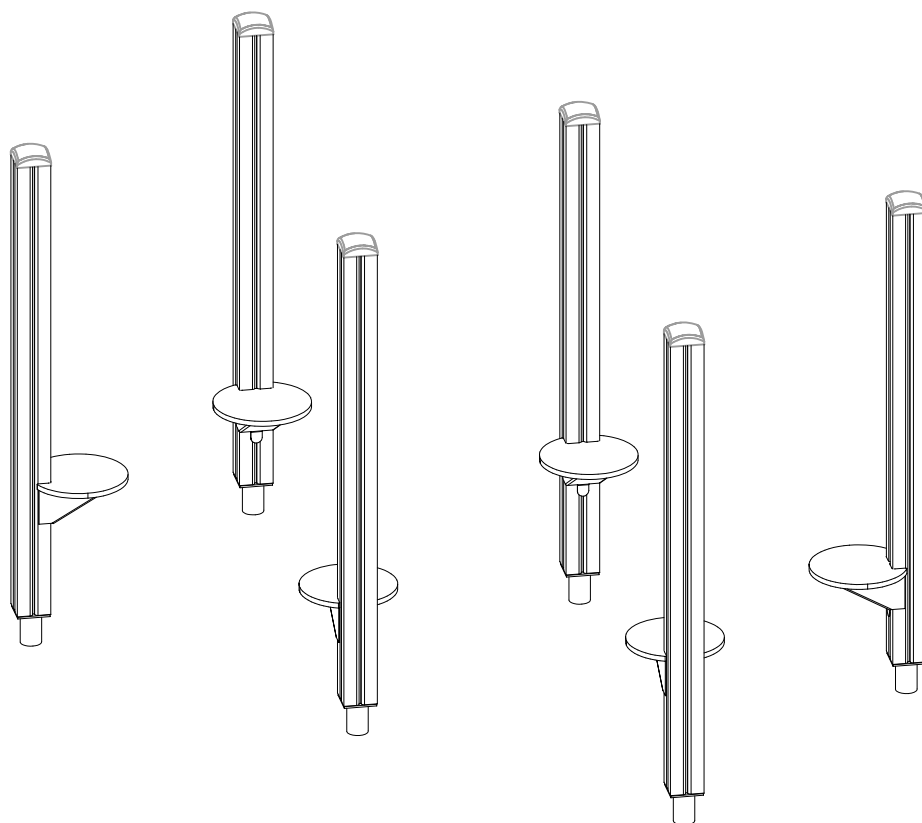

ASENNUSOHJE
MONTERINGSANSVISNING
INSTALLATION INSTRUCTION
AUFBAUANLEITUNG
NOTICE D'INSTALLATION

DATE: 10.6.2021

Q11991-1

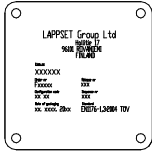
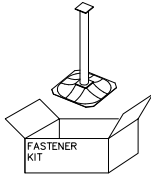

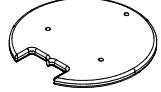
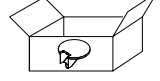
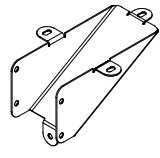
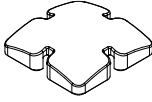
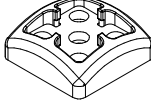
DATE: 10.6.2021

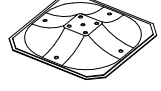
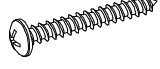
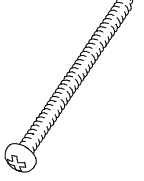
702286	PCS	706531	PCS	707420	PCS	707696-704	PCS	707729	PCS	902086	PCS
	1		6		6		6		6		6
65x65				93x93x1370		15x265x275				148x172x254	
905138	PCS	905196	PCS	909511	PCS	909519	PCS	980114	PCS	980131	PCS
	6		6		6		6		4		24
GRAY		GRAY		90x90x650		50x380x380		Ø4x20		Ø6x60	
	PCS		PCS		PCS		PCS		PCS		PCS
	PCS		PCS		PCS		PCS		PCS		PCS
	PCS		PCS		PCS		PCS		PCS		PCS
	PCS		PCS		PCS		PCS		PCS		PCS

----- Falling Space 19.7 m2

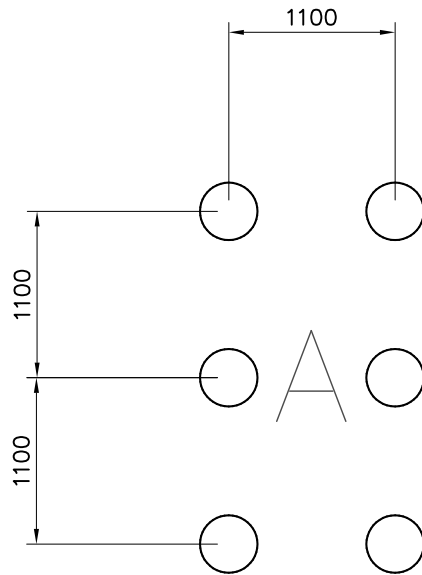

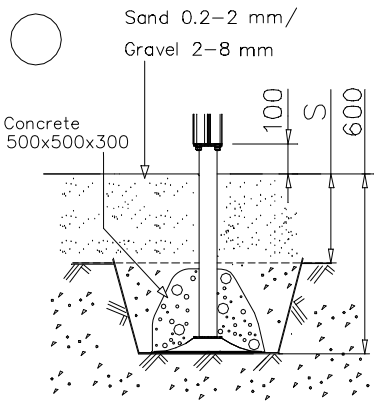
 <p>Sand 0.2–2 mm/ Gravel 2–8 mm</p> <p>Concrete 500x500x300</p> <p>100</p> <p>S</p> <p>600</p>		

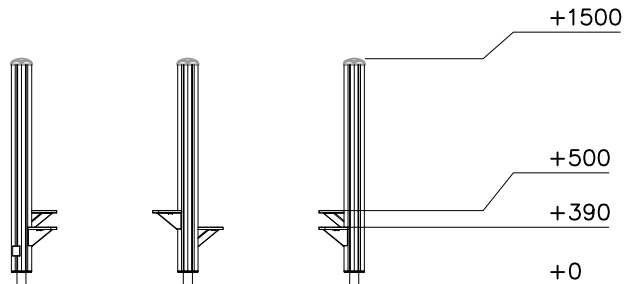
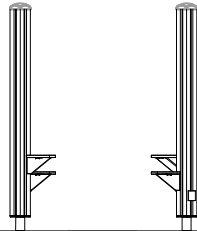

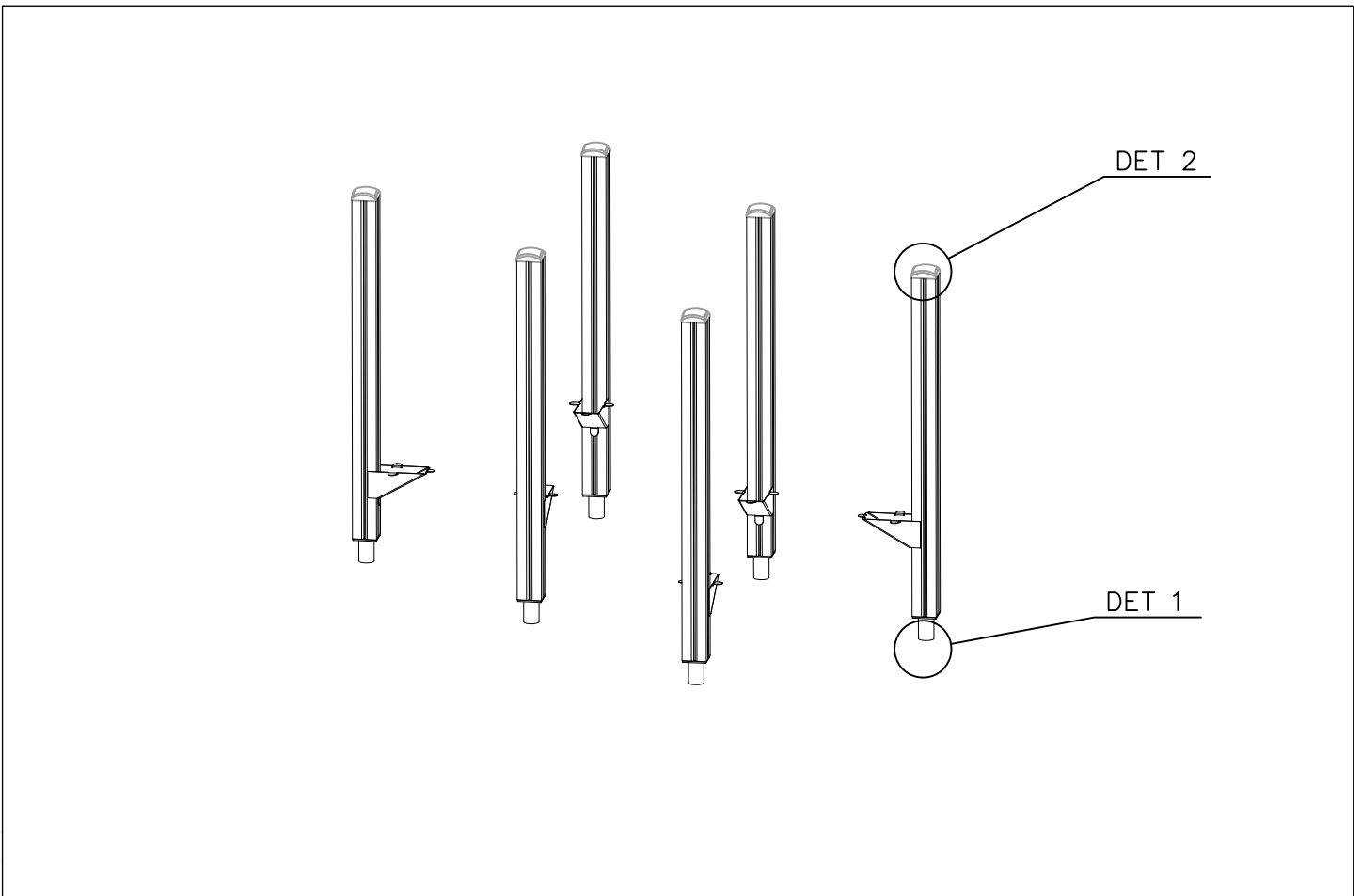
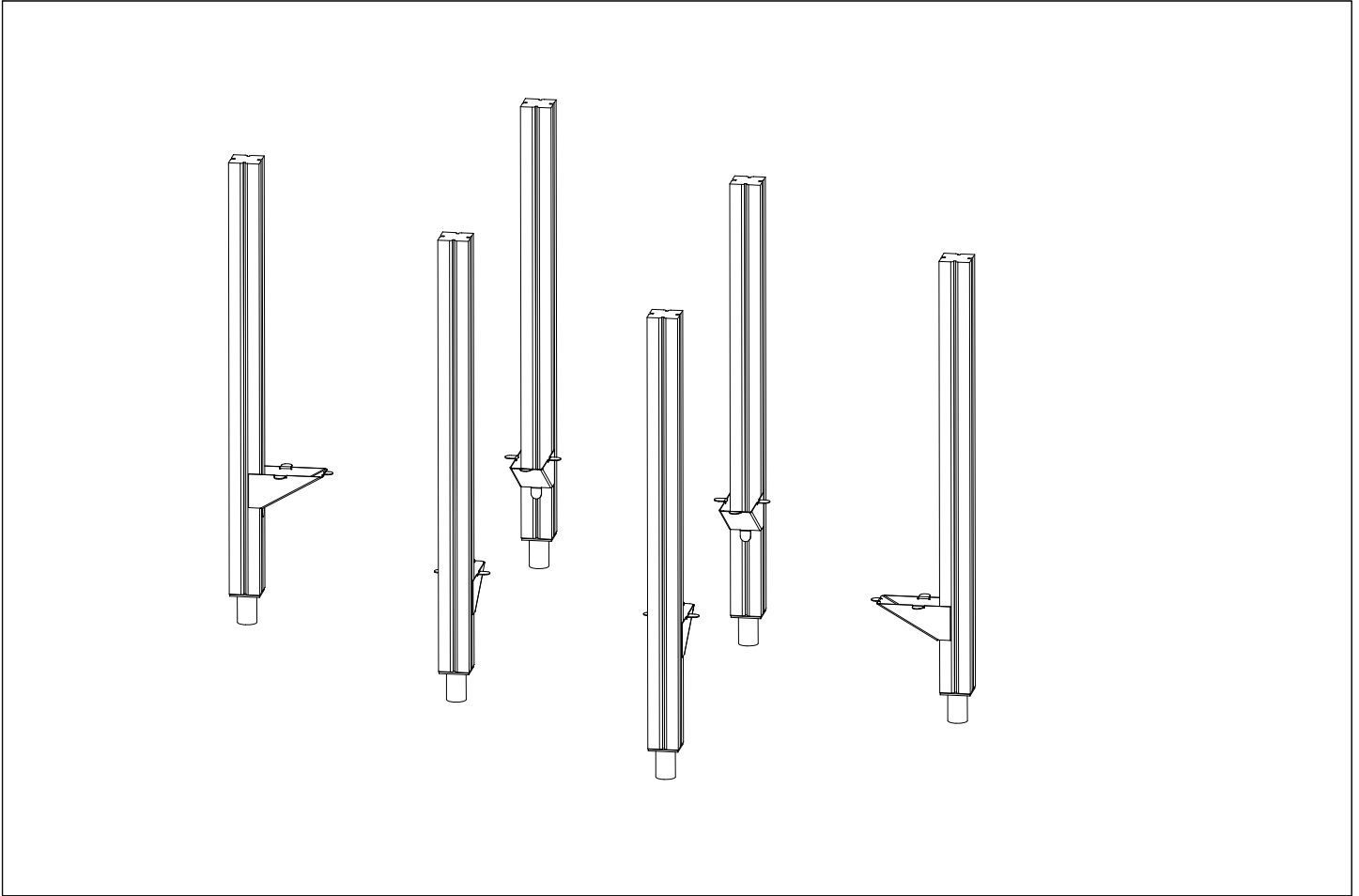

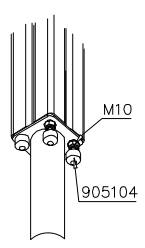
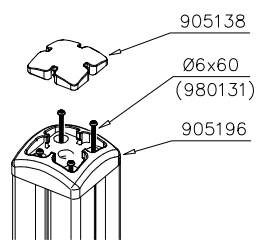
<p>DET 1</p> 	<p>DET 2</p> 		

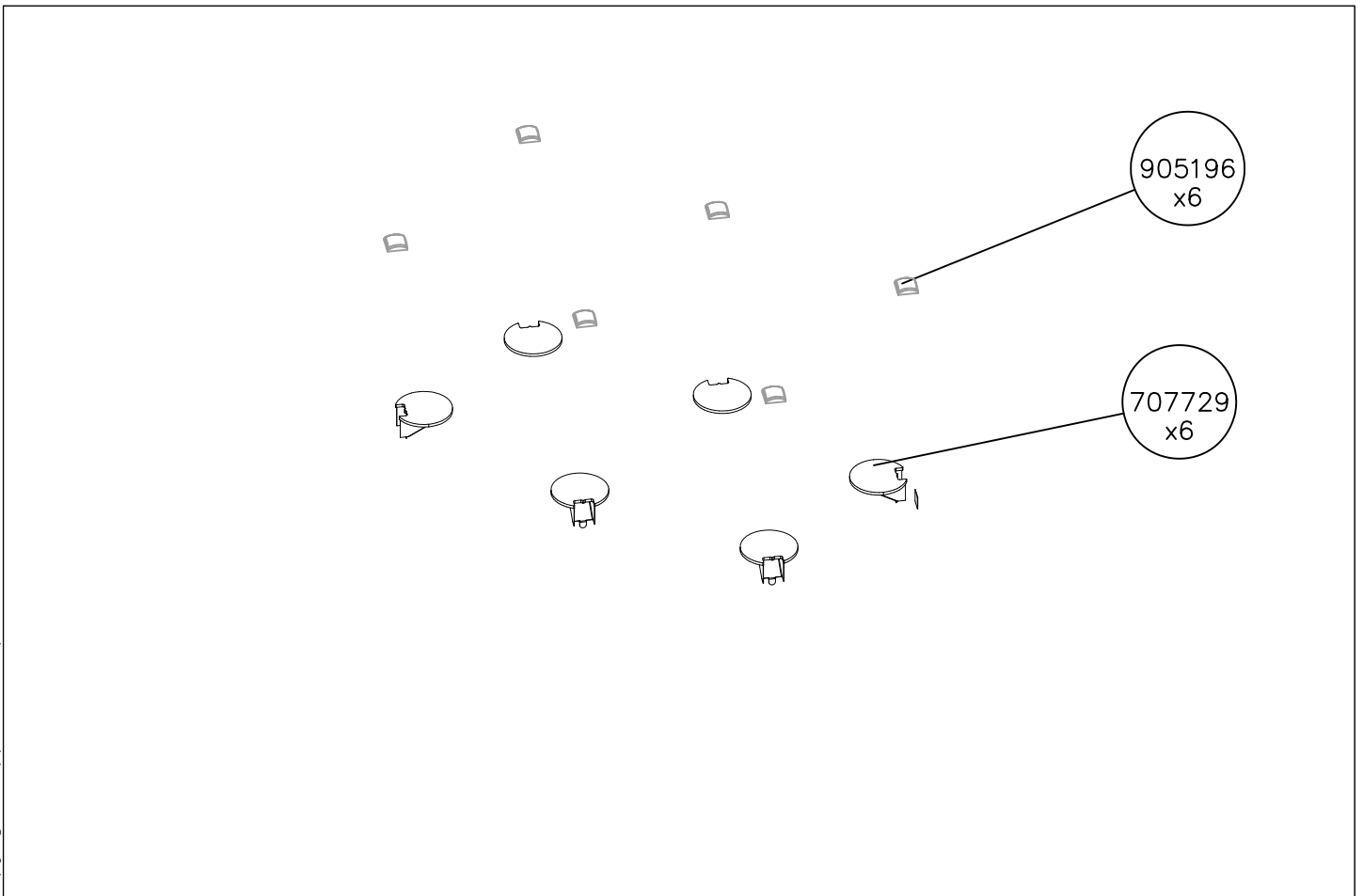
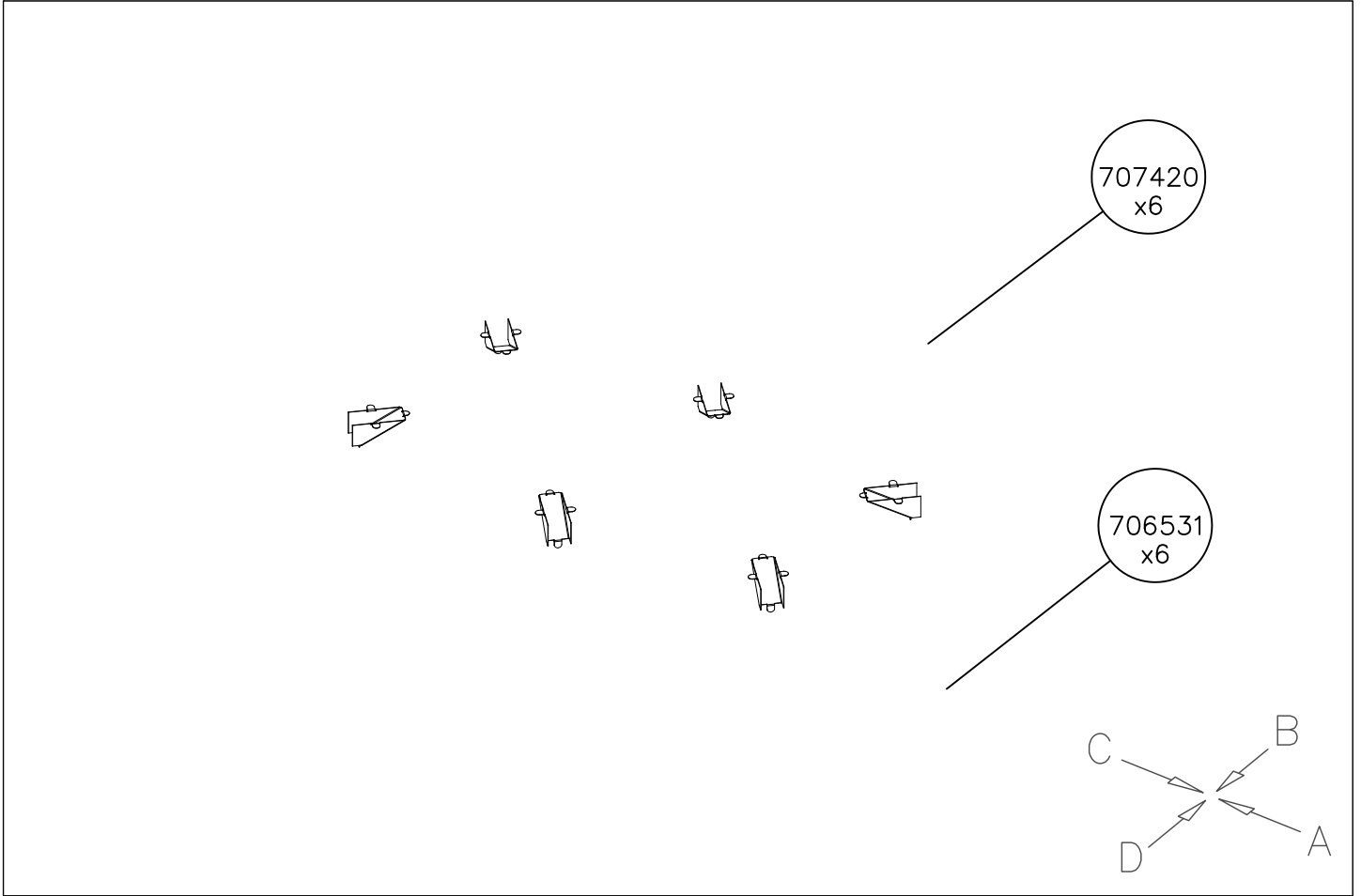

DATE: 10.6.2021

1:50

A

B

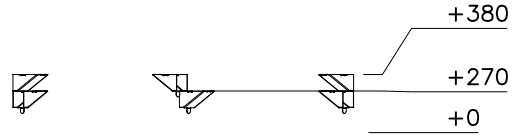
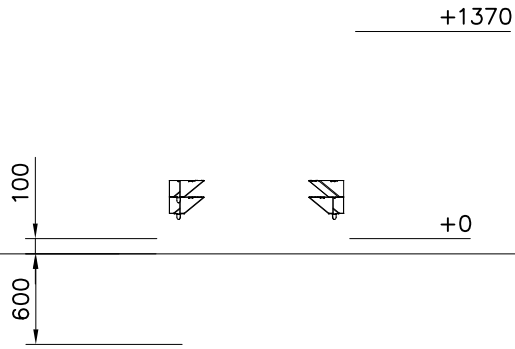

C

D



