

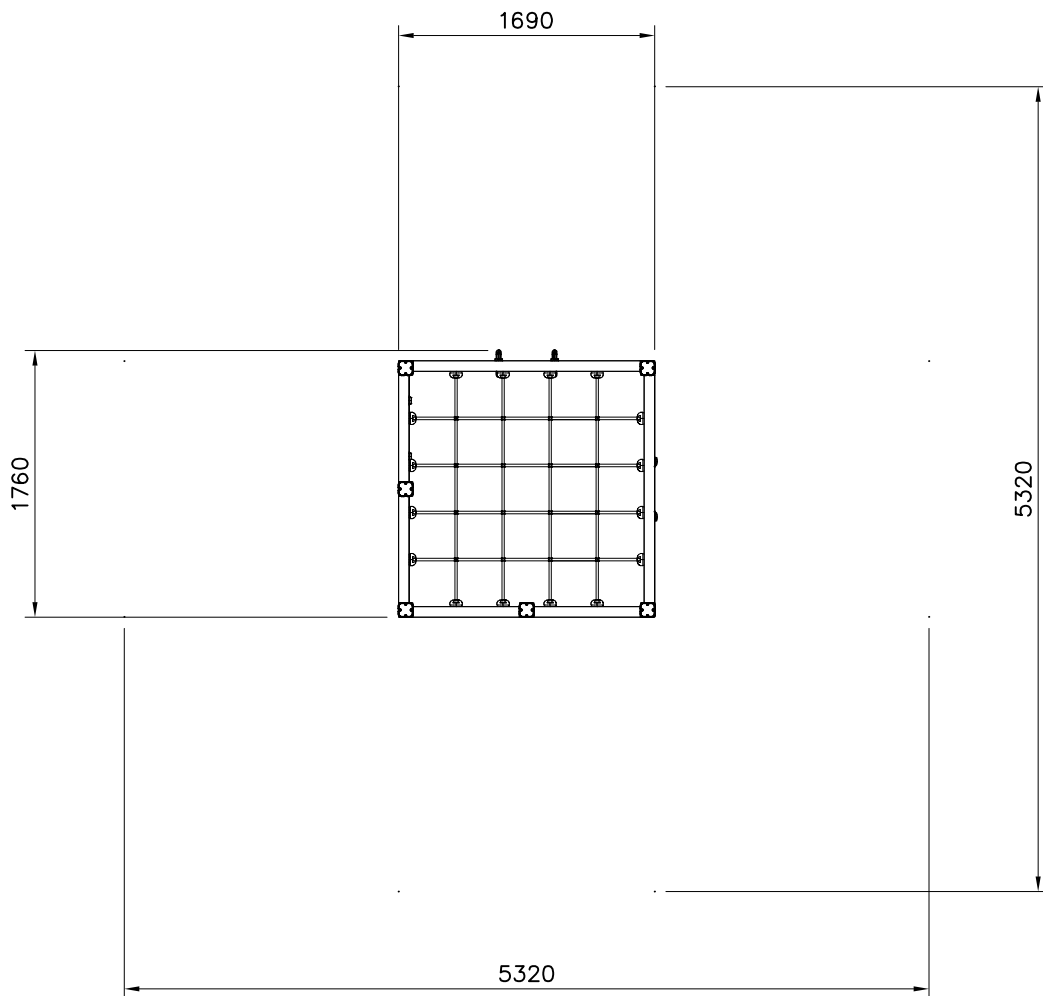

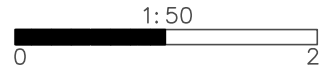

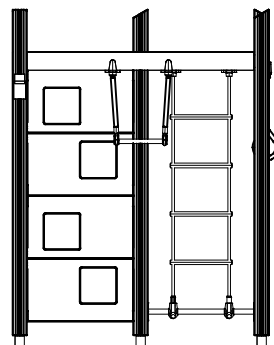

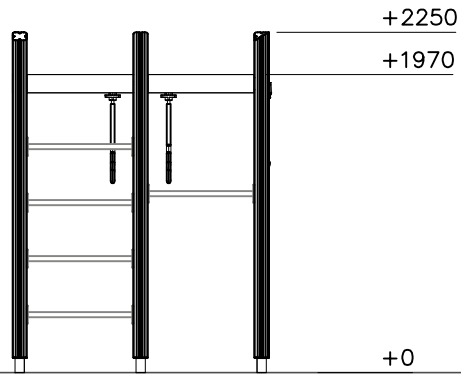

- EN/AS Impact Area 25.5 m²
- Falling Space 25.5 m²
Max Falling Height 1970 mm

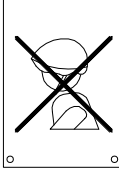

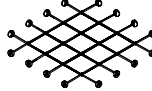
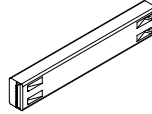
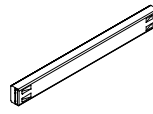
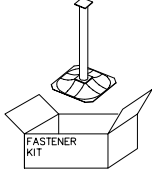
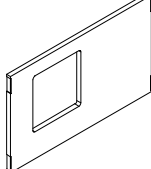
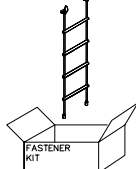
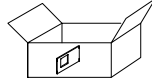
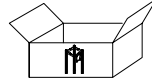
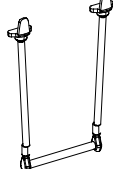
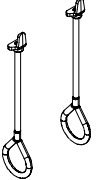
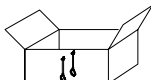
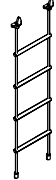
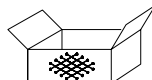
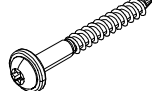

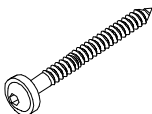
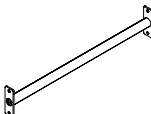
DATE: 14.9.2023

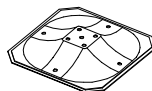
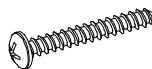
702286  65x65	PCS 1	702339  118x78	PCS 1	705207  l=2146	PCS 6	706485-303  1555x1555	PCS 1	706512  70x120x704	PCS 4	706514  70x120x1504	PCS 2
706531  FASTENER KIT	PCS 6	706540-707  20x702x415	PCS 4	706546  FASTENER KIT	PCS 1	706557 	PCS 4	706559 	PCS 1	706600-303 	PCS 1
706735-303 	PCS 1	706742 	PCS 1	706780-303 	PCS 1	706932 	PCS 1	900240  Ø8x70	PCS 20	901902  30.7x60.9x100	PCS 4
903093  Ø8x90	PCS 24	907694-216  L 704	PCS 6	909511  90x90x650	PCS 6	909519  50x380x380	PCS 6	980114  Ø4x20	PCS 8		PCS
	PCS		PCS		PCS		PCS		PCS		PCS
	PCS		PCS		PCS		PCS		PCS		PCS
	PCS		PCS		PCS		PCS		PCS		PCS