

# LAPPSET®

## FINNO







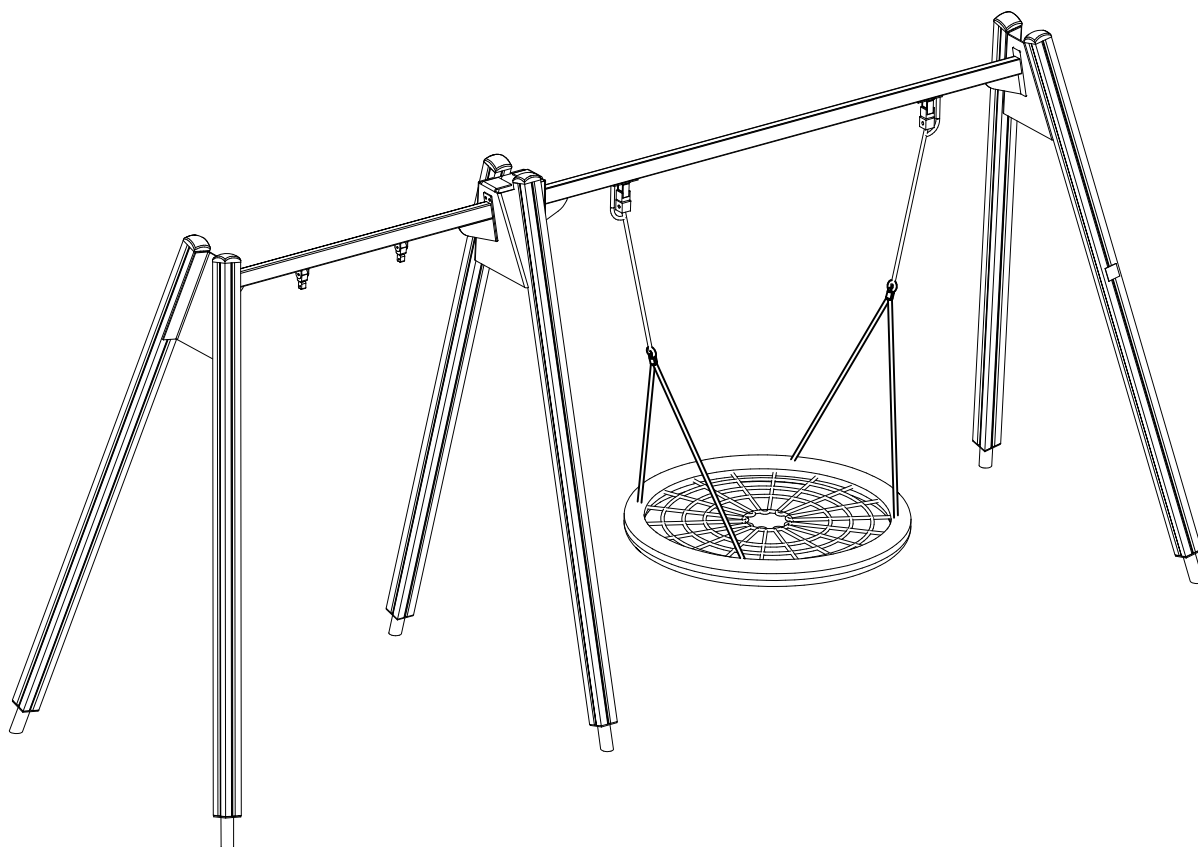



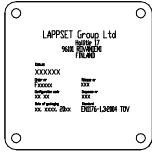
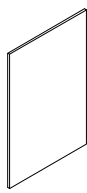

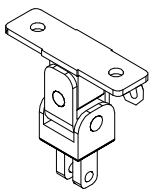

ASENNUSOHJE  
MONTERINGSANSVISNING  
INSTALLATION INSTRUCTION  
AUFBAUANLEITUNG  
NOTICE D'INSTALLATION

DATE: 14.3.2019

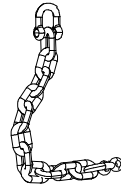
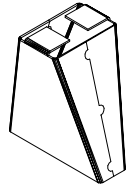
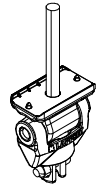
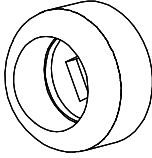
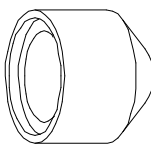
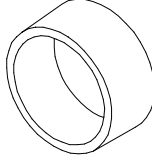
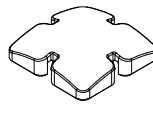
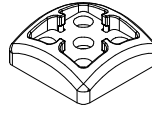
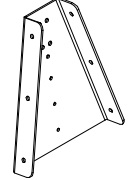
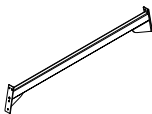
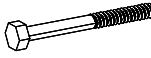
### Q11576-2

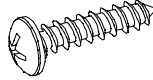
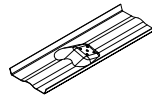
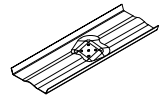

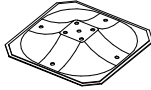
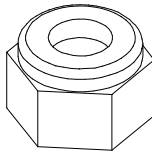
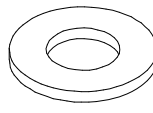
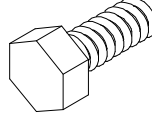
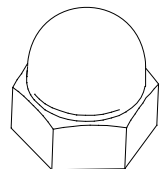
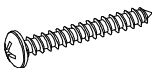
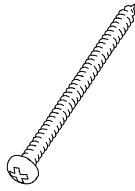
DATE: 14.3.2019

702286  65x65	PCS 1	702533  118x78	PCS 1	703248 	PCS 1	706564  L2650	PCS 6	900965  M10	PCS 8	901958 	PCS 2
901959  L2940	PCS 1	902234  M12	PCS 4	903149  M12x30	PCS 8	903577 	PCS 2	904317 	PCS 1	904904 	PCS 2
905090  Ø45	PCS 18	905104  M10	PCS 24	905115  Ø30	PCS 18	905138 	PCS 6	905196 	PCS 6	905991 	PCS 2
906216  L1690	PCS 1	906499  M12x110	PCS 4	909347  M12x35	PCS 18	909506  Ø3.5x13	PCS 4	909507  L 1000	PCS 2	909508  L 1000	PCS 2
909511  L650	PCS 6	909519  50x380x380	PCS 2	909637  M10	PCS 24	909638  Ø20/10.5	PCS 64	909639  M10x25	PCS 32	909644  M12	PCS 8
980114  Ø4x20	PCS 4	980131  Ø6x60	PCS 24	980154  Ø24x13	PCS 42	999561  10g	PCS 1		PCS		PCS
	PCS		PCS		PCS		PCS		PCS		PCS

—— EN/AS Impact Area 34.3 m<sup>2</sup>  
- - - - Falling Space 34.3 m<sup>2</sup>  
Max Falling Height 1400 mm

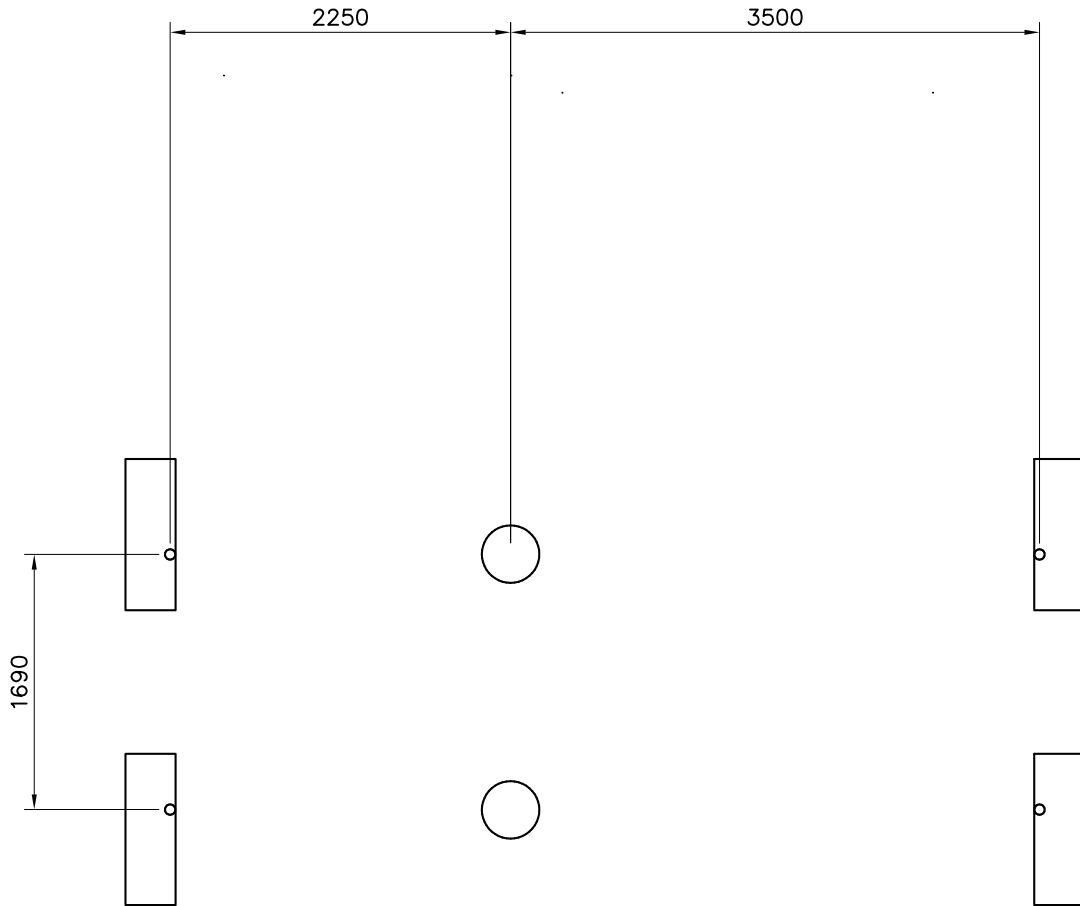
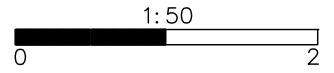

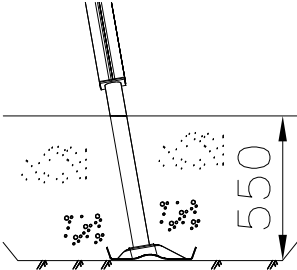
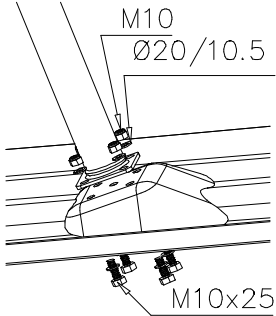
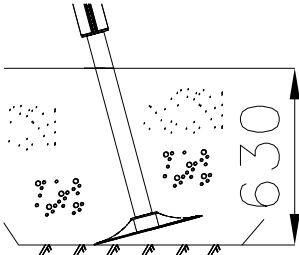
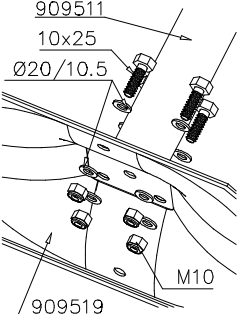
 <p>550</p>	 <p>M10 Ø20/10.5 M10x25</p>	 <p>630</p>
 <p>909511 10x25 Ø20/10.5 M10 909519</p>		

- EN/AS Impact Area 34.3 m<sup>2</sup>
- - - Falling Space 34.3 m<sup>2</sup>  
Max Falling Height 1400 mm

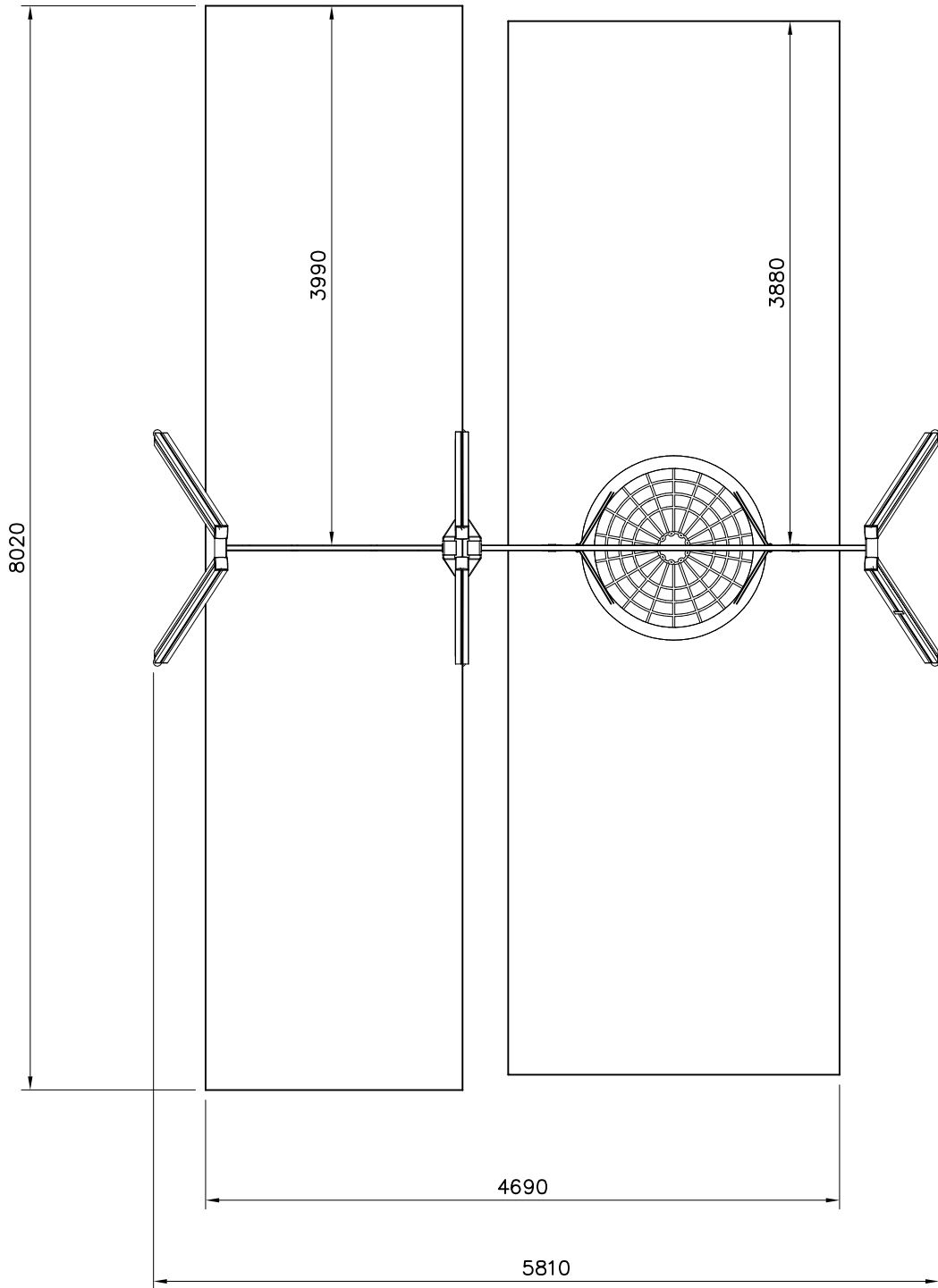
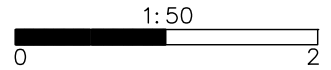

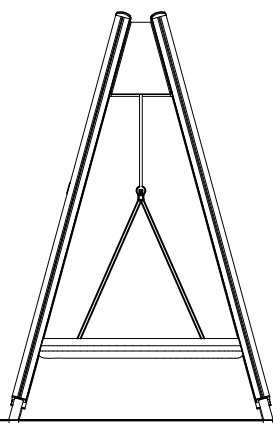
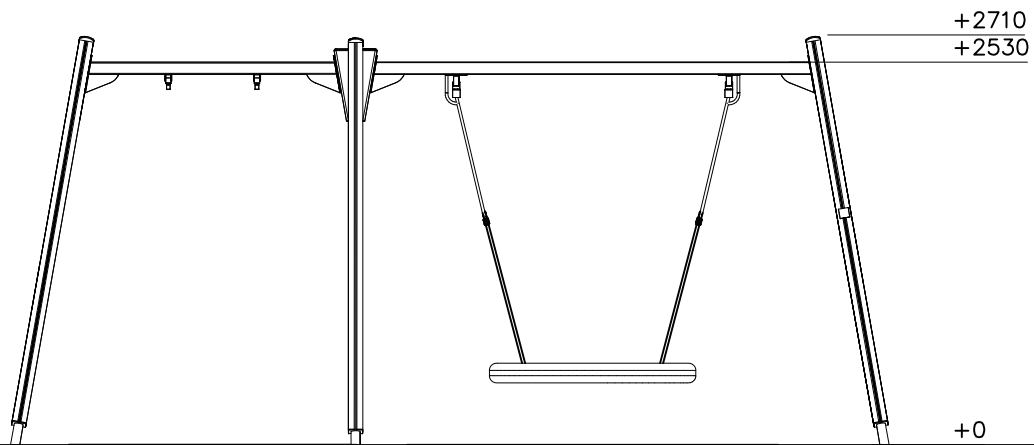

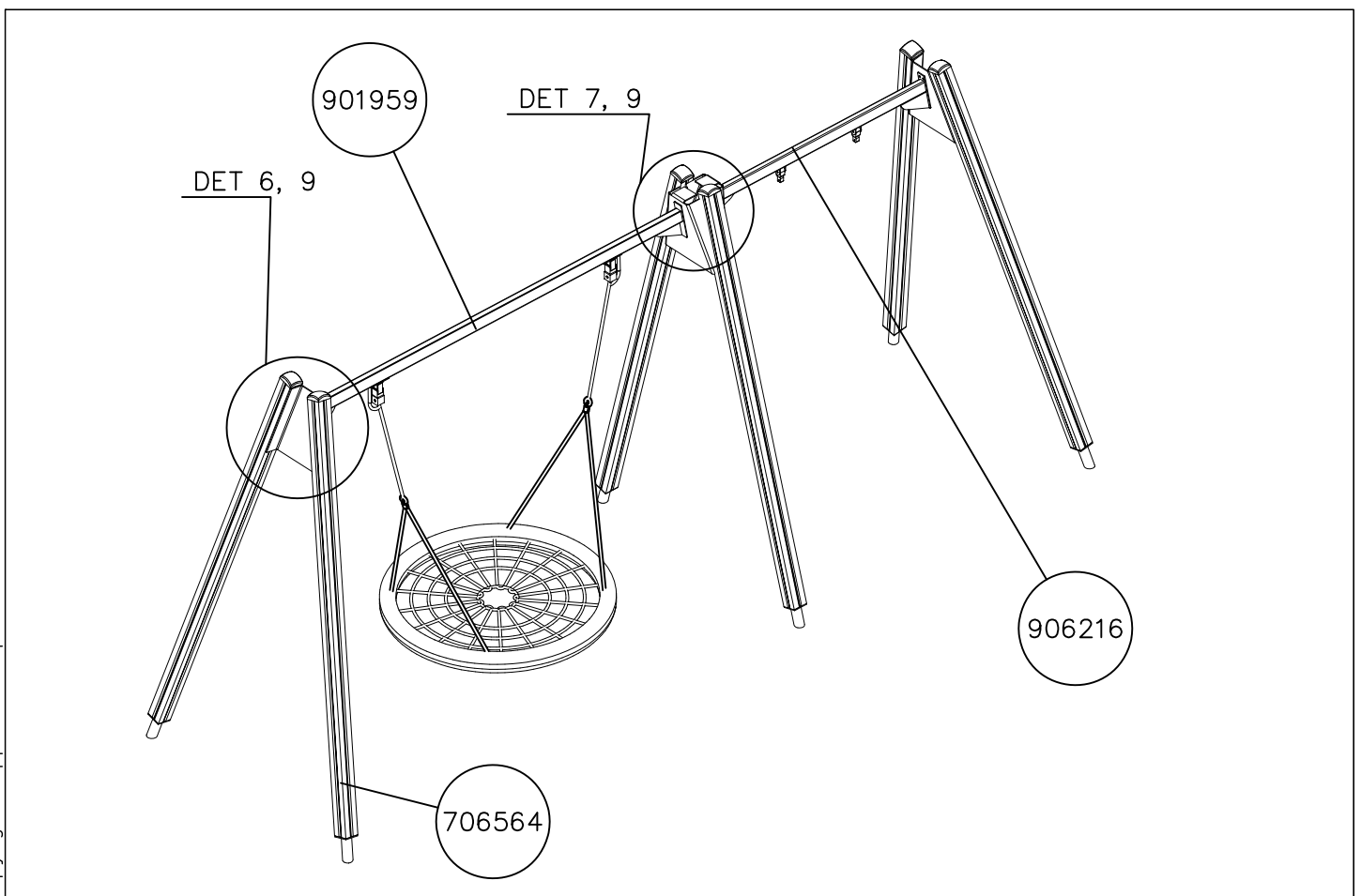
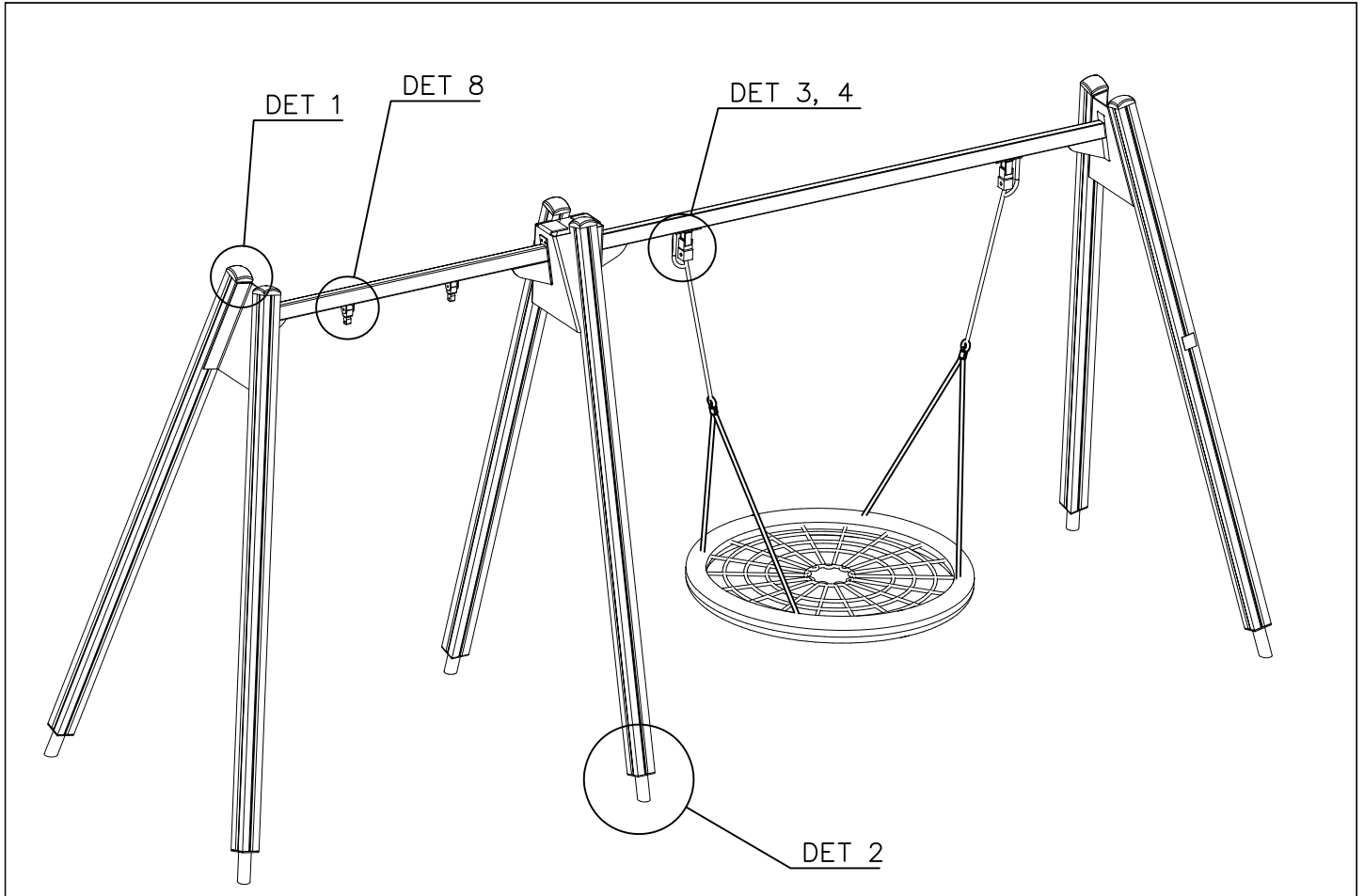

<p>DET 1</p> <p>6x60 980131</p>	<p>DET 2</p> <p>M10 905104 909521</p>	<p>DET 3</p> <p>901958 903577</p>	<p>DET 4</p> <p>M12x110 Ø24/13 901958 M8x35 Ø24/13 M12 M8 CUT EXTRA CHAIN</p>
<p>DET 5</p> <p>&gt;400</p>		<p>DET 7</p> <p>904317</p>	<p>DET 8</p> <p>M12 980154 Ø24/13 904904</p>
<p>DET 9</p> <p>999561 GLUE Ø24/13 12x35 905115 905090</p>			
		<p>DET 6</p> <p>M12 → 80 Nm Ø24/13 M12x30 M12 M10x25 Ø20/10.5 M10 M10 → 45 Nm</p>	



