

# **LAPPSET®**

## **CLOVER**







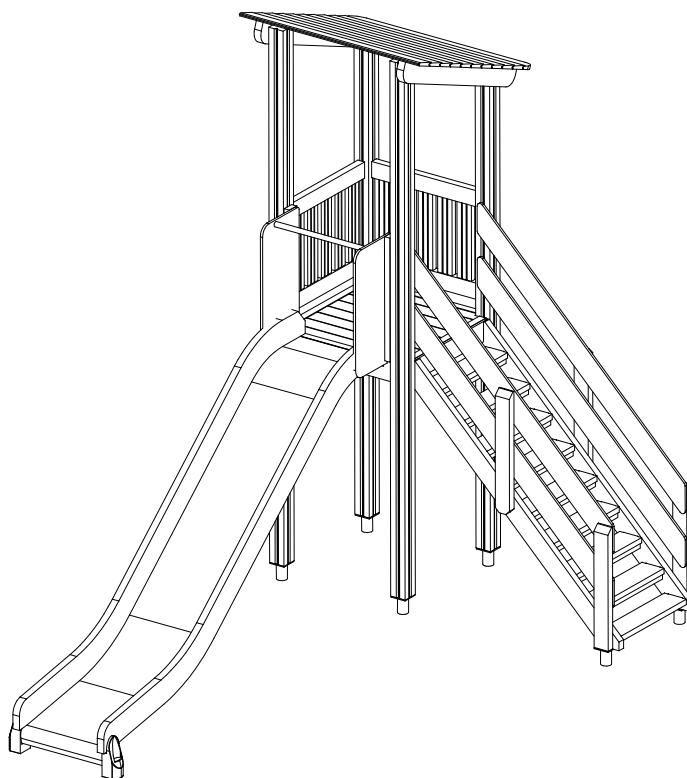



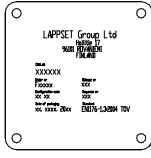

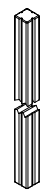
ASENNUSOHJE  
MONTERINGSANSVISNING  
INSTALLATION INSTRUCTION  
AUFBAUANLEITUNG  
NOTICE D'INSTALLATION

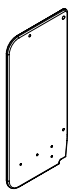
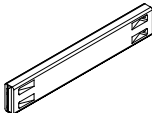
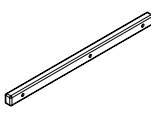
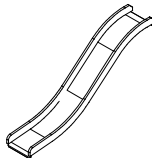
DATE: 29.2.2024

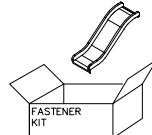
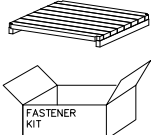
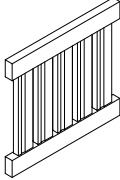
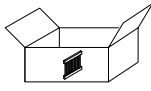
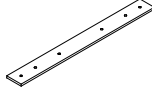
### **Q11059-1**

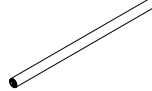

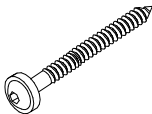
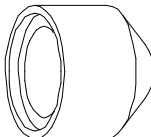
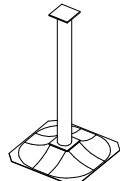
DATE: 29.2.2024

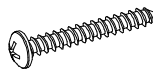
008986  750x750	PCS 1	702286  65x65	PCS 1	703139  	PCS 1	703332  L 2850	PCS 2	703333  L 3150	PCS 2	706371-705  15x345x750	PCS 2
706439  L 704	PCS 4	706443  32x45x702	PCS 2	706450-604  600x381x2685	PCS 1	706505  35x70x730	PCS 2	706533  FASTENER KIT	PCS 1	706535  FASTENER KIT	PCS 1
706746  45x640x701	PCS 2	706748 	PCS 2	707133  10x80x745	PCS 1	707326  FASTENER KIT	PCS 1	901868  Ø34x598	PCS 3	901879 	PCS 2
903093  Ø8x90	PCS 16	905104 	PCS 16	909521  	PCS 6	980114  Ø4x20	PCS 4		PCS		PCS
	PCS		PCS		PCS		PCS		PCS		PCS
	PCS		PCS		PCS		PCS		PCS		PCS
	PCS		PCS		PCS		PCS		PCS		PCS

— EN/AS Impact Area 24.5 m<sup>2</sup>  
+ + + + + + + + + +  
- - - - Falling Space 26.7 m<sup>2</sup>  
Max Falling Height 0000 mm

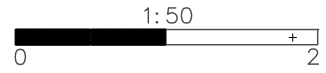

Grid size = 1000 mm

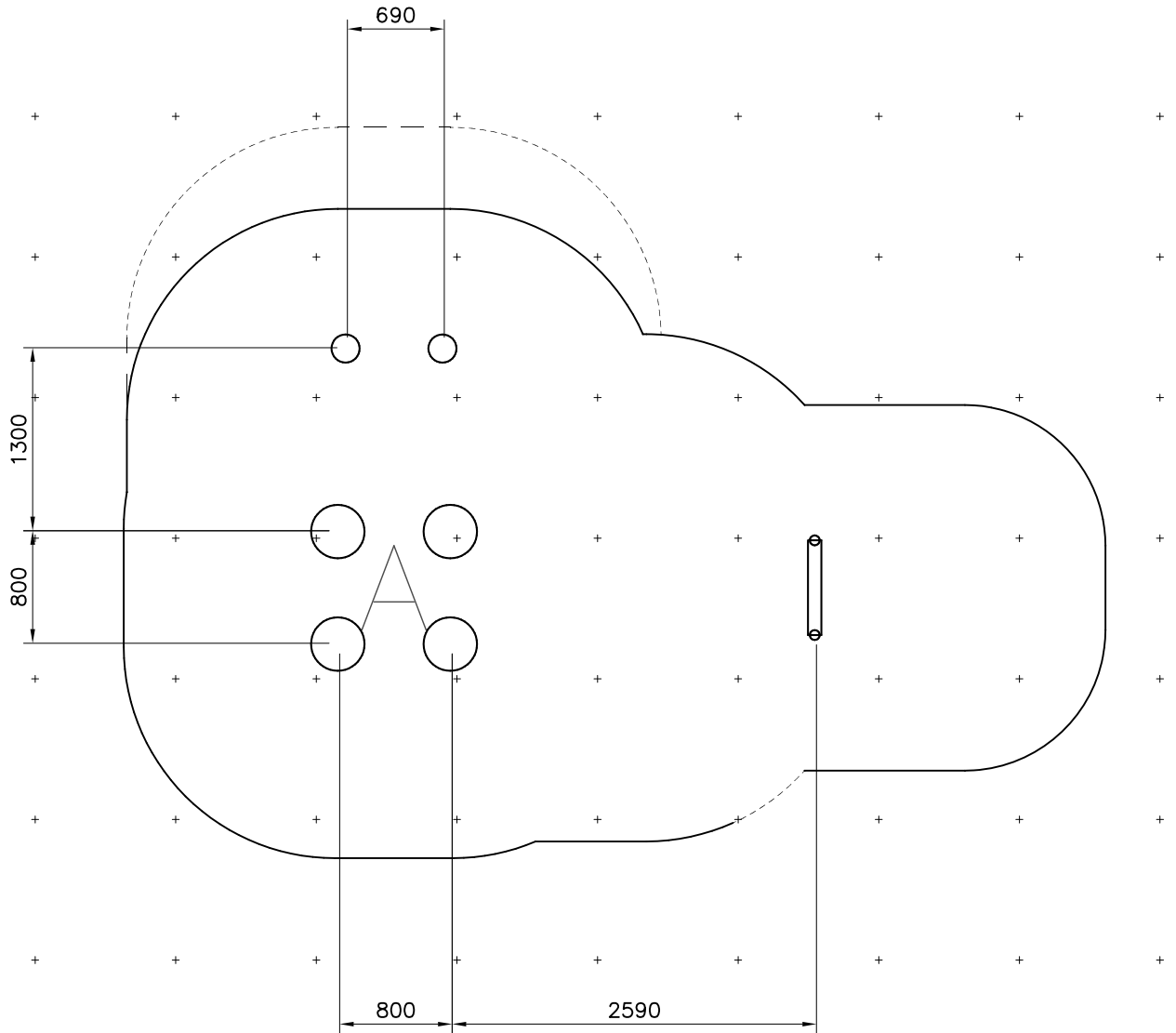

- EN/AS Impact Area 24.5 m<sup>2</sup>
- - - Falling Space 26.7 m<sup>2</sup>  
Max Falling Height 0000 mm

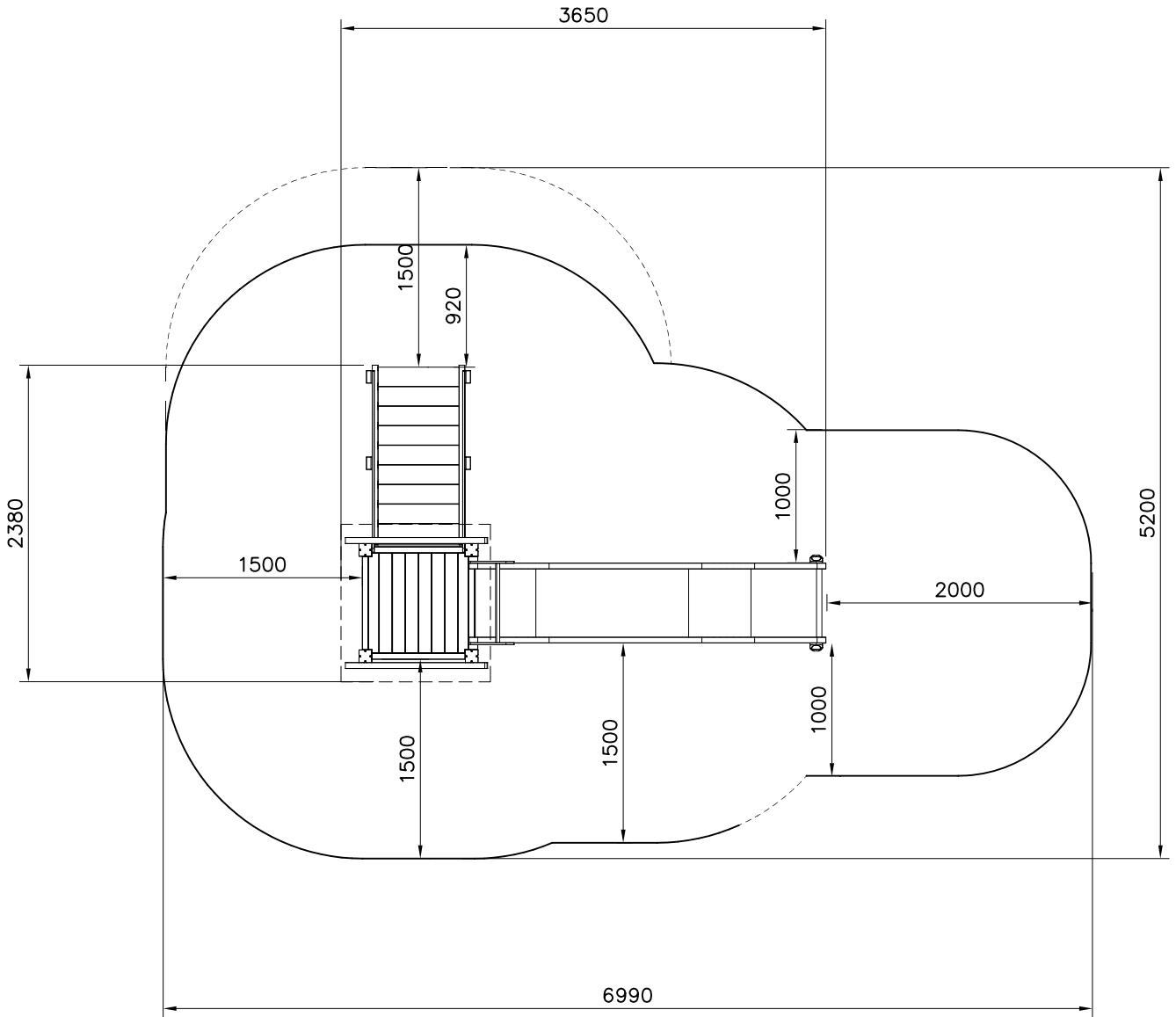
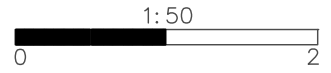

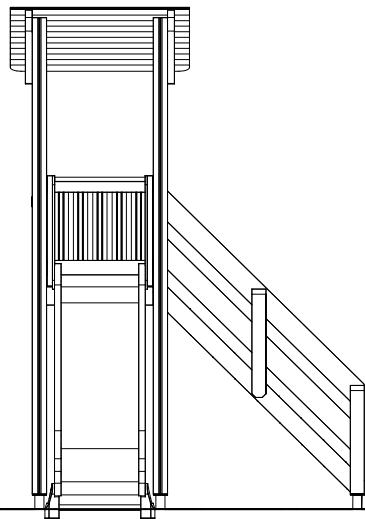
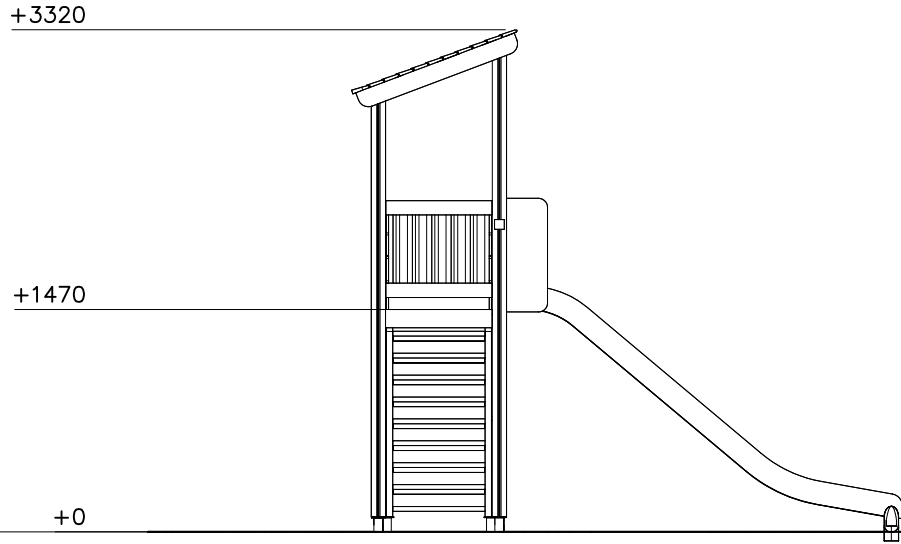

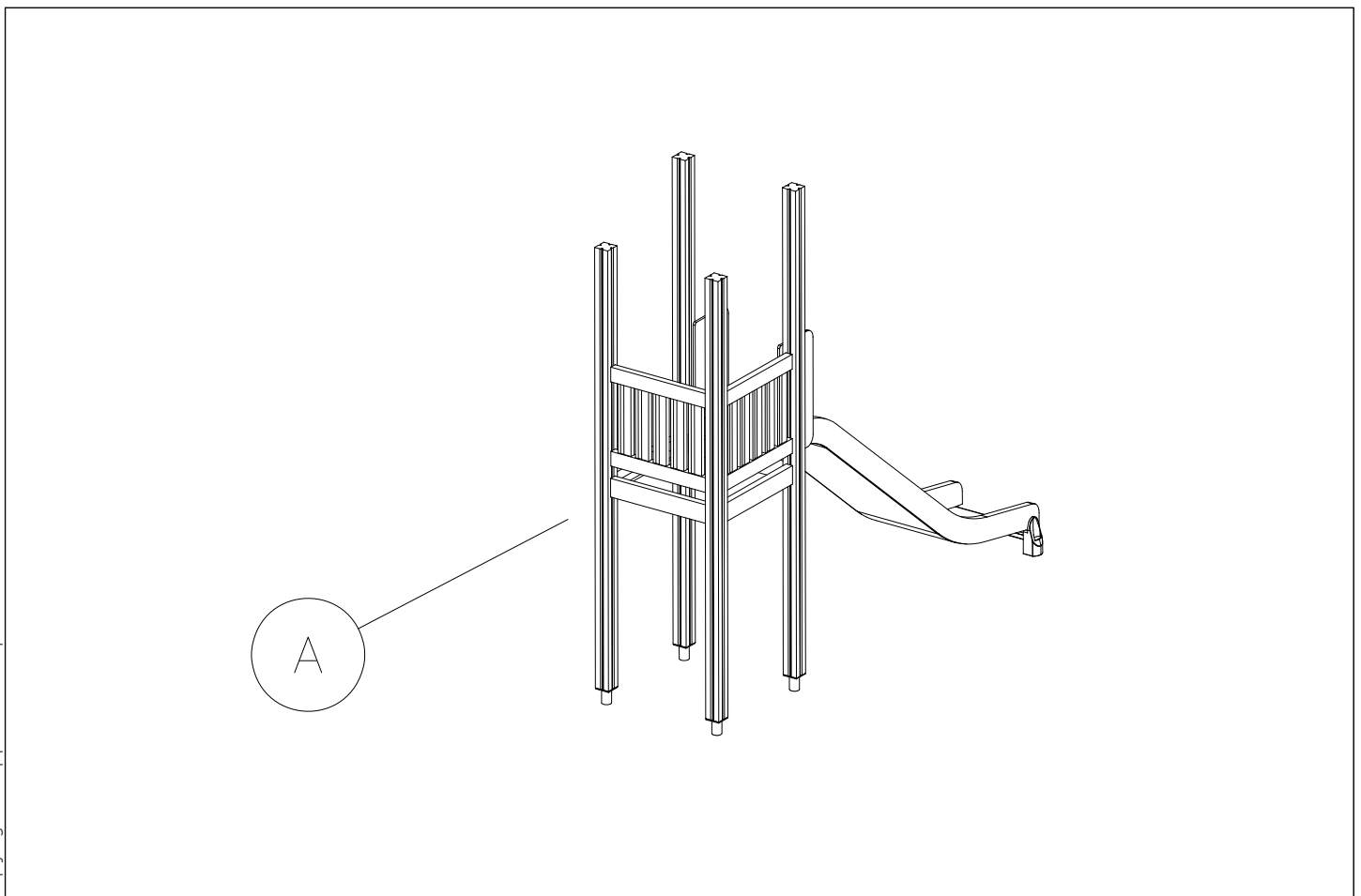
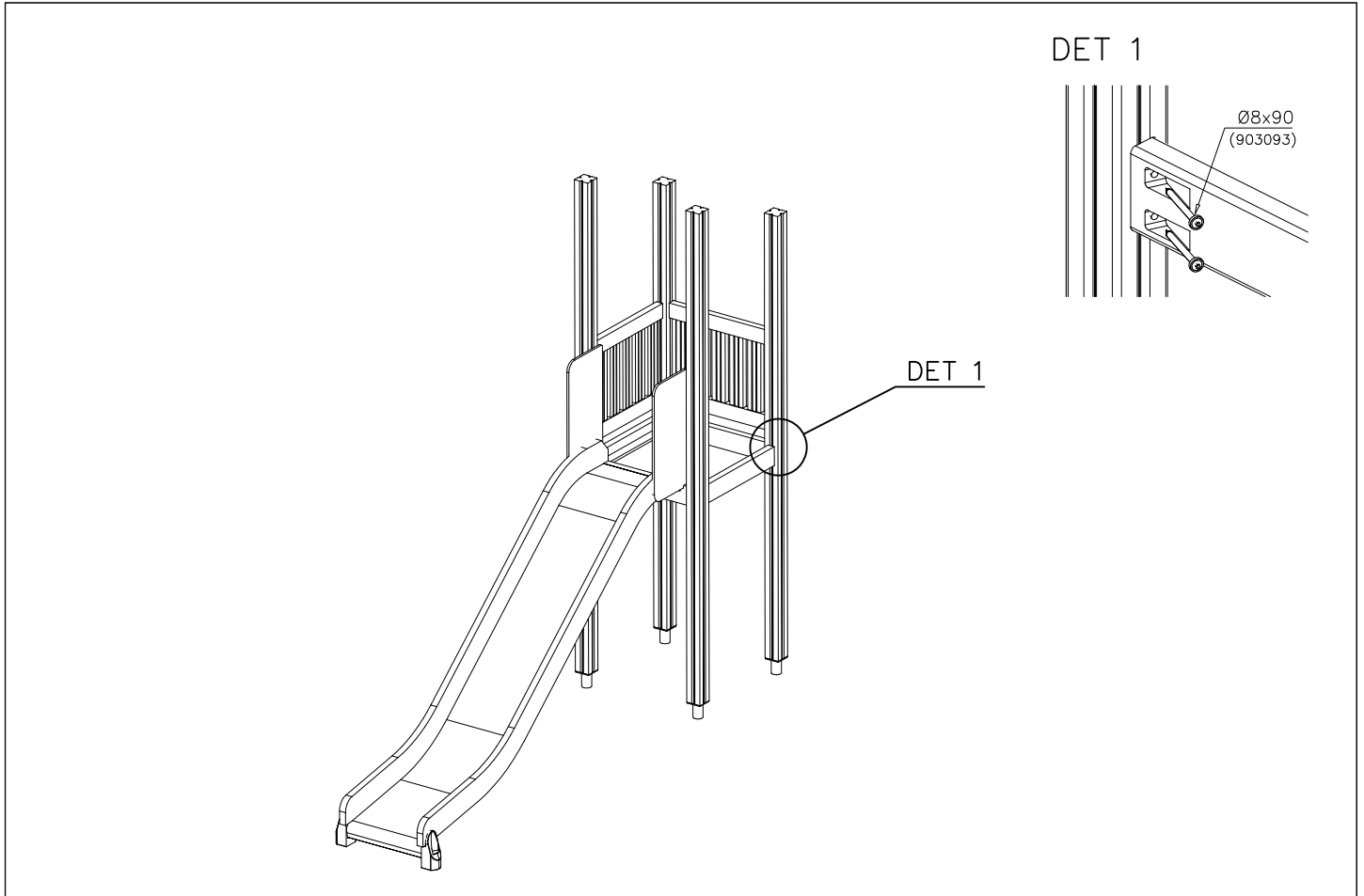

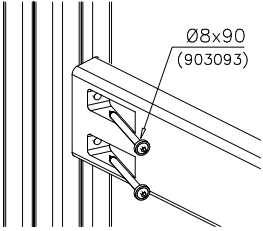
DATE: 29.2.2024



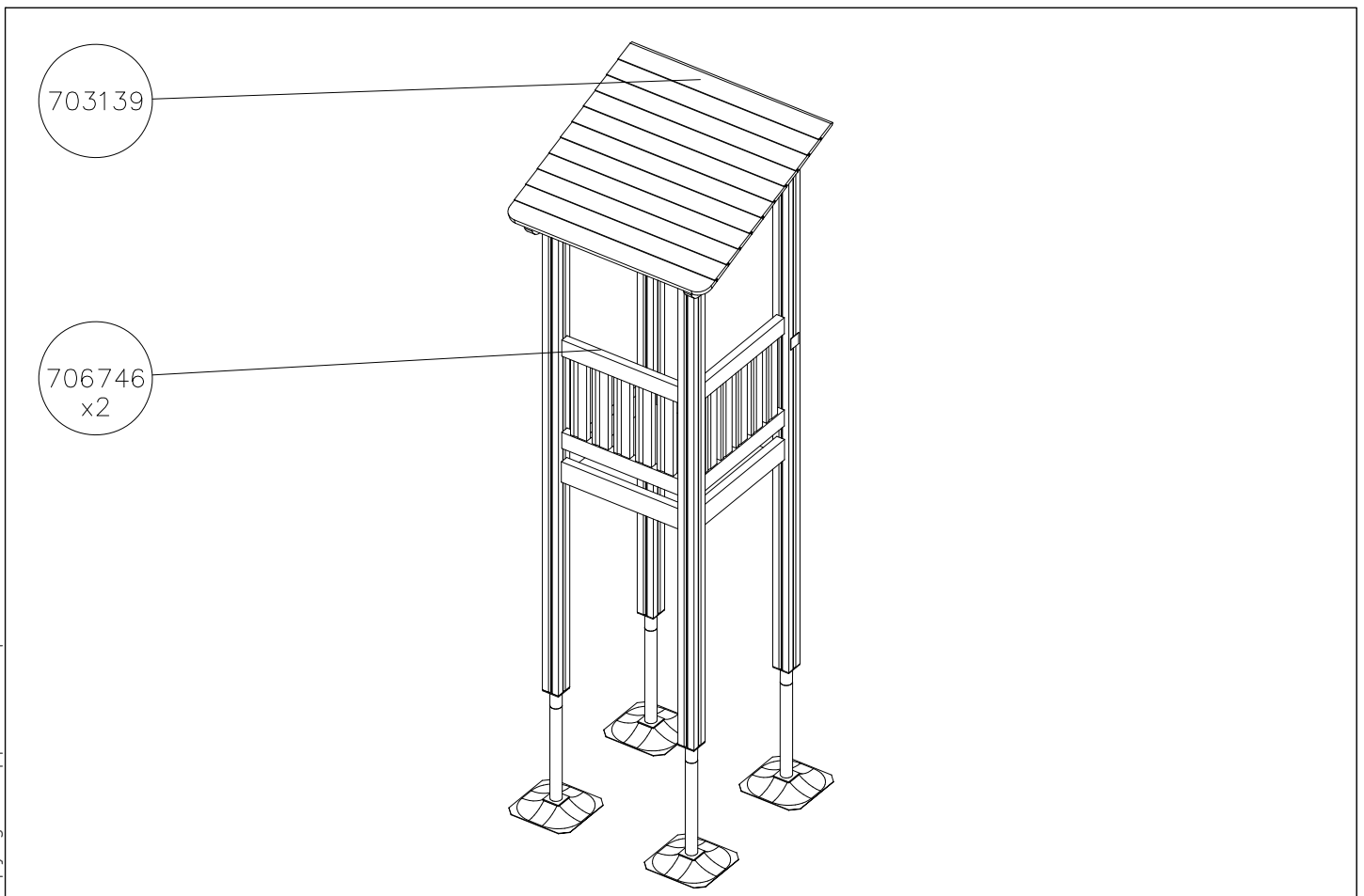
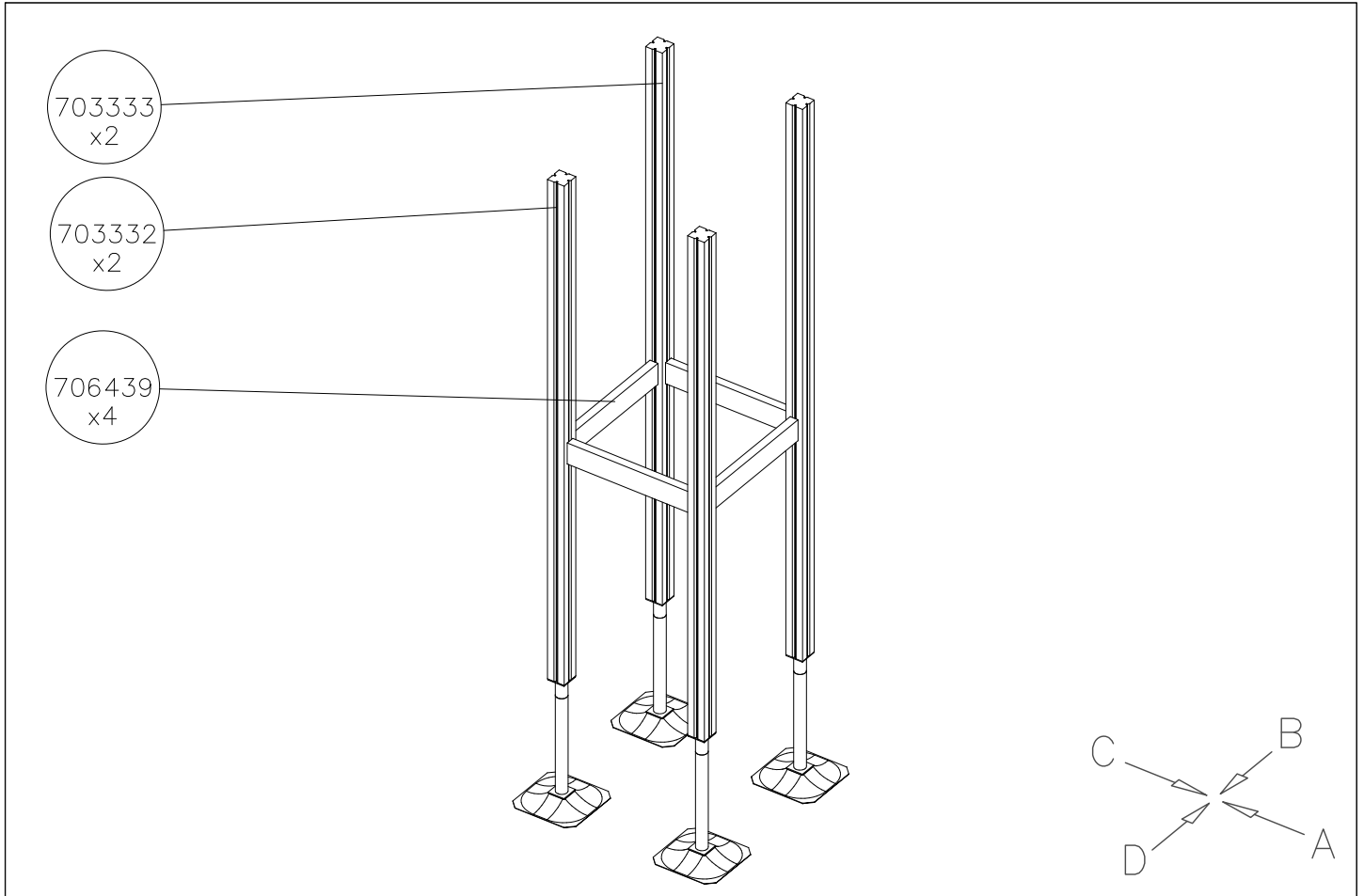

DATE: 29.2.2024

1:50

A

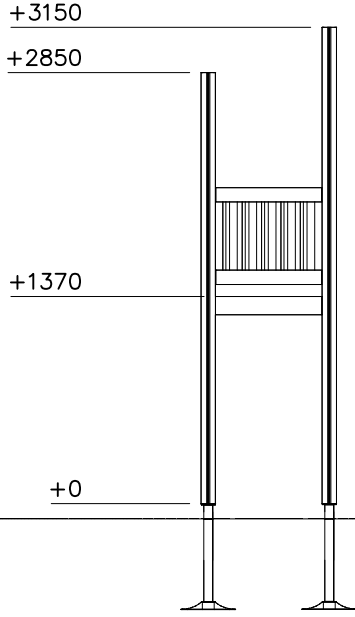

B

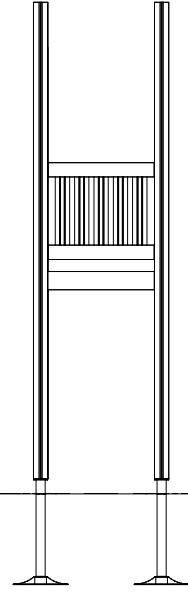

C

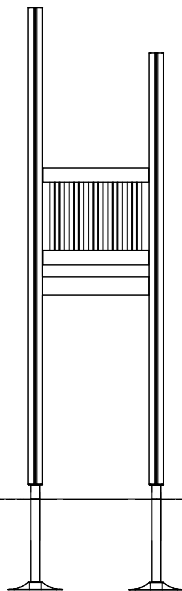

D

