

# LAPPSET®

## FINNO







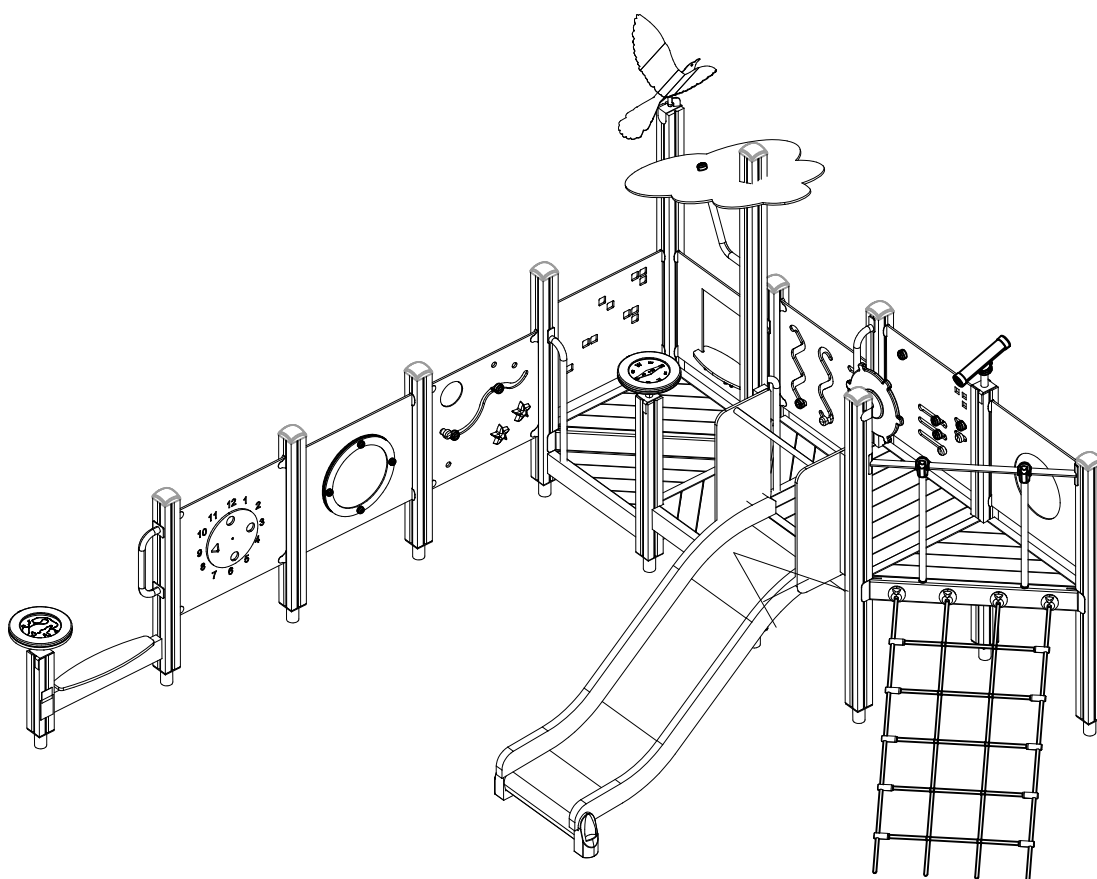

ASENNUSOHJE  
MONTERINGSANSVISNING  
INSTALLATION INSTRUCTION  
AUFBAUANLEITUNG  
NOTICE D'INSTALLATION

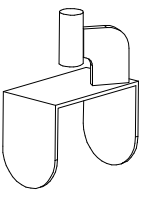
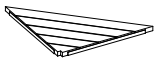
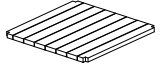

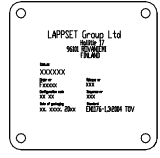
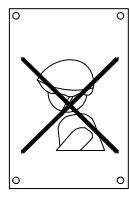
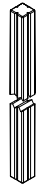
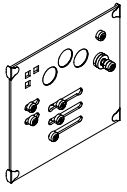

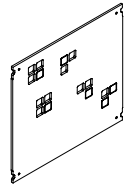
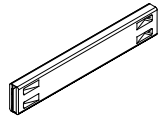
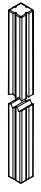
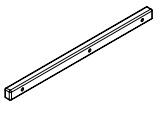
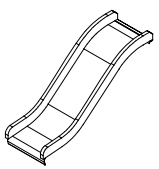
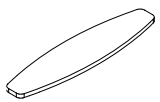

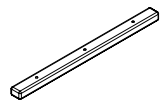
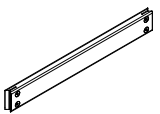
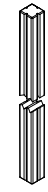
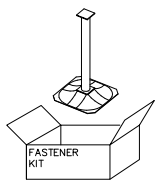
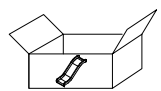
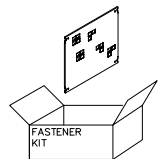
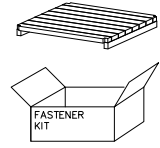
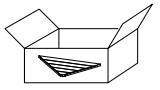
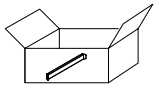
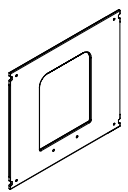
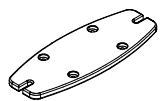
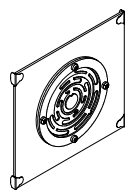
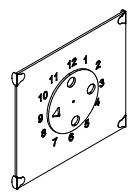
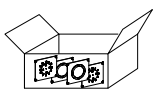
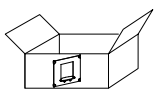
DATE: 24.4.2017

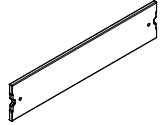
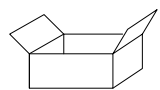
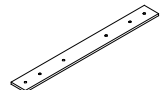
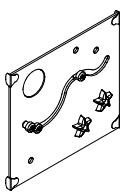
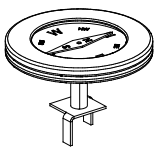
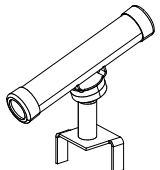
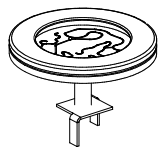
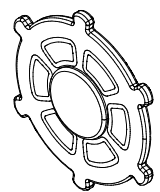
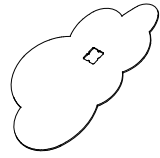
### Q10865-1

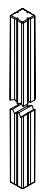
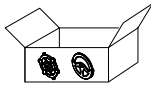
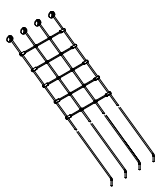
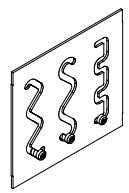
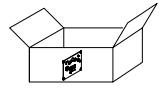
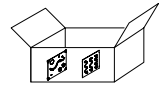
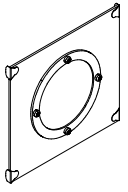
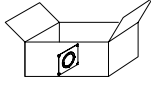
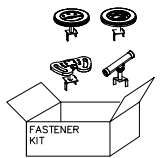
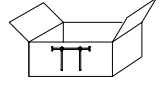
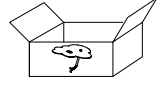
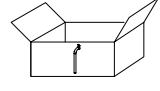
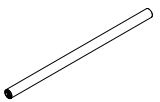

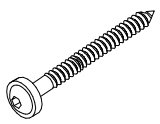
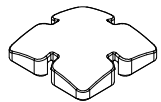
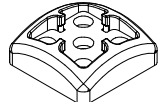
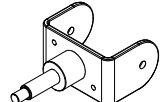
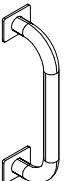
DATE: 17.1.2020

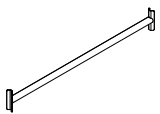
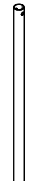
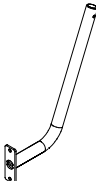
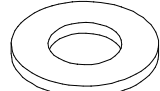
003894  1 32x714x714	PCS 1	008985  5 750x750	PCS 5	008986  1 L 1250	PCS 1	701401  2 65x65	PCS 2	702286  1 118x78	PCS 1	702339  1	PCS 1
704417  93x93x2900	PCS 1	705705-704  10x640x702	PCS 1	706371-704  15x345x750	PCS 2	706436-704  10x640x702	PCS 1	706439  L 704	PCS 14	706441  93x93x1550	PCS 3
706443  32x45x702	PCS 2	706452-604  600x780x1470	PCS 1	706453  15x145x600	PCS 1	706466  93x93x1025	PCS 3	706505  35x70x730	PCS 2	706508  32x45x650	PCS 15
706510  45x120x1030	PCS 5	706511  93x93x1870	PCS 2	706531  FASTENER KIT	PCS 13	706533  FASTENER KIT	PCS 1	706534  FASTENER KIT	PCS 1	706535  FASTENER KIT	PCS 1
706537  FASTENER KIT	PCS 5	706538  FASTENER KIT	PCS 5	706727-704  10x702x640	PCS 1	706744  15x145x380	PCS 1	706766-704  FASTENER KIT	PCS 1	706772-704  FASTENER KIT	PCS 1
706778  FASTENER KIT	PCS 2	706885  FASTENER KIT	PCS 1	706894  L 950	PCS 1	706896  15x150x703	PCS 1	706897  FASTENER KIT	PCS 1	707133  10x80x745	PCS 1
707209-704  10x640x702	PCS 1	707303-704  FASTENER KIT	PCS 1	707304  FASTENER KIT	PCS 1	707305-704  FASTENER KIT	PCS 1	707320-702  FASTENER KIT	PCS 1	707328-704  10x750x1290	PCS 1

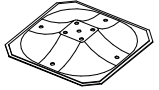
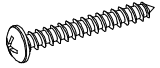
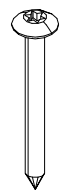
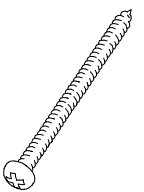
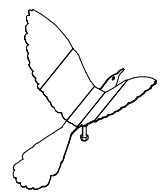
707331  93x93x470	PCS 1	707333 	PCS 1	707351-305 	PCS 1	707386-704  10x640x702	PCS 1	707449 	PCS 1	707450 	PCS 2
707453-704  10x640x702	PCS 1	707454 	PCS 1	707585  FASTENER KIT	PCS 3	707625 	PCS 1	707665 	PCS 1	707732 	PCS 5
901868  Ø34x598	PCS 3	901879 	PCS 2	903093  Ø8x90	PCS 56	905138  GRAY	PCS 9	905196  GRAY	PCS 9	905879 	PCS 1
906635-216 	PCS 1	907688-216 	PCS 5	907920-216  120x40x1029	PCS 1	908044-216  Ø33,7x679	PCS 2	908207-216  336x392x40	PCS 1	909256  Ø16/8.4x1.6	PCS 4
909511  90x90x650	PCS 13	909519  50x380x380	PCS 15	980114  Ø4x20	PCS 8	980123  Ø7x60	PCS 16	980131  Ø6x60	PCS 36	P00659 	PCS 1
	PCS		PCS		PCS		PCS		PCS		PCS
	PCS		PCS		PCS		PCS		PCS		PCS

— EN/AS Impact Area 21.6 m<sup>2</sup>  
+ + + + + + + + + +  
- - - - Falling Space 36.7 m<sup>2</sup>  
Max Falling Height 1000 mm

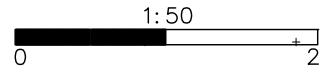

Grid size = 1000 mm

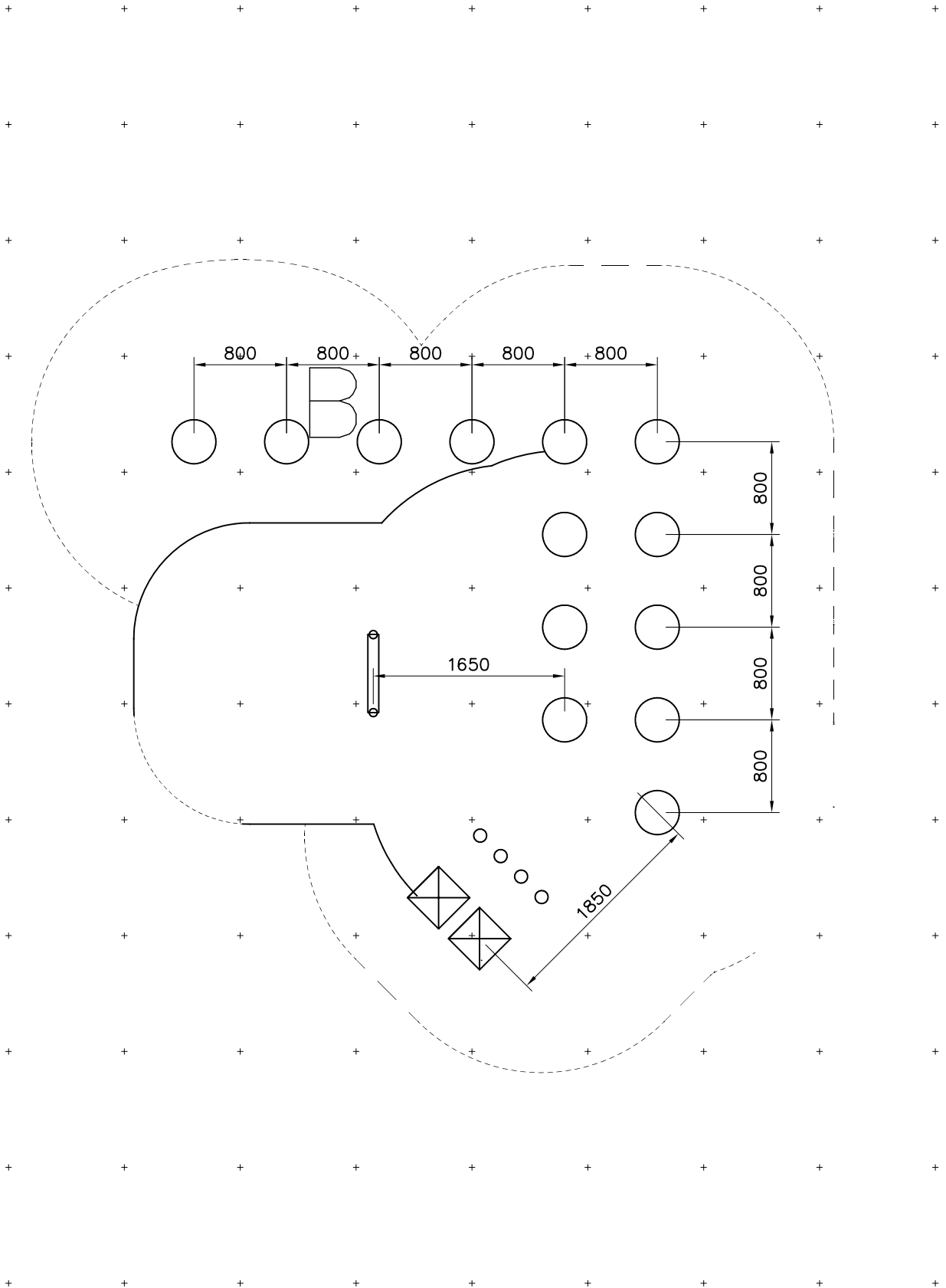

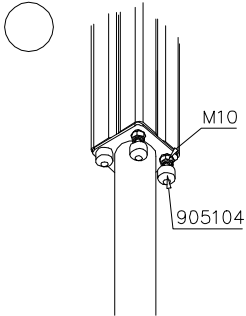
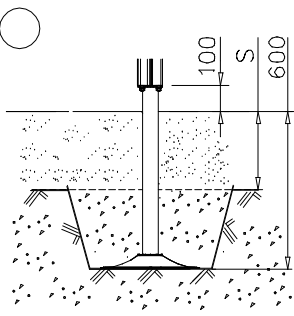
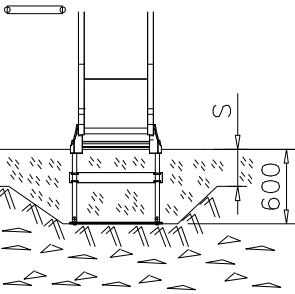
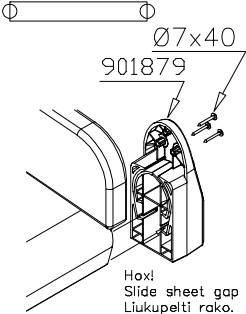
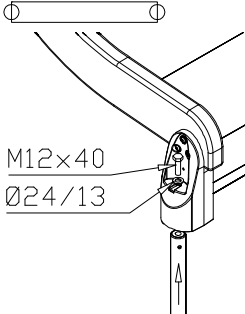
 <p>M10 905104</p>	 <p>100 S 600</p>	 <p>S 600</p>
 <p>Ø7x40 901879 Hox! Slide sheet gap Liukupelti rako.</p>	 <p>M12x40 Ø24/13</p>	

- EN/AS Impact Area 21.6 m<sup>2</sup>
- ==== Falling Space 36.7 m<sup>2</sup>  
Max Falling Height 1000 mm

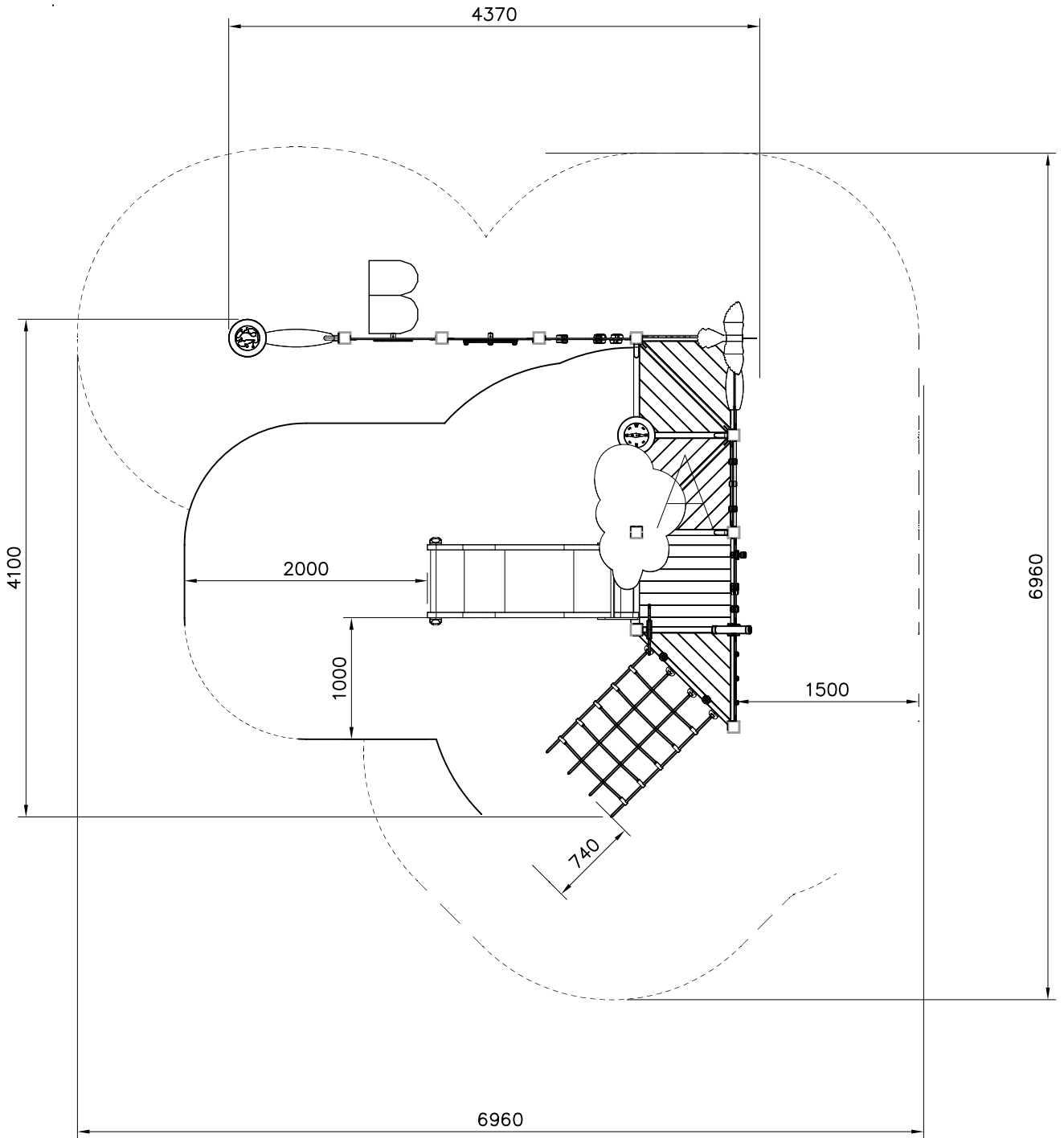
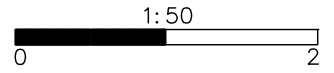

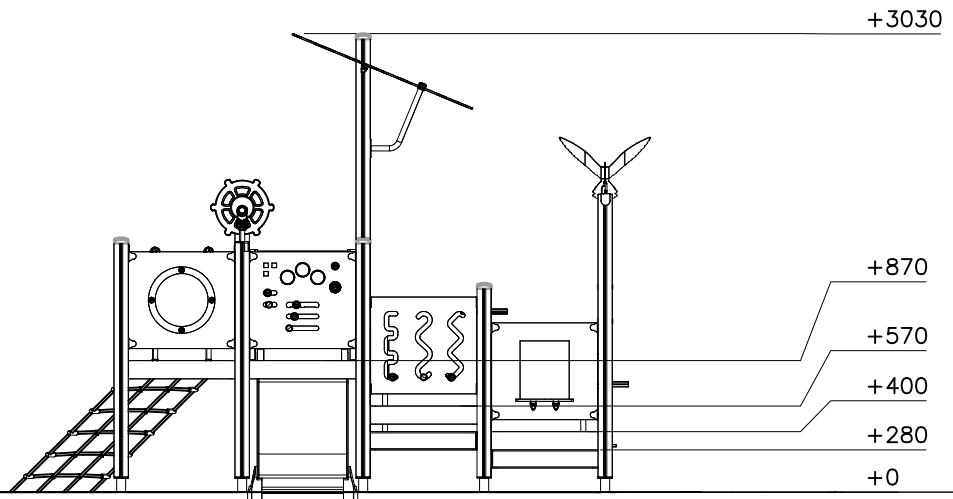
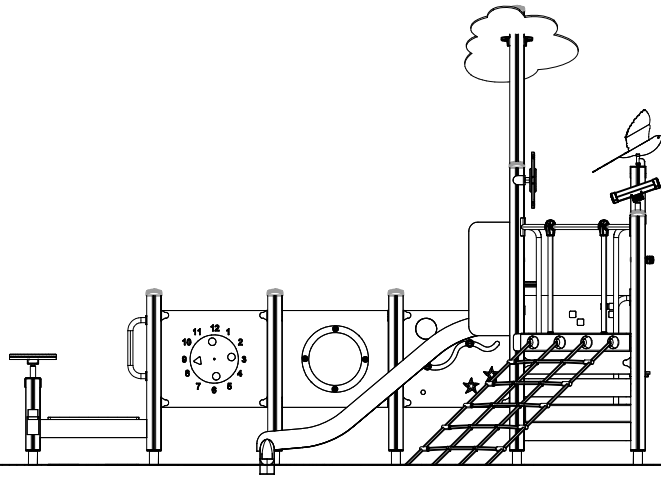

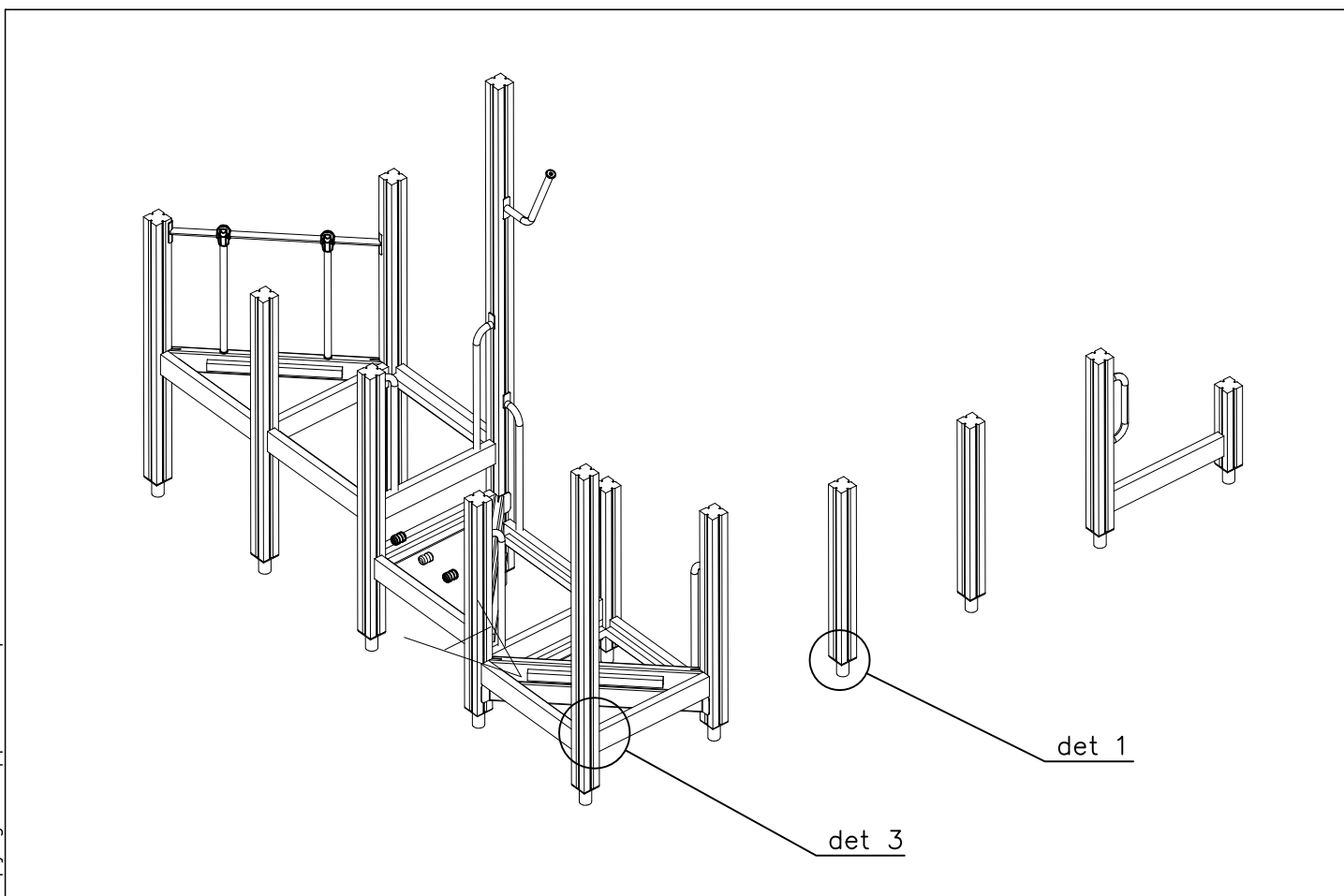
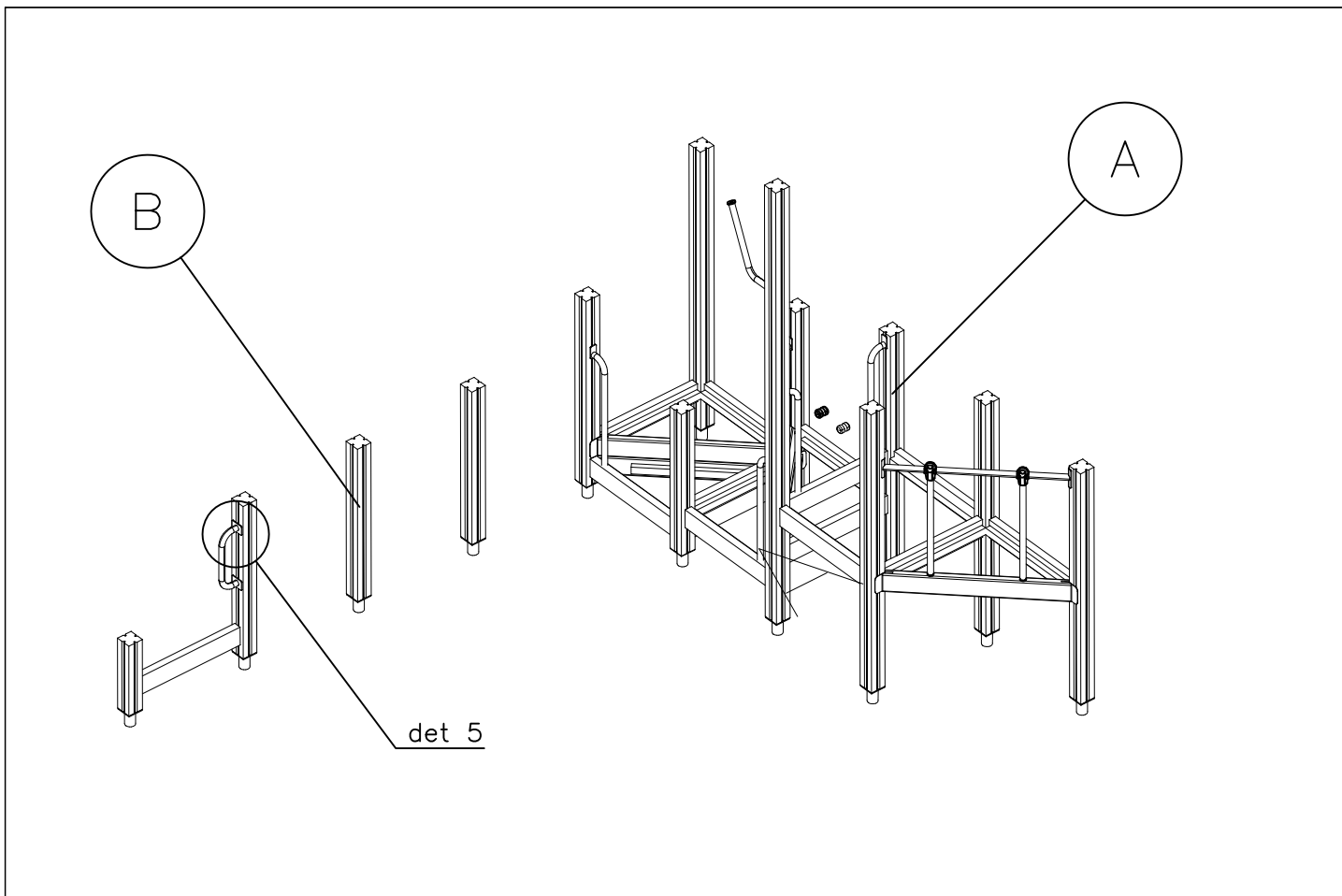

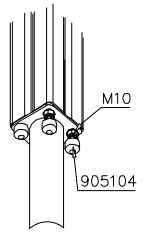
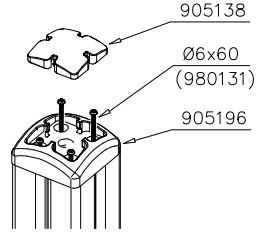
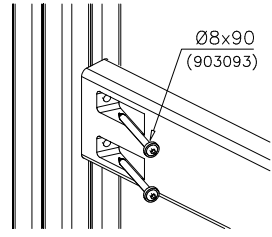
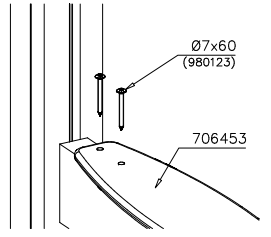
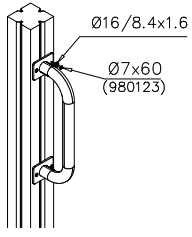

<p>DET 1</p> 	<p>DET 2</p> 	<p>DET 3</p> 	<p>DET 4</p> 
<p>DET 5</p> 	<p>DET 6</p>	<p>DET 7</p>	<p>DET 8</p>
<p>DET 9</p>			

DATE: 24.4.2017

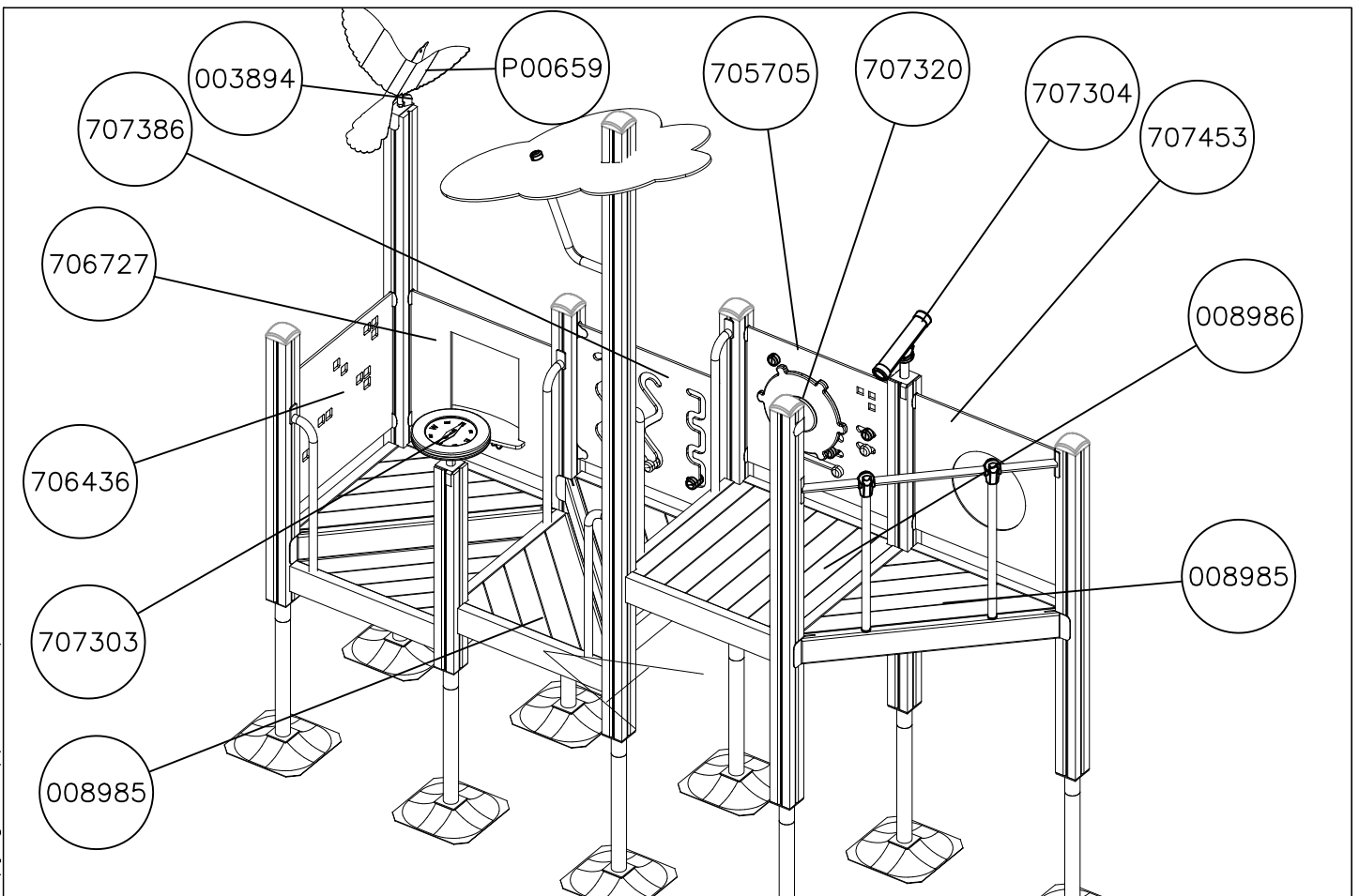
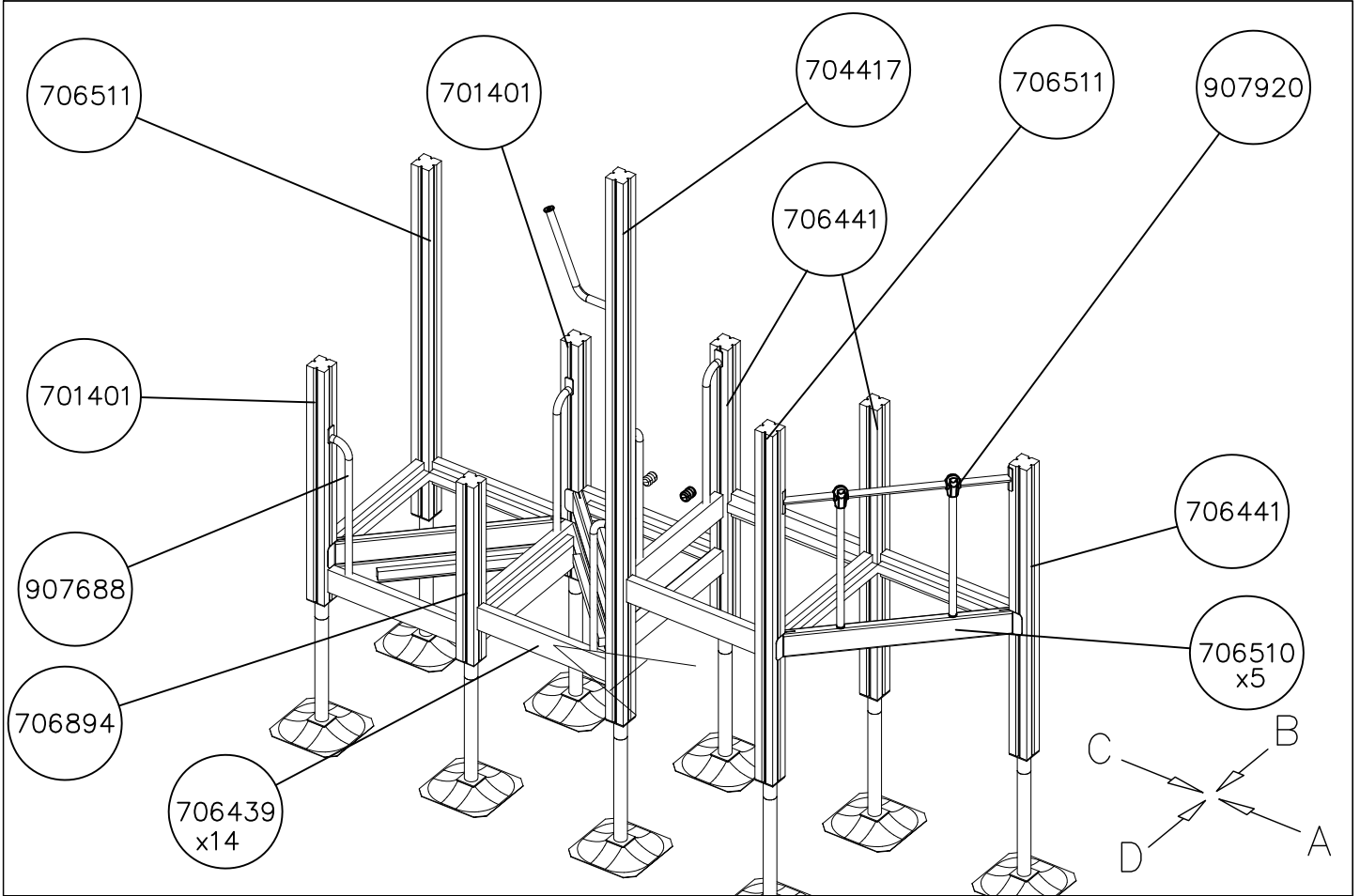

DATE: 24.4.2017

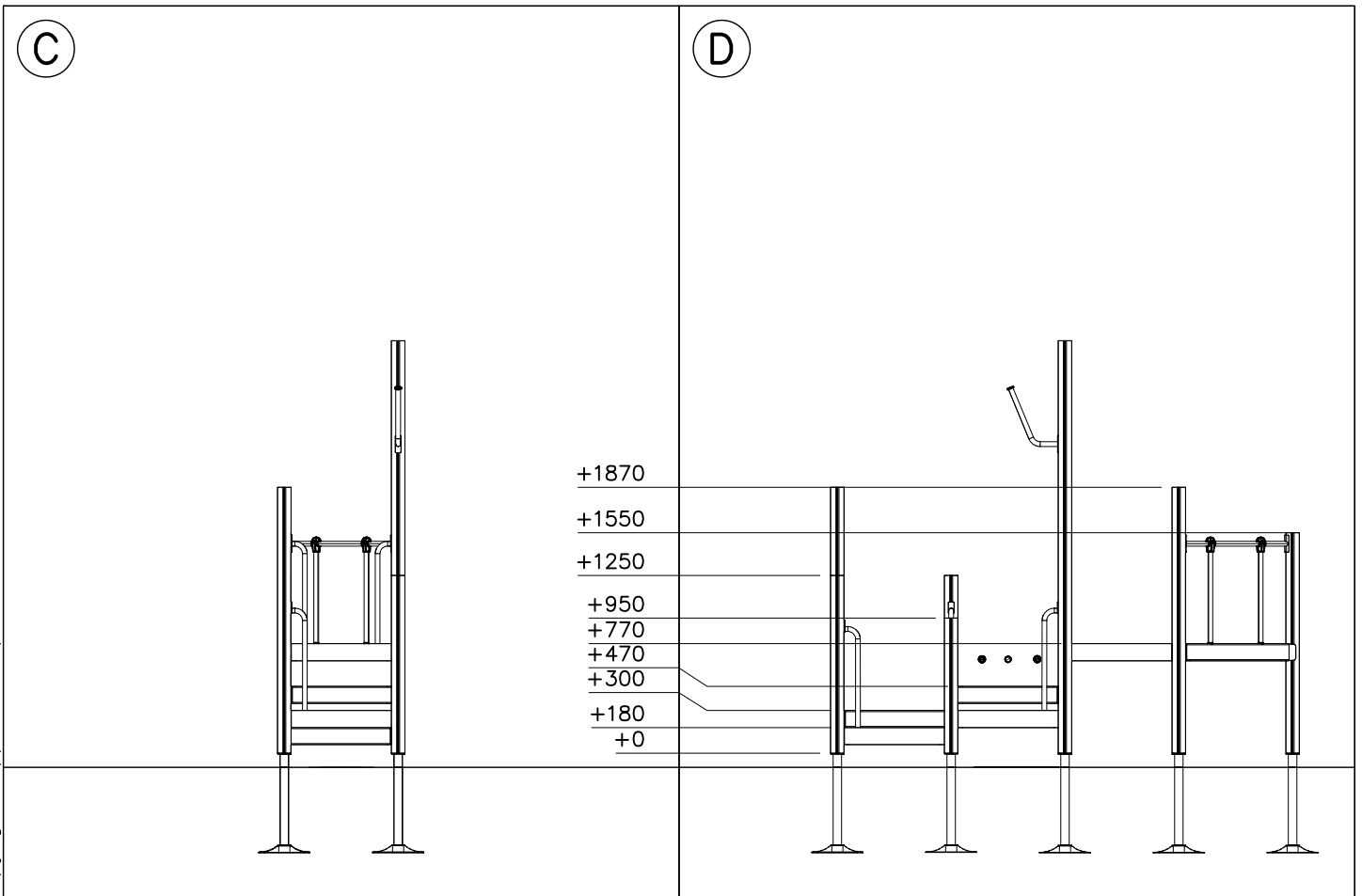
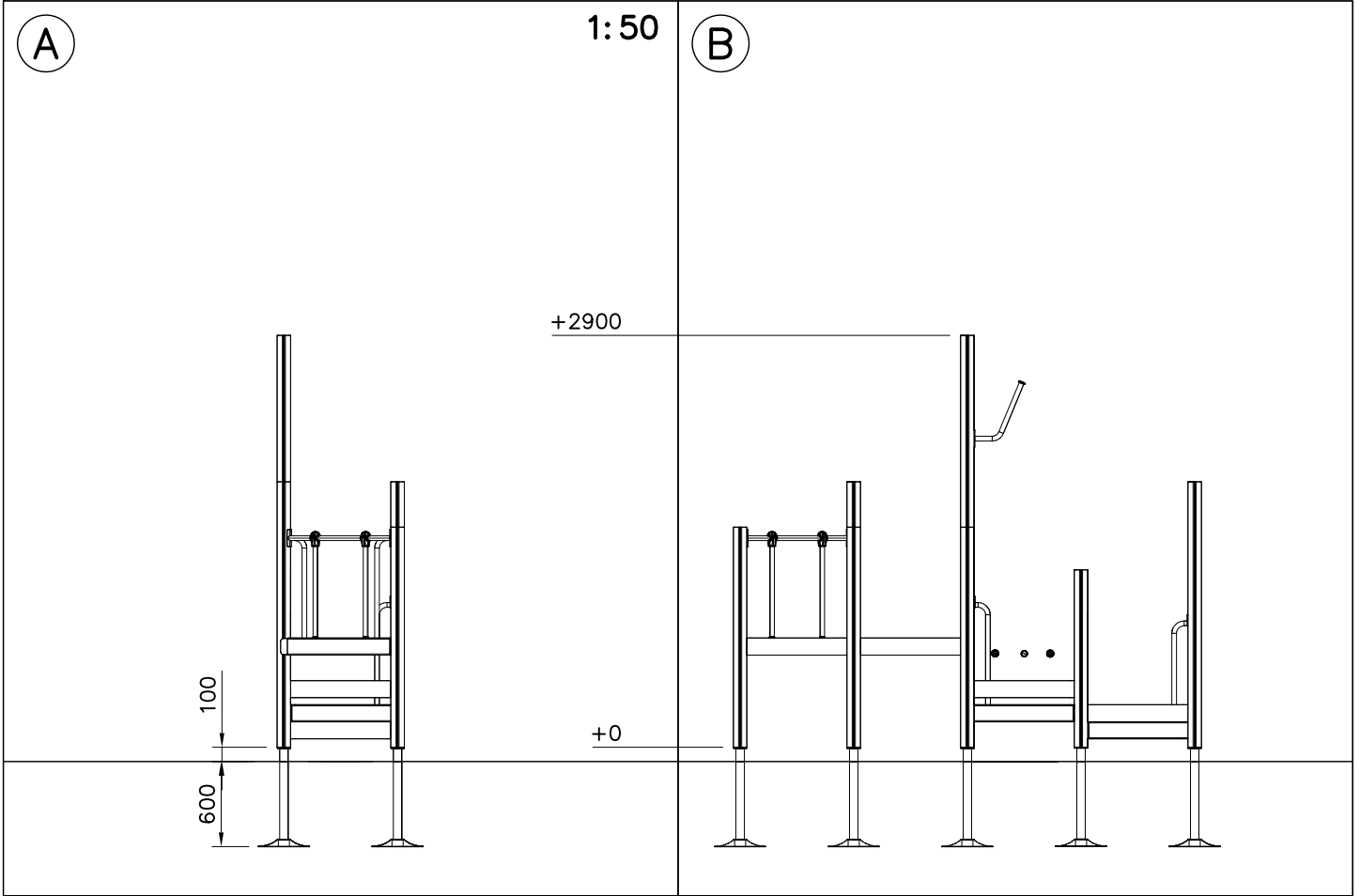

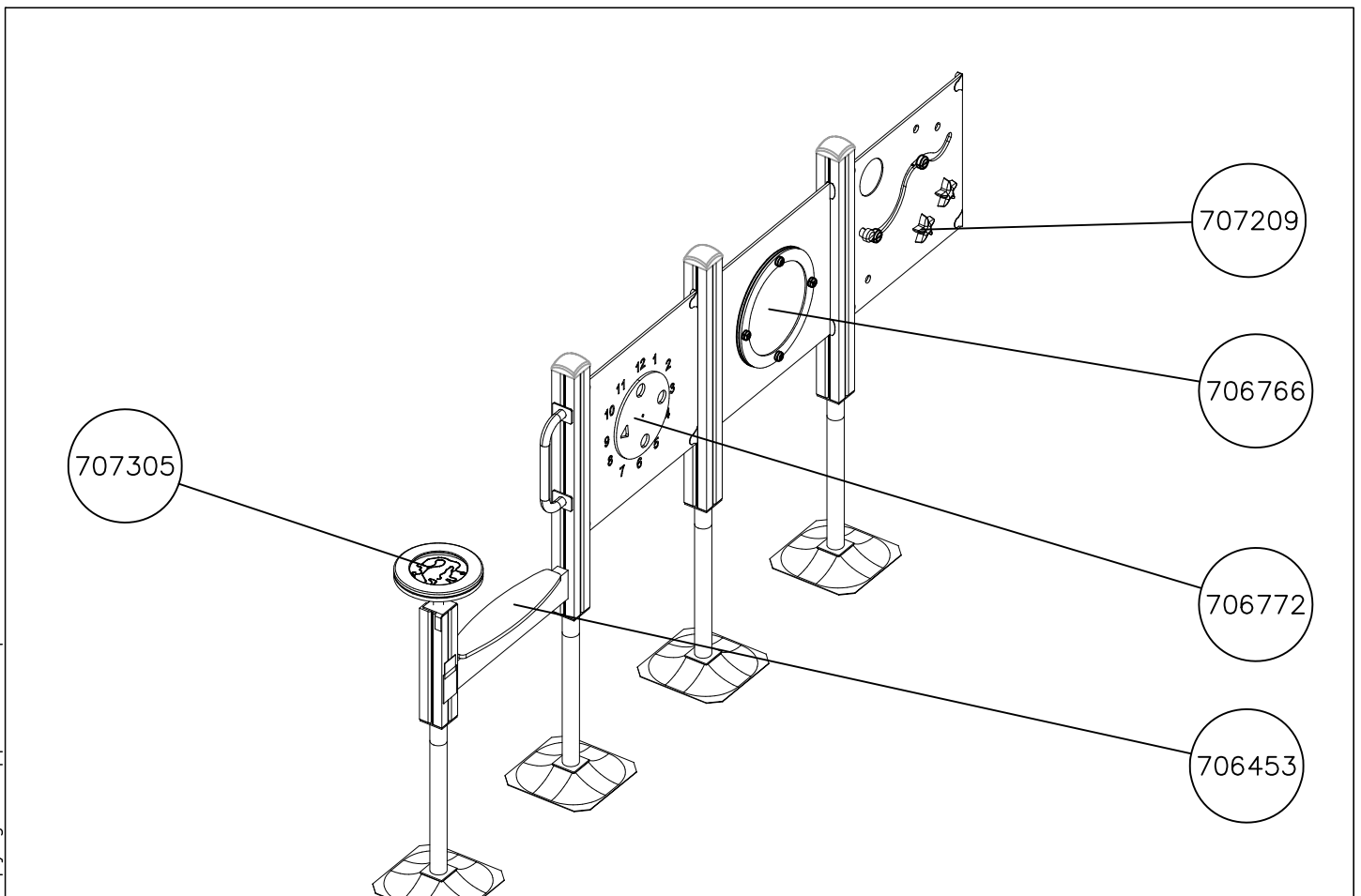
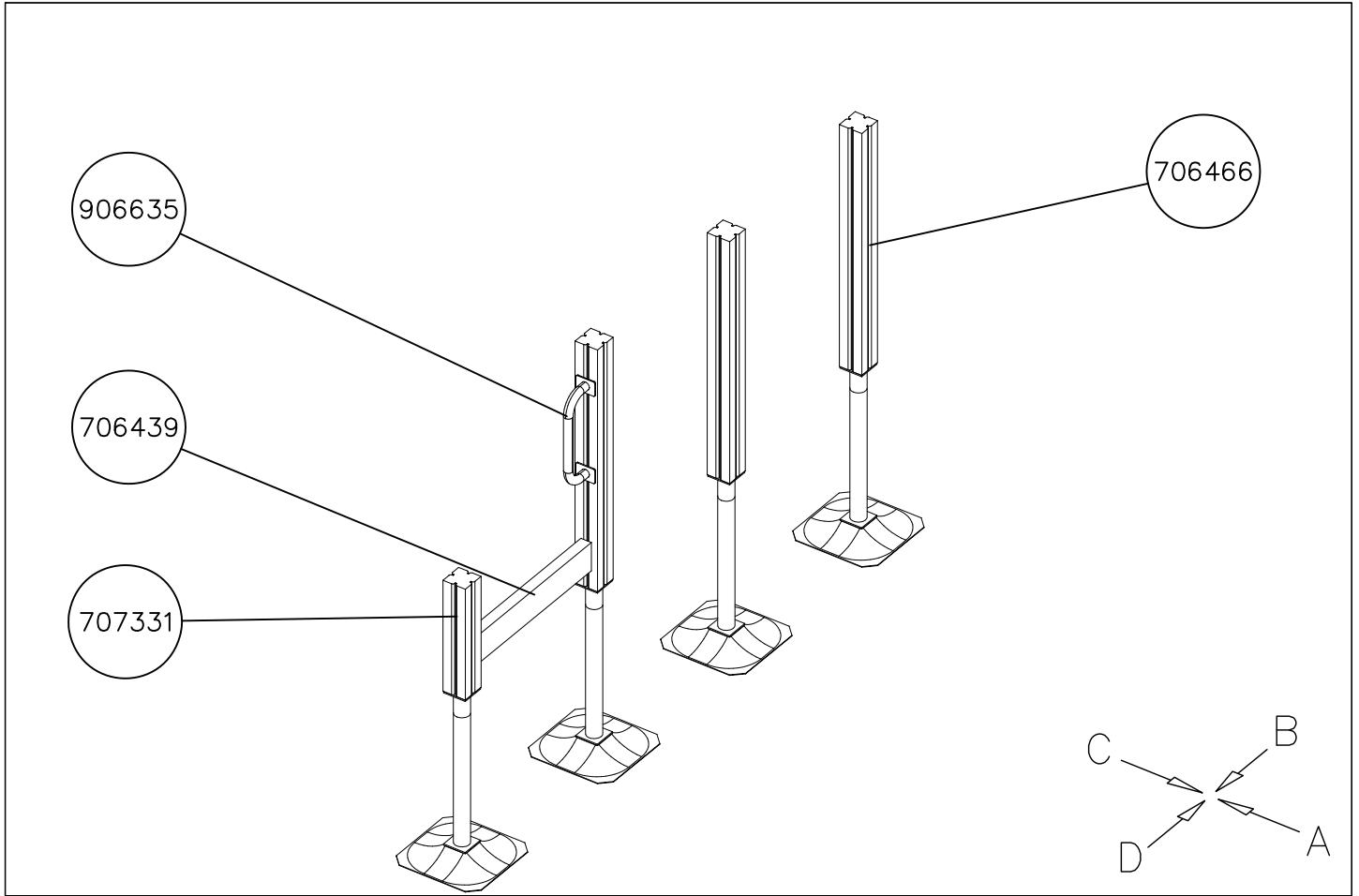

DATE: 24.4.2017

1:50

(A)

(B)

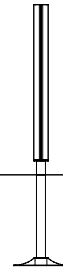
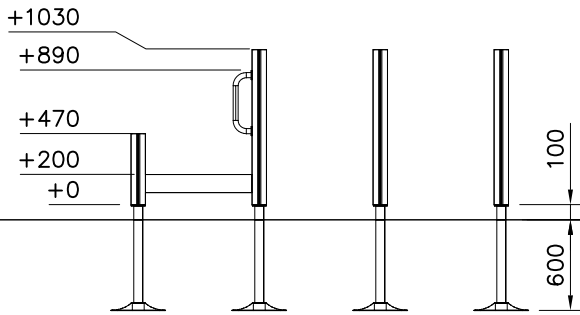

(C)

(D)

