

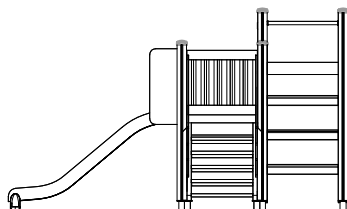

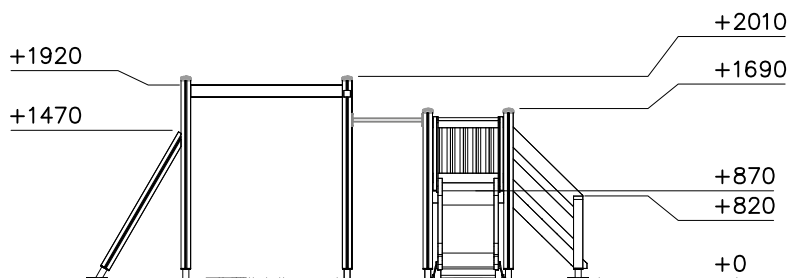

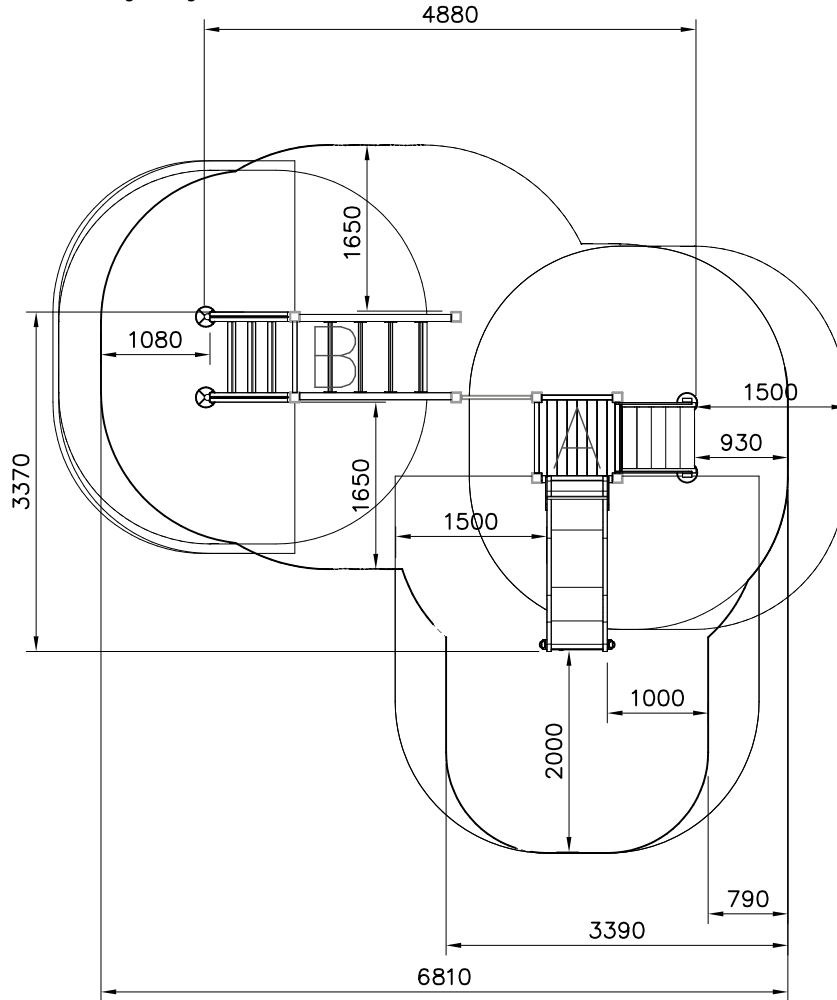

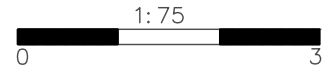



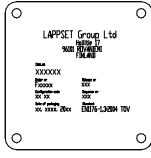
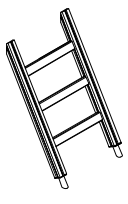

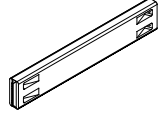

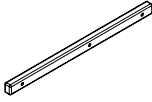
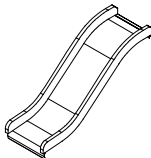

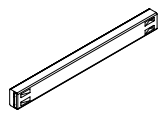
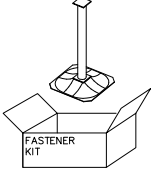
- EN/AS Impact Area 31.1 m²
 - AS4685:2004 Impact Area 35.1 m²
 - Falling Space 34 m²
- Max Falling Height 1920 mm

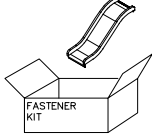
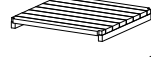
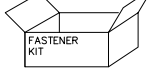
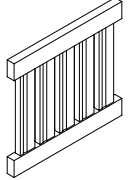
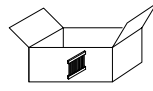
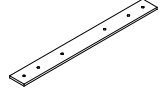
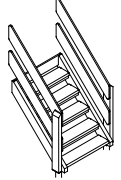

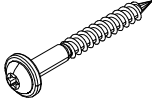
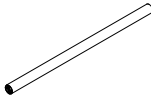
DATE: 29.2.2024

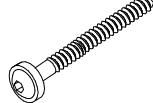
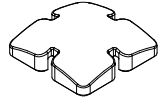
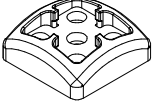
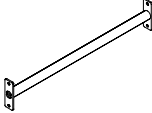
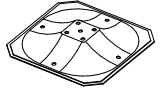
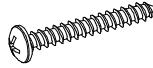
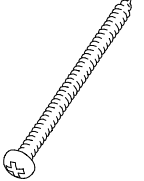
008986	PCS	702286	PCS	703130	PCS	706371-705	PCS	706439	PCS	706441	PCS
	1		1		1		2		5		4
750x750		65x65				15x345x750		L 704		93x93x1550	
706443	PCS	706452-604	PCS	706505	PCS	706511	PCS	706514	PCS	706531	PCS
	2		1		2		4		2		10
32x45x702		600x780x1470		35x70x730		93x93x1870		70x120x1504			
706533	PCS	706535	PCS	706746	PCS	706748	PCS	707133	PCS	707323	PCS
	1	 	1		2		2		1		1
				45x640x701				10x80x745			
900240	PCS	901868	PCS	901879	PCS	903093	PCS	905138	PCS	905196	PCS
	20		3		2		28		8		8
Ø8x70		Ø34x598				Ø8x90		GRAY		GRAY	
907694-216	PCS	909511	PCS	909519	PCS	980114	PCS	980131	PCS		PCS
	5		10		10		4		32		
L 704		90x90x650		50x380x380		Ø4x20		Ø6x60			
	PCS		PCS		PCS		PCS		PCS		PCS
	PCS		PCS		PCS		PCS		PCS		PCS