

LAPPSET®

FINNO







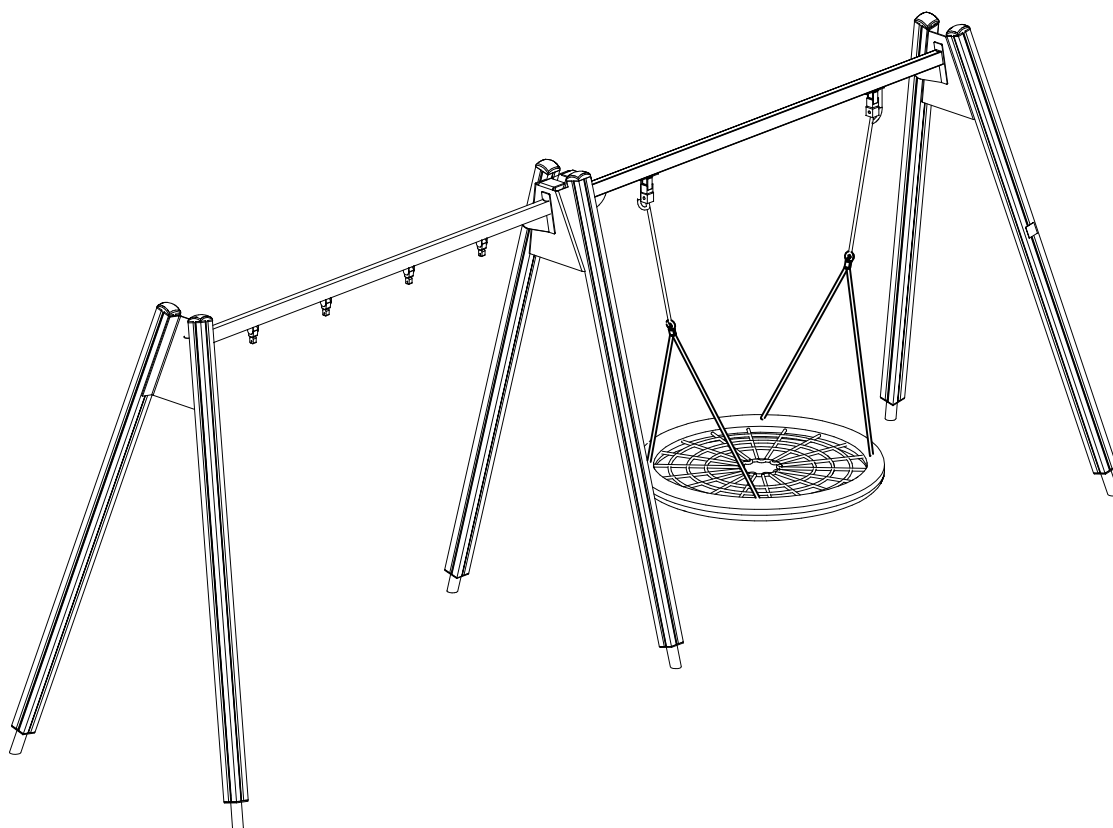



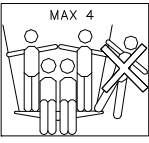



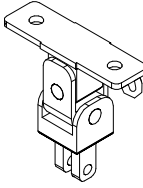

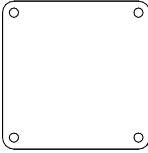

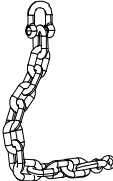
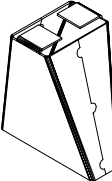
ASENNUSOHJE
MONTERINGSANSVISNING
INSTALLATION INSTRUCTION
AUFBAUANLEITUNG
NOTICE D'INSTALLATION

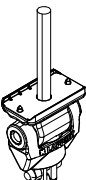
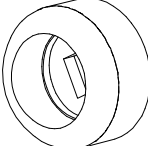
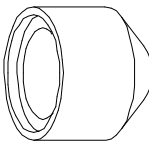
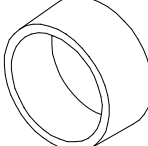
DATE: 4.8.2016

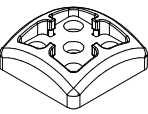
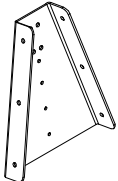
Q10144-1

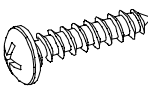
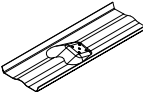
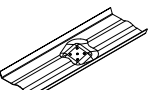

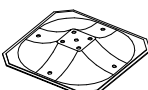
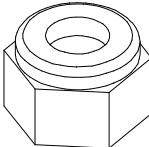
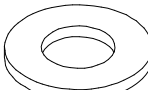
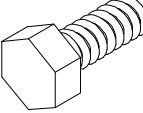
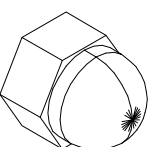
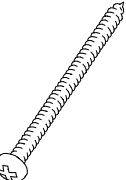
DATE: 4.8.2016

702286	PCS	702533	PCS	703248	PCS	706564	PCS	900965	PCS	901958	PCS
	1		1		1		6		8		2
90x50		90x50				L2650		M10			
901959	PCS	902234	PCS	902487	PCS	903149	PCS	903577	PCS	904317	PCS
	1		4		2		8		2		1
L2940		M12		65x65		M12x30					
904333	PCS	904904	PCS	905090	PCS	905104	PCS	905115	PCS	905138	PCS
	1		4		18		24		18		6
L2940				Ø45		M10		Ø30			
905196	PCS	905991	PCS	906499	PCS	909347	PCS	909506	PCS	909507	PCS
	6		2		4		18		8		2
				M12x110		M12x35		Ø3.5x13		L 1000	
909508	PCS	909511	PCS	909519	PCS	909637	PCS	909638	PCS	909639	PCS
	2		6		2		24		64		32
L 1000		L650		50x380x380		M10		Ø20/10.5		M10x25	
909644	PCS	980131	PCS	980154	PCS	999561	PCS		PCS		PCS
	8		24		42		1				
M12		Ø6x60		Ø24/13		10g					
	PCS		PCS		PCS		PCS		PCS		PCS

EN/AS Impact Area 43.1 m²

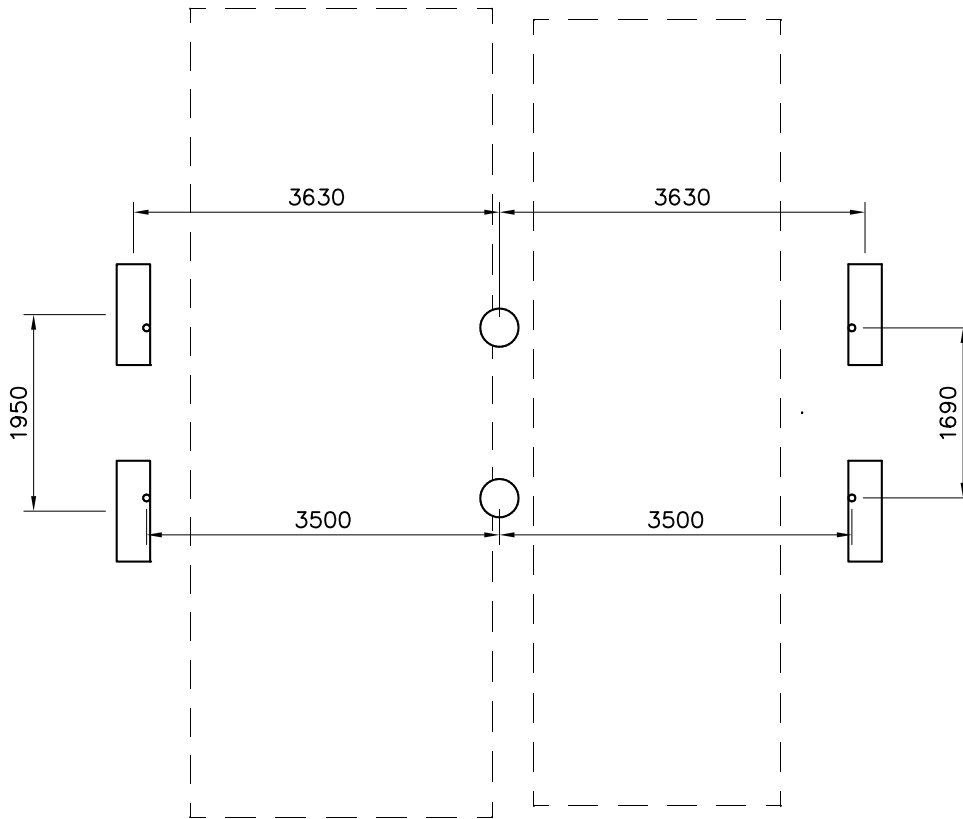
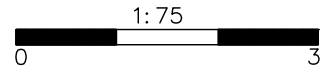

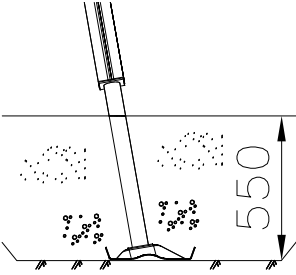
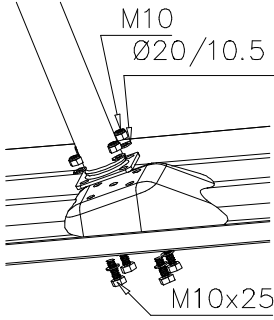
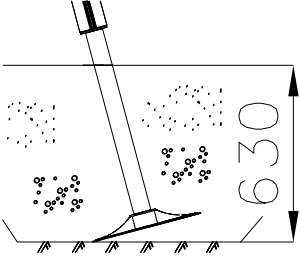
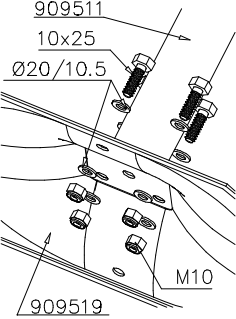
 <p>550</p>	 <p>M10 Ø20/10.5 M10x25</p>	 <p>630</p>
 <p>909511 10x25 Ø20/10.5 M10 909519</p>		

- EN/AS Impact Area 43.1 m²
- - - - Falling Space 43.1 m²
- Max Falling Height 1400 mm

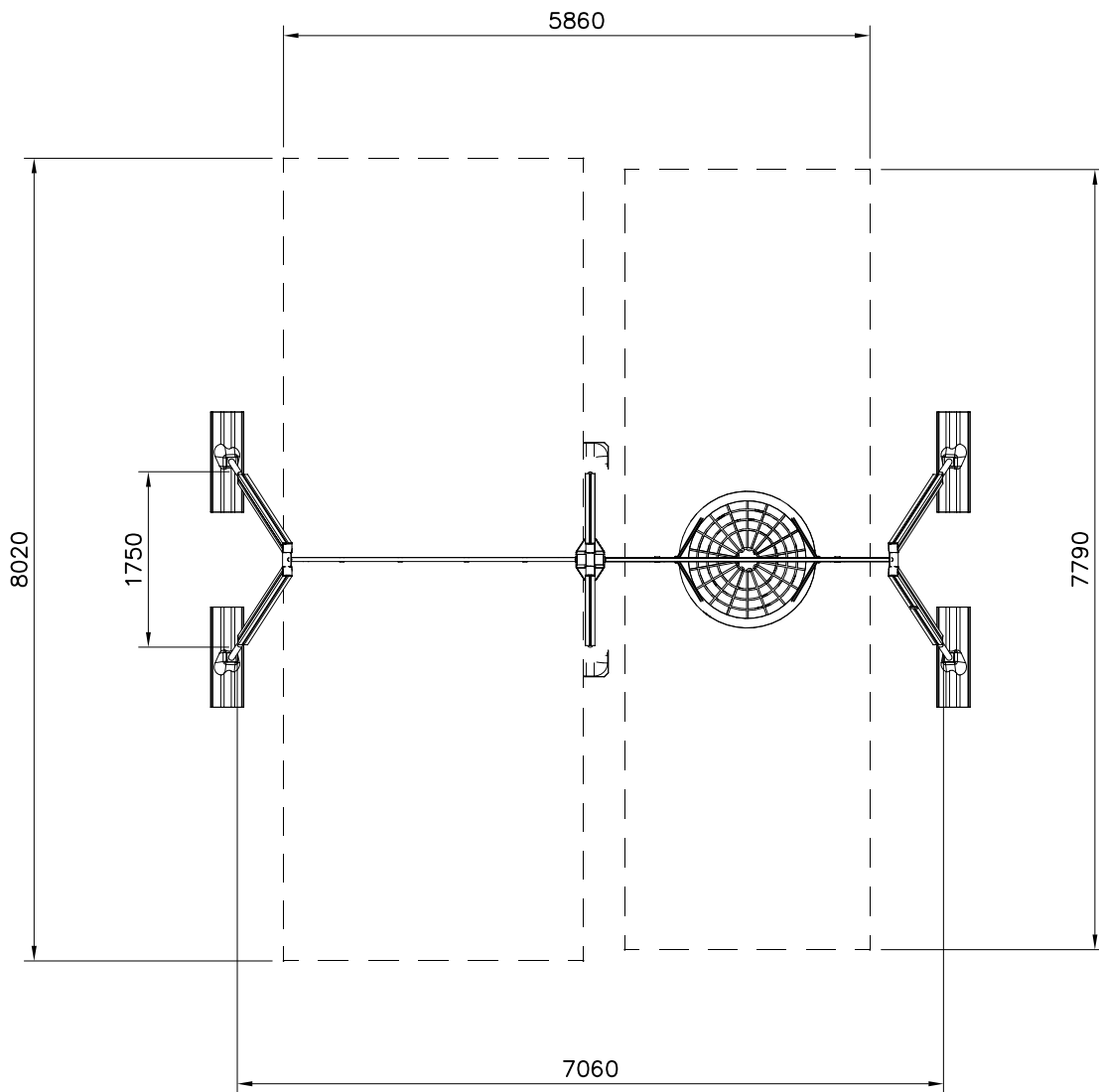
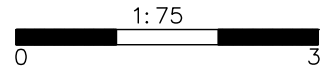

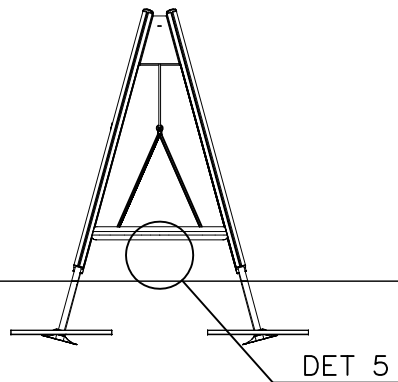
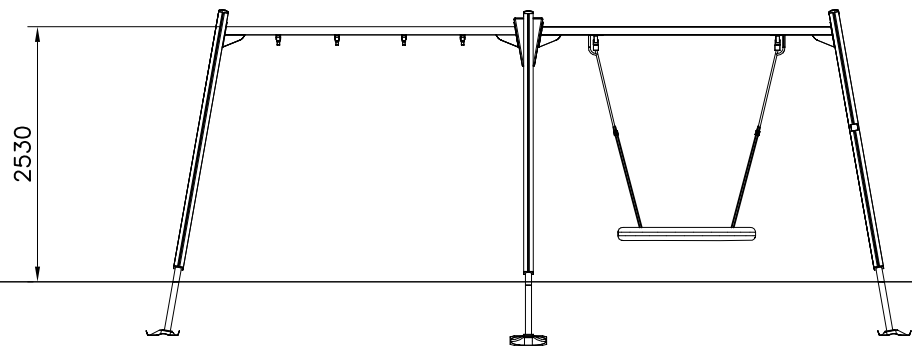

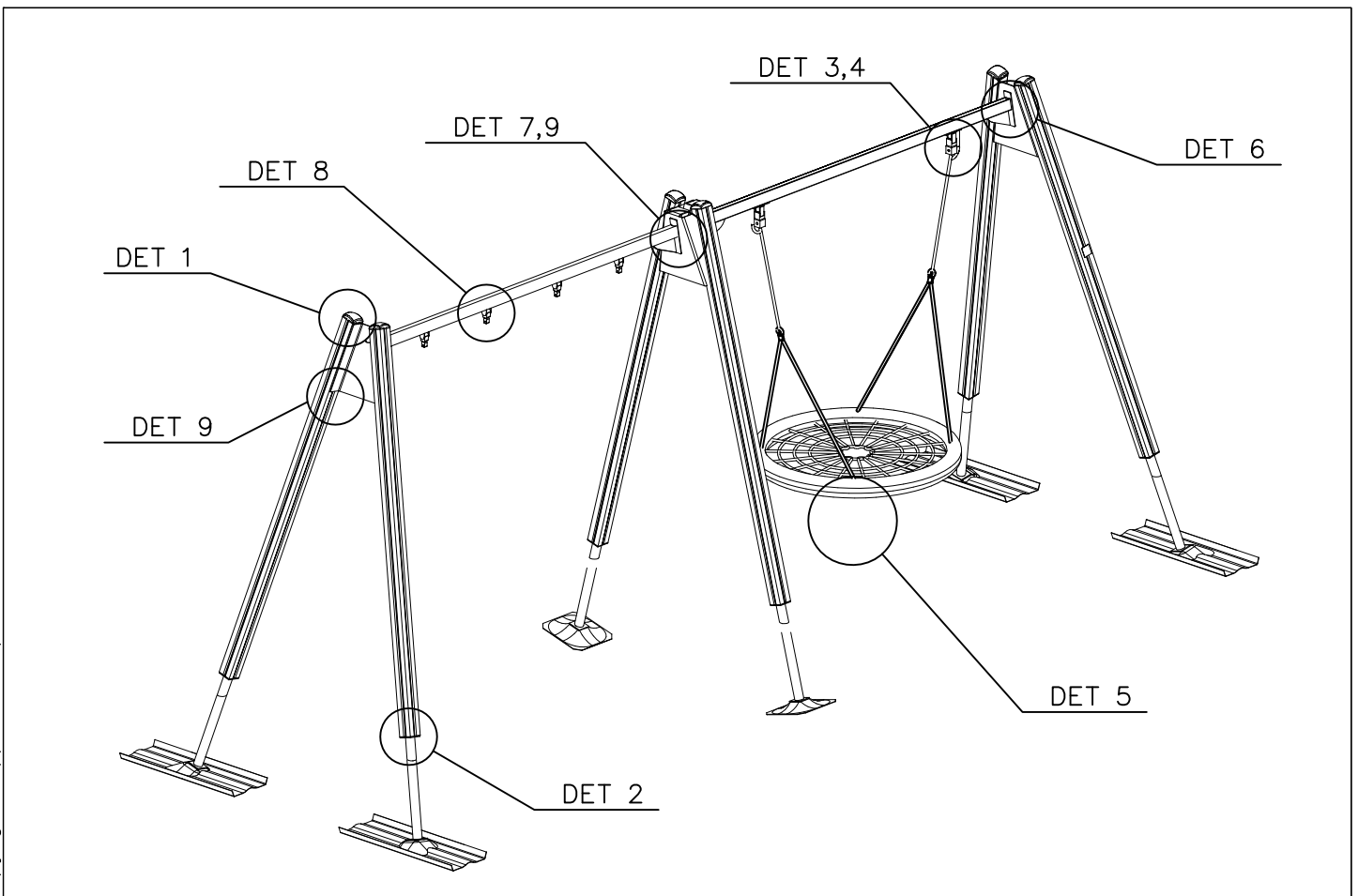
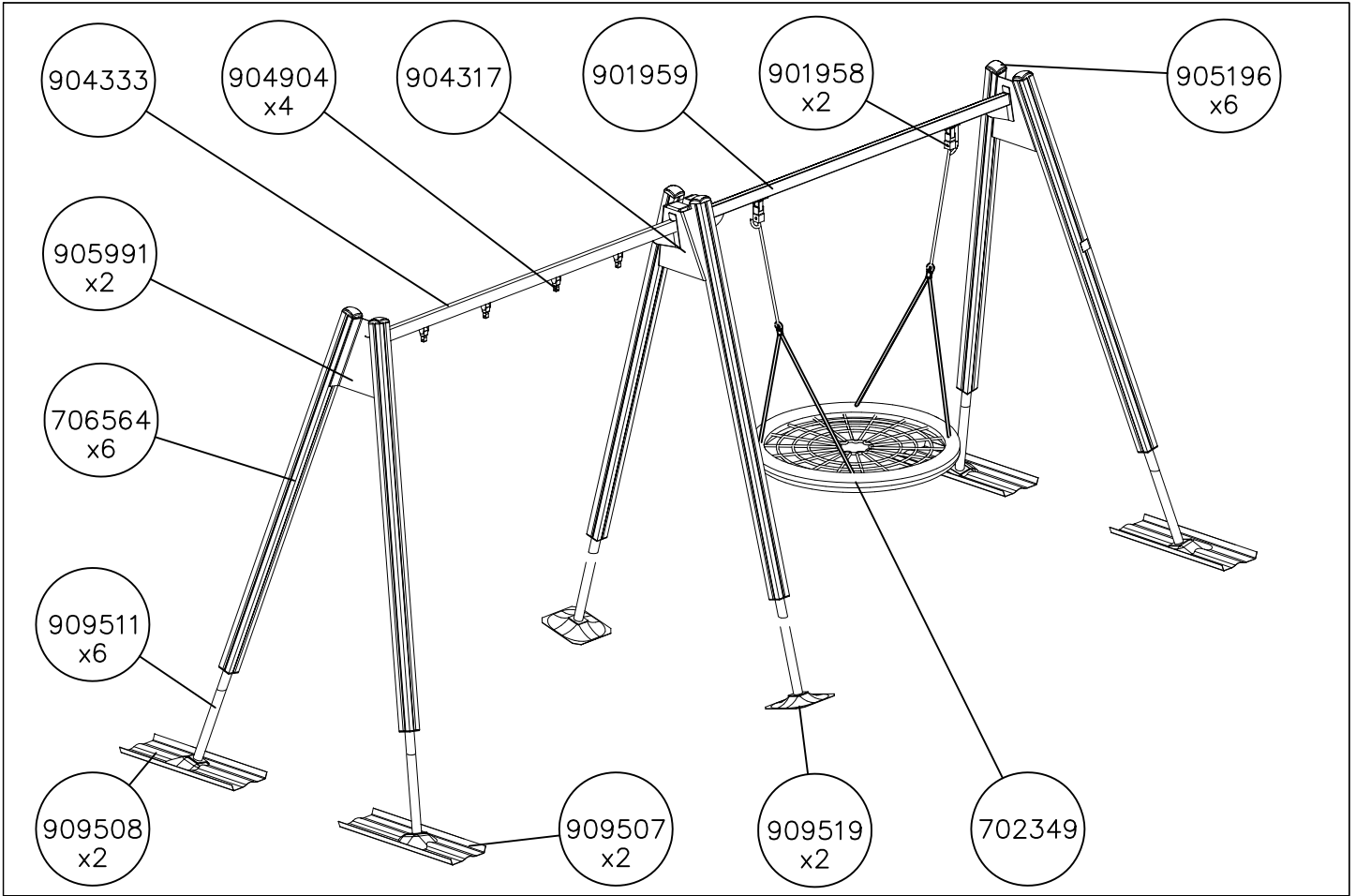

<p>DET 1</p> <p>6x60 980131</p>	<p>DET 2</p> <p>M10 905104 909521</p>	<p>DET 3</p> <p>901958 903577</p>	<p>DET 4</p> <p>M12x110 Ø24/13 901958 Ø24/13 M8x35 M12 M8 CUT EXTRA CHAIN</p>
<p>DET 5</p> <p>>400</p>	<p>DET 6</p> <p>M12 → 80 Nm Ø24/13 M12 M12x30 M10x25 Ø20/10.5 M10 → 45 Nm</p>	<p>DET 7</p> <p>904317</p>	<p>DET 8</p> <p>M12 980154 Ø24/13 904904</p>
<p>DET 9</p> <p>999561 GLUE Ø24/13 12x35 905115 905090</p>			

