

LAPPSET®

FINNO









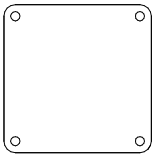

ASENNUSOHJE
MONTERINGSANSVISNING
INSTALLATION INSTRUCTION
AUFBAUANLEITUNG
NOTICE D'INSTALLATION

DATE: 7.6.2016

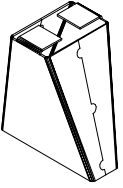
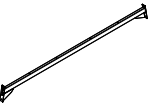
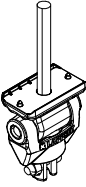
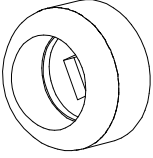
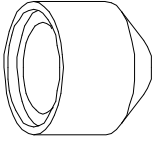
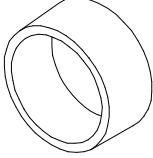
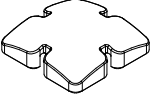
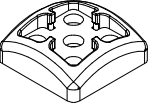
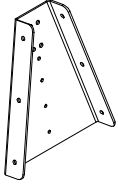
Q10027

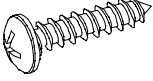
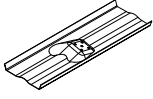
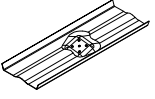

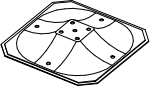
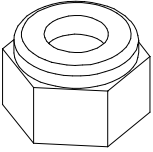
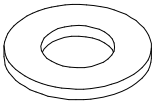
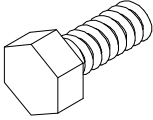
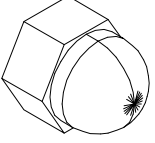
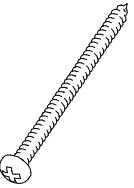
DATE: 7.6.2016

702286  90x50	PCS 1	706564-602  L2650	PCS 6	900965  M10	PCS 8	902487  65x65	PCS 1	903149  M12x30	PCS 8	904317  1	PCS 1
904333  L2940	PCS 2	904904  904904	PCS 8	905090  Ø45	PCS 18	905104  M10	PCS 24	905115  Ø30	PCS 18	905138  6	PCS 6
905196  905196	PCS 6	905991  905991	PCS 2	909347  M12x35	PCS 18	909506  Ø3.5x13	PCS 4	909507  L 1000	PCS 2	909508  L 1000	PCS 2
909511  L650	PCS 6	909519  50x380x380	PCS 2	909637  M10	PCS 24	909638  Ø20/10.5	PCS 64	909639  M10x25	PCS 32	909644  M12	PCS 8
980131  Ø6x60	PCS 24	980154  Ø24x13	PCS 34	999561  10g	PCS 1		PCS		PCS		PCS
	PCS		PCS		PCS		PCS		PCS		PCS
	PCS		PCS		PCS		PCS		PCS		PCS

- EN/AS Impact Area 48.1 m²
- - - - Falling Space 48.1 m²
- Grid size = 1000mm

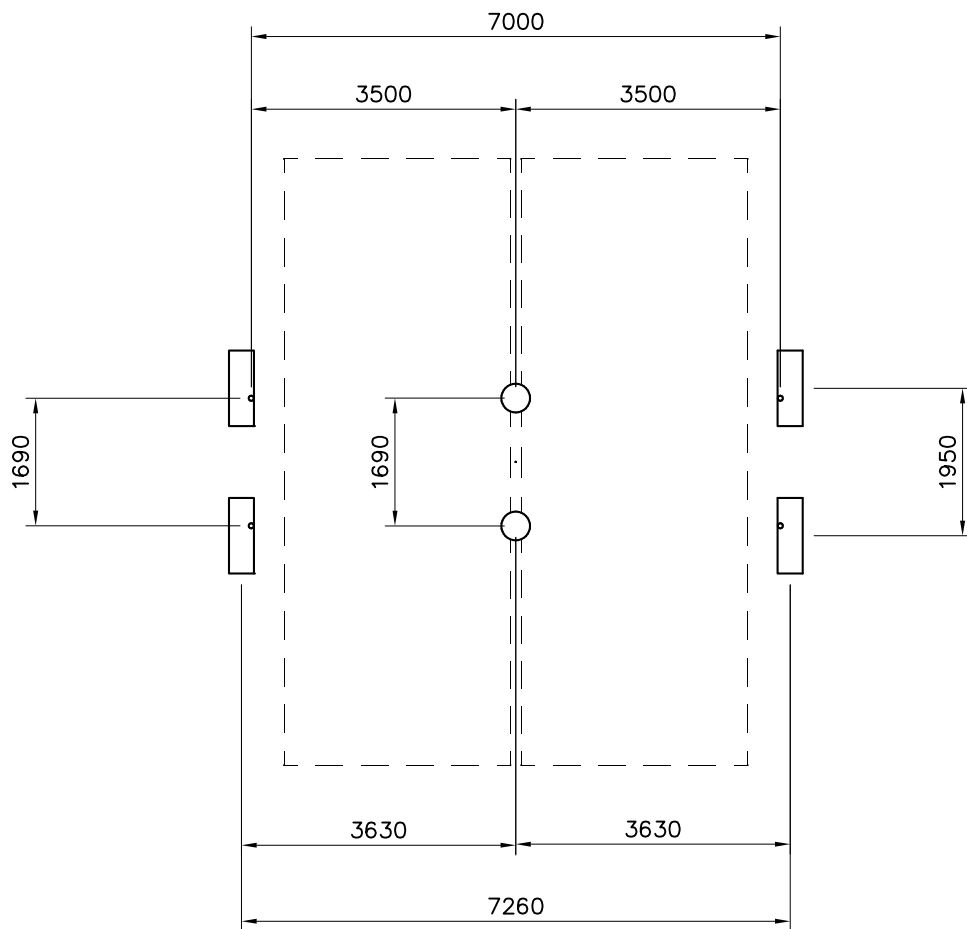
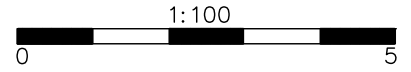

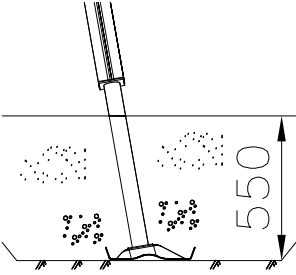
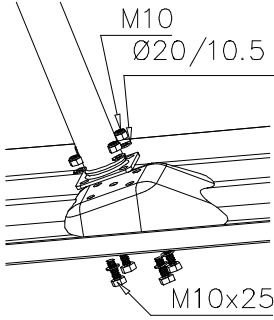
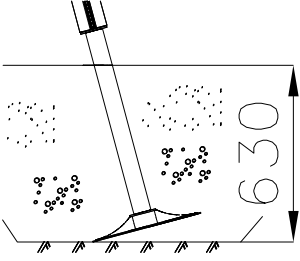
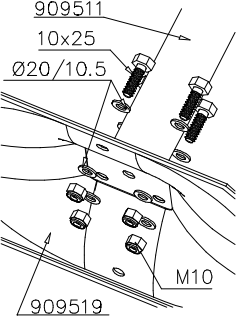

- EN/AS Impact Area 48.1 m²
- - - - Falling Space 48.1 m²
Max Falling Height 1400 mm

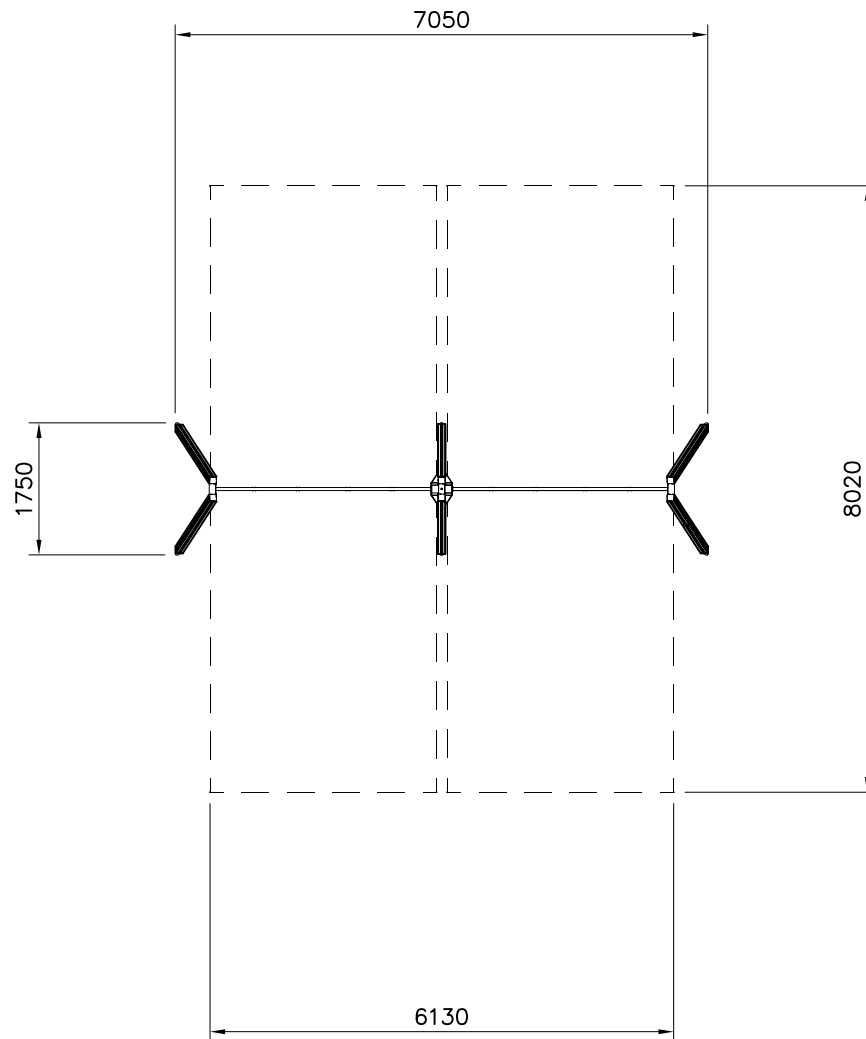
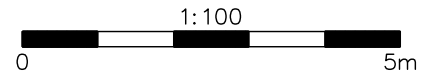

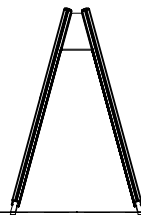
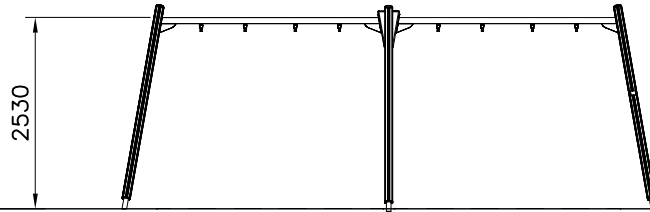

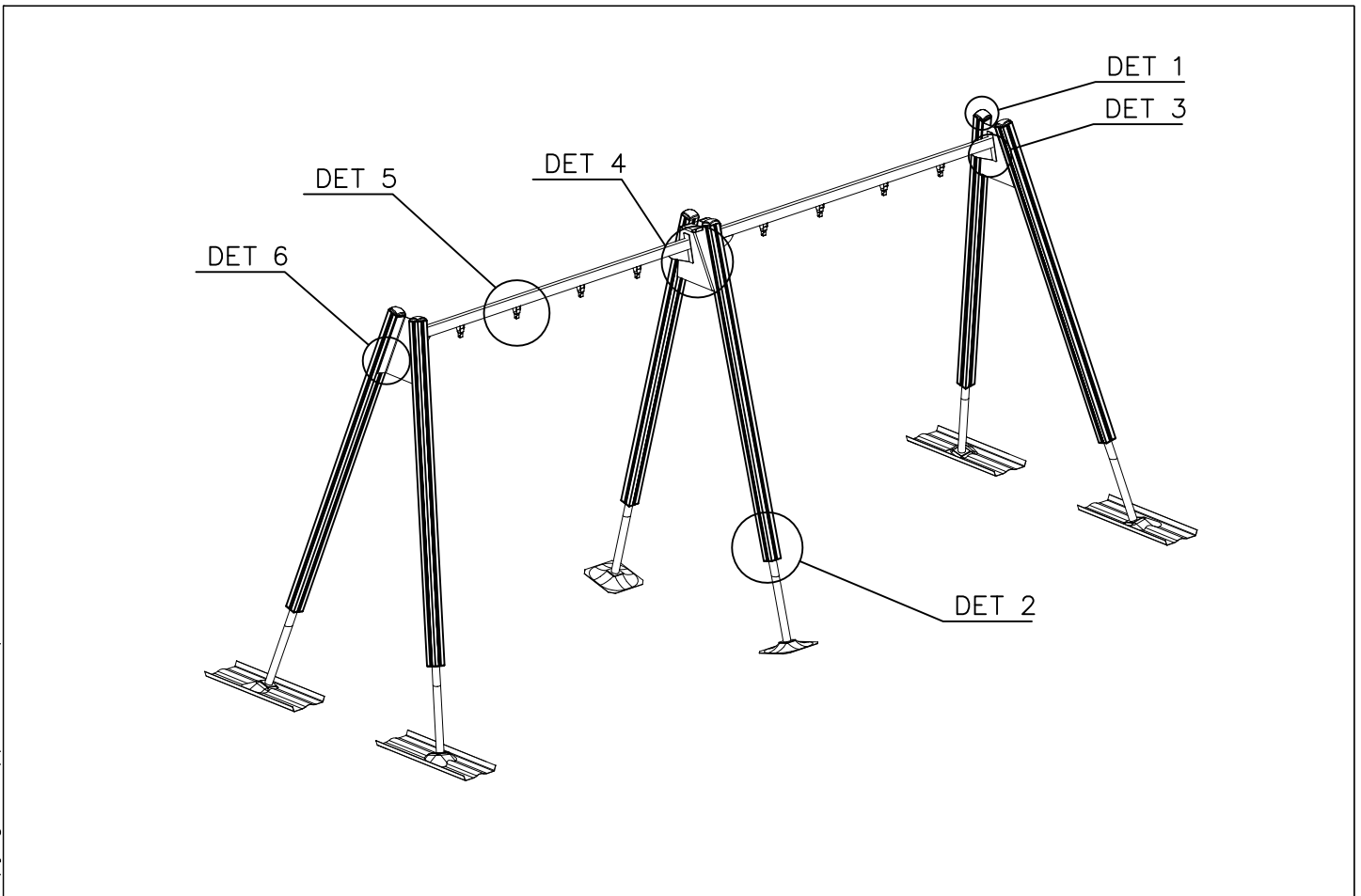
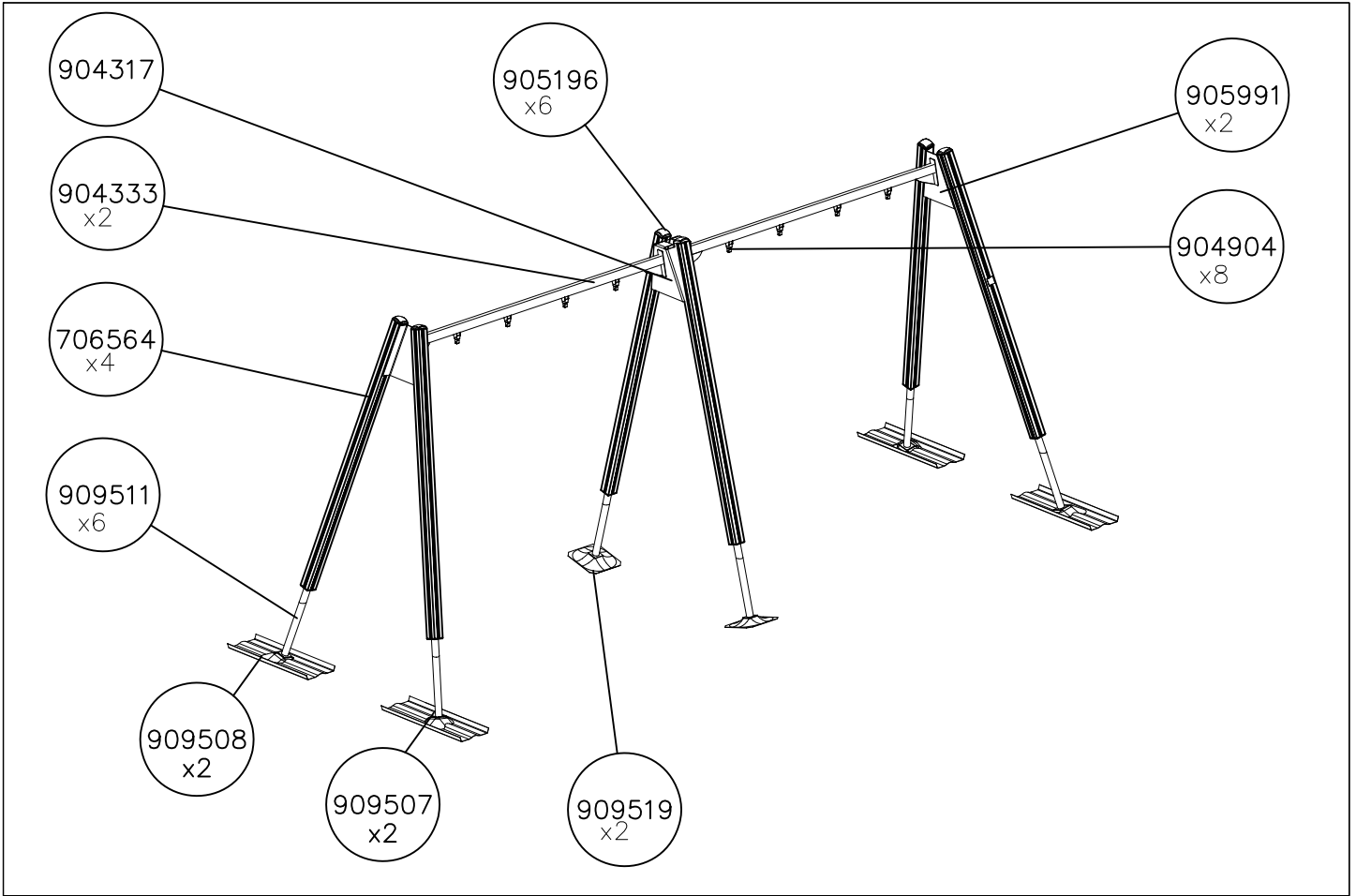

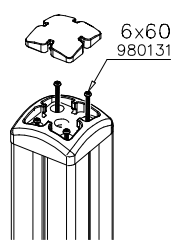
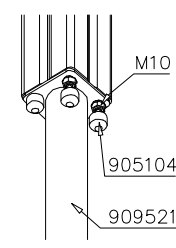
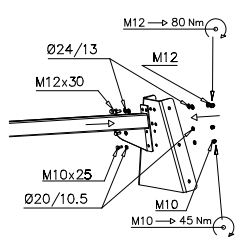
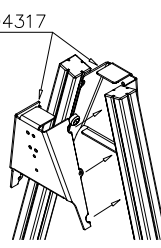
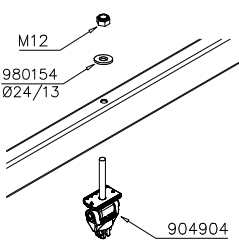
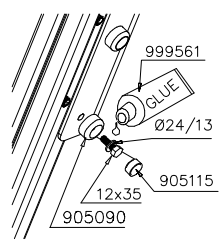
<p>DET 1</p>  <p>6x60 980131</p>	<p>DET 2</p>  <p>M10 905104 909521</p>	<p>DET 3</p>  <p>M12 → 80 Nm Ø24/13 M12x30 M12 M10x25 Ø20/10.5 M10 → 45 Nm</p>	<p>DET 4</p>  <p>904317</p>
<p>DET 5</p>  <p>M12 980154 Ø24/13 904904</p>	<p>DET 6</p>  <p>999561 GLUE Ø24/13 905115 12x35 905090</p>		



		
<p>$h < 600$</p> <p>Without movement and therefore without Impact Area</p>	<p>Totally hard surfaces.</p> <p>Note. Lappset does <u>not recommend</u> totally hard surfaces at all.</p>	<p>E.g. concrete or asphalt</p> 
<p>$h < 600$</p> <p>With movement e.g. rocking</p>	<p>Materials with very limited impact attenuating properties.</p>	<p>E.g. wood</p> 
<p>$h < 1000$</p>	<p>Materials with significant impact attenuating properties.</p>	<p>fine gravel 0–8 mm</p>  <p>grass</p>  <p>unsorted sand</p> 
<p>$h < 3000$</p>	<p>Loose fill material</p> <p>E.g. sand/gravel 0,25...8 mm D60/D10<3,0 Woodchips 5...30 mm bark 20...80 mm</p>	 <p>\underline{S} \underline{h}</p> <p>30 cm < 2,0 m</p> <p>40 cm < 3,0 m</p>
	<p>Syntethic granulates</p> <p>\underline{S} \underline{h}</p> <p>40 mm ~> 1,2...1,3 m</p> <p>50 mm ~> 1,5...1,7 m</p> <p>60 mm ~> 1,8...2,0 m</p> <p>70 mm ~> 2,1...2,5 m</p> <p>Note. For accurate values, see manufacturer's instructions.</p>	

REMOVE SAFETY SURFACE/SAND/GRAVEL
TO CHECK FOUNDATION



REMOVE SAFETY SURFACE/SAND/GRAVEL
TO CHECK FOUNDATION



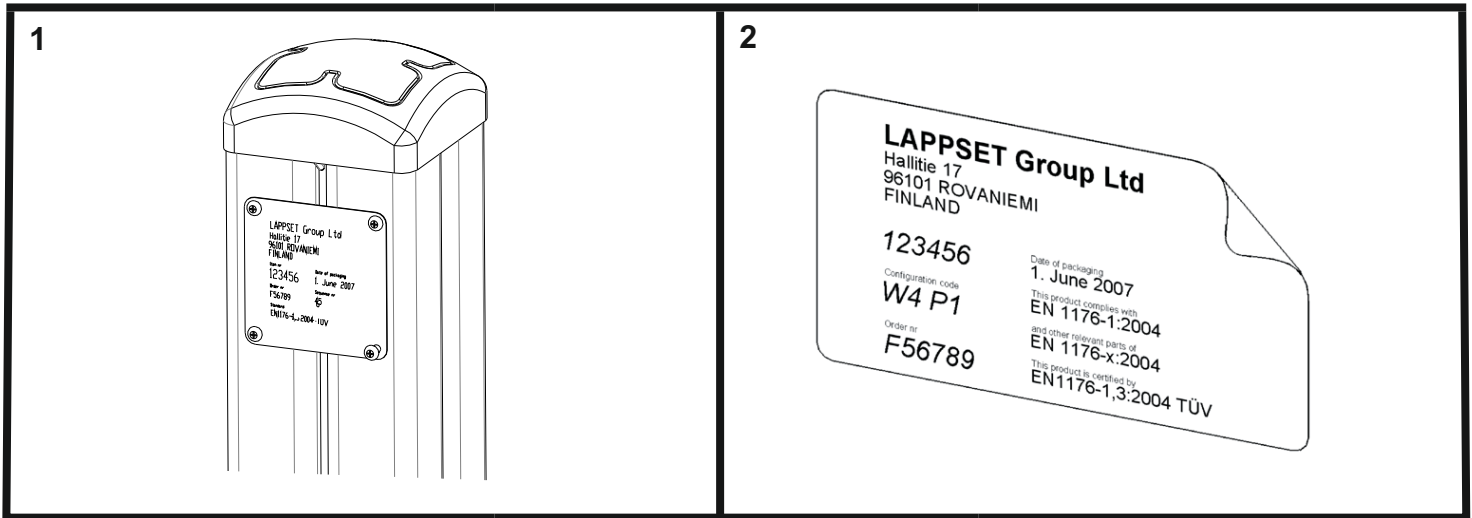

Tuotekyltti tulee tuotteen mukana yhdellä seuraavista tavoista:

1) Metallinen tuotekyltti ja kiinnitysruuvit

- Kiinnitä tuotekyltti ruuveilla tolppaan noin 2 metrin korkeuteen kuvan 2 mukaisesti.

2) Tuotekylttitarra

- Puhdista maalattu metalli- tai vaneripinta pölystä ja kosteudesta. Liimaa tarra kuvan 3 mukaisesti.
- Huom. Älä kiinnitä tarraa karheapintaiseen laminaattiin tai maalattuun puuhun.

Vår produktmärkning levereras på ett av följande sätt:

1) Produktskylt i metall

- Fäst skylten med de medföljande skruvarna

2) Självhäftande produktetikett

- Rengördenpulverlackerademetallytanellerlaminatytansåattdenblirfrifrånsmutsochfukt.Fästetikettenenligtfig.3.
- Obs! Fäst ej etiketten på detaljer med skrovlig yta eller på målat trä.

Product label is delivered by one of following ways:

1) Metal product label and screws

- Fasten the label with screws.

2) Label sticker

- Cleanthepaintedmetalorplywoodsurfacefromdirtandmoisture.Fastenthestickerasshowninthefigure3.
- Note. Do not attach the sticker to rough surfaced laminate or painted wood.

La plaque d'informations produit est livrée sous l'une de ces 3 formes :

1) Plaque métallique et vis

- Fixez la plaque à l'aide des vis.

2) Etiquette autocollante

- Avant de coller l'étiquette, nettoyez le composant métallique peint ou la plaque de contreplaqué, de toute saleté. La surface doit être sèche (voir image 3).
- Attention, ne pas coller l'étiquette sur une surface lamellé-collée irrégulière ou sur du bois peint.

Die Auslieferung des Produktaufklebers erfolgt auf eine dieser Arten:

1) Produkt-Schild aus Metall incl. Schrauben

- Die Befestigung des Schildes erfolgt mittels der Schrauben.

2) Aufkleber

- EntfernenSiezunächstSchmutzundFeuchtigkeitvomlackiertenMetallbzw.vonderHolzoberflächeundbringenSiedenAufkleber wie im Bild oben rechts beschrieben auf den gesäuberten Untergrund auf.
- Beachten Sie: Bringen Sie den Aufkleber nicht auf raues laminiertes oder lackiertes Holz an.