

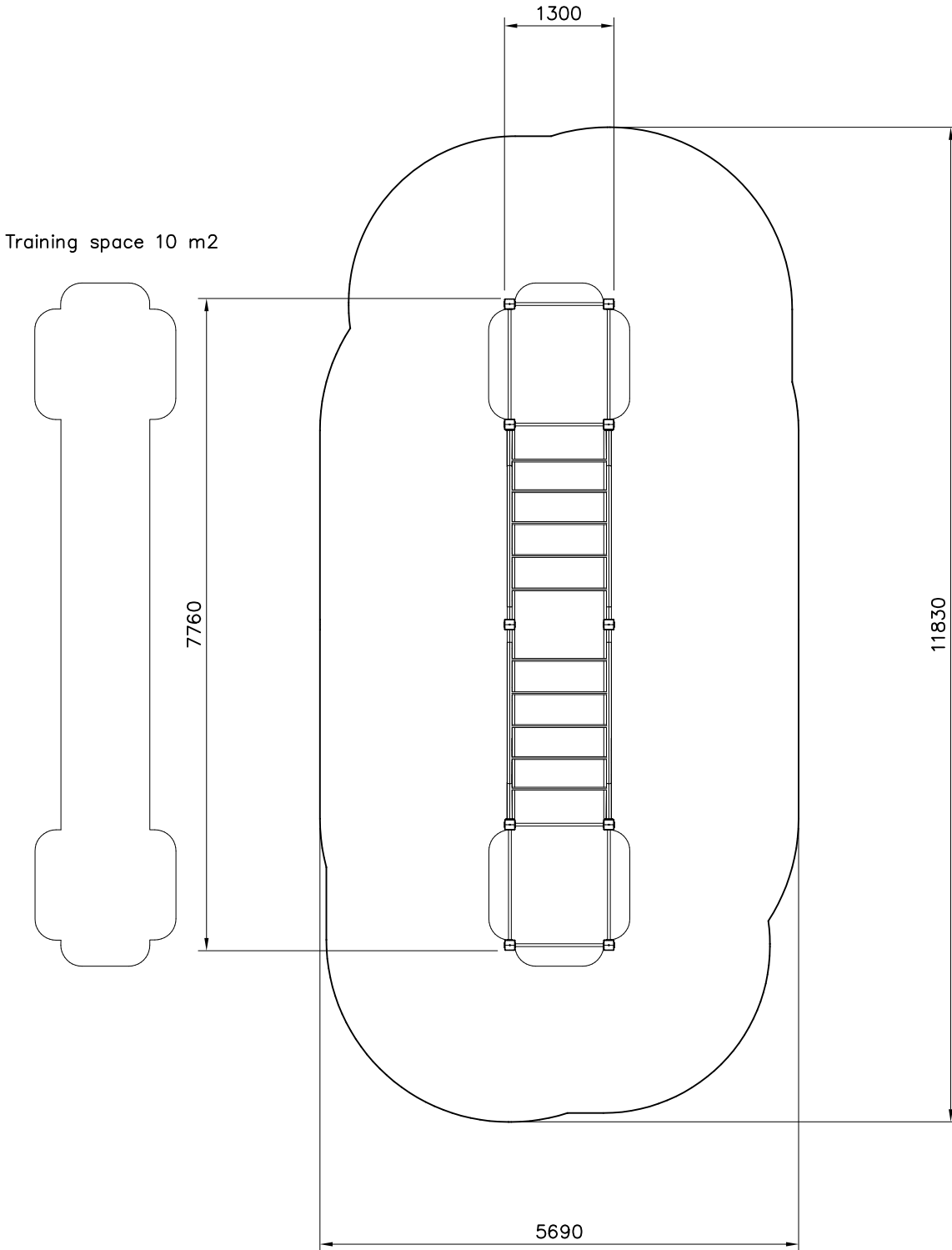

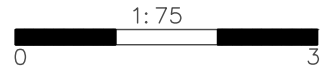

- EN/AS Impact Area 60.7 m<sup>2</sup>
- - - - Falling Space 60.7 m<sup>2</sup>
- Max Falling Height 2610 mm

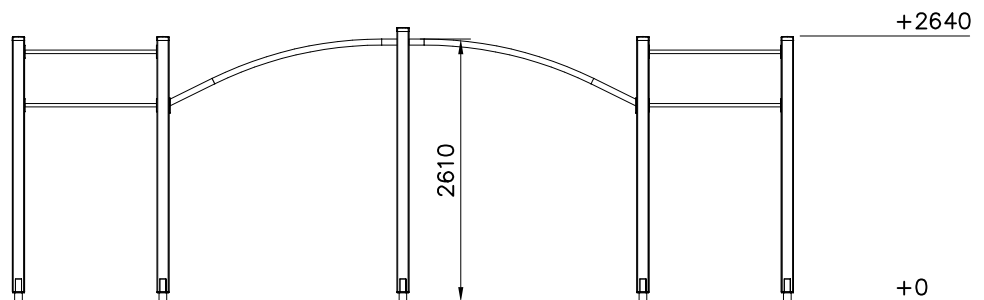

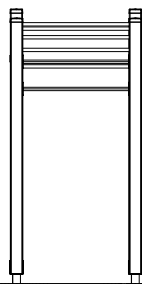
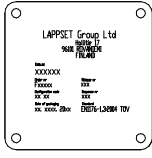

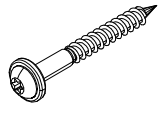
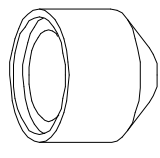
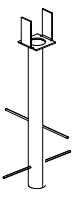
DATE: 13.8.2020

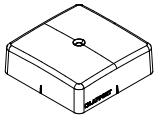
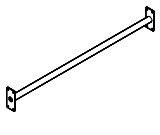
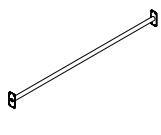
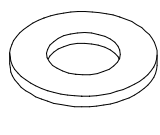
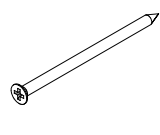
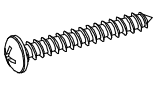
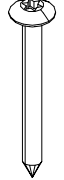
702286  65x65	PCS 1	705234  118x118x2590	PCS 2	705322  118x118x2500	PCS 8	900240  Ø8x70	PCS 32	905104  M10	PCS 40	905761  120x120x700	PCS 10
905800-216  2260x600x1270	PCS 2	905830  123x123x40	PCS 10	905838-216  L 1060	PCS 4	908017-216  L 1315	PCS 4	909256  Ø16/8.4	PCS 104	980104  Ø5x90	PCS 10
980114  Ø4x20	PCS 4	980123  Ø7x60	PCS 104		PCS		PCS		PCS		PCS
	PCS		PCS		PCS		PCS		PCS		PCS
	PCS		PCS		PCS		PCS		PCS		PCS
	PCS		PCS		PCS		PCS		PCS		PCS
	PCS		PCS		PCS		PCS		PCS		PCS