

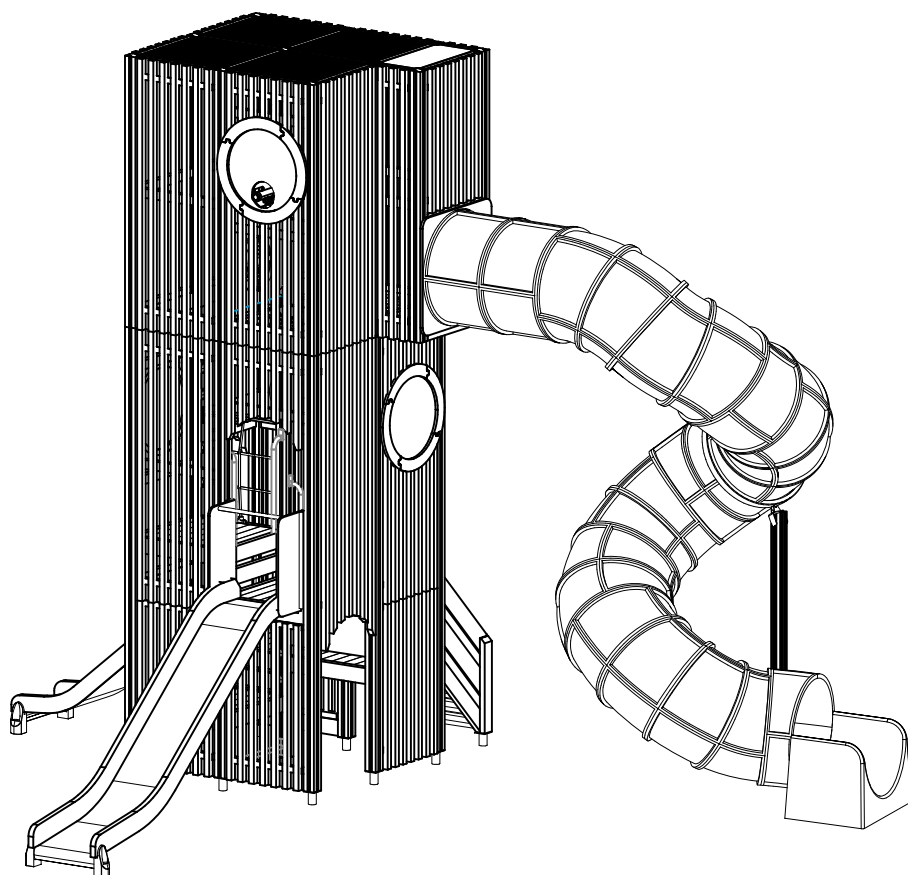













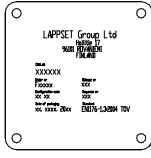
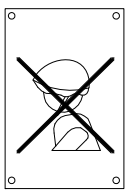
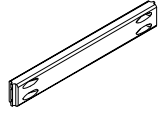
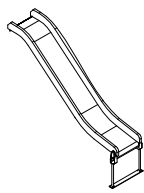

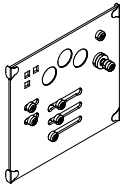
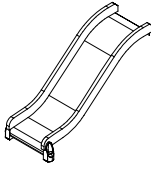

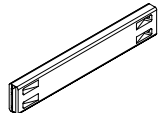
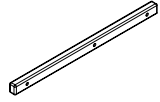
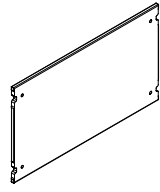

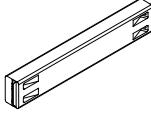
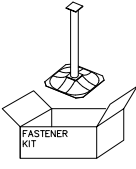
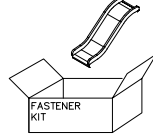
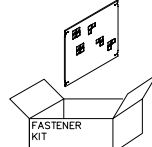
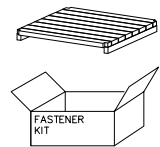
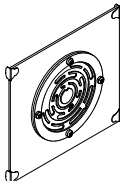
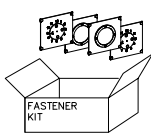
ASENNUSOHJE
MONTERINGSANSVISNING
INSTALLATION INSTRUCTION
AUFBAUANLEITUNG
NOTICE D'INSTALLATION

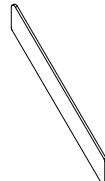
DATE: 23.10.2023

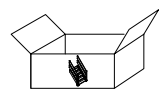

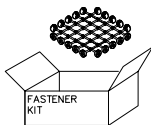
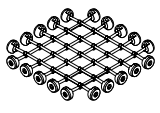
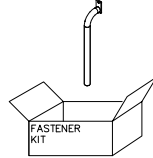
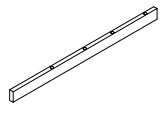
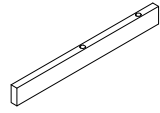
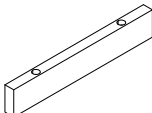

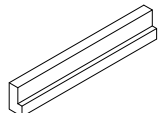
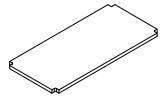
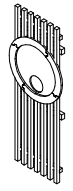
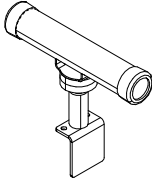
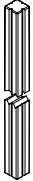
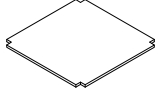
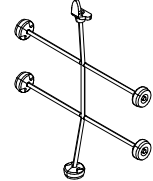
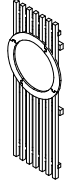





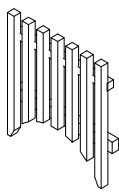
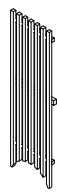

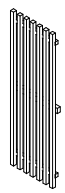
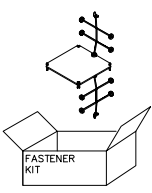
420101

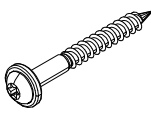
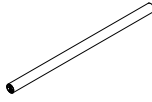
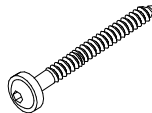

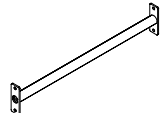
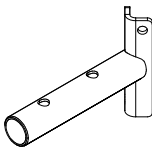
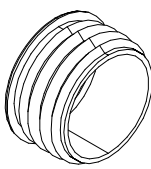
DATE: 23.10.2023

008986  750x750	PCS 5	702286  65x65	PCS 1	702339  118x78	PCS 1	703338-614  45x95x704	PCS 1	705308  Box	PCS 1	705511  Box	PCS 6
705705-701  10x640x702	PCS 1	706234  Box	PCS 1	706371-701  15x345x750	PCS 4	706439-614  L 704	PCS 41	706443  32x45x702	PCS 14	706461-701  15x400x703	PCS 1
706505  35x70x730	PCS 4	706512-614  70x120x704	PCS 1	706531  FASTENER KIT	PCS 12	706533  FASTENER KIT	PCS 2	706534  FASTENER KIT	PCS 1	706535  FASTENER KIT	PCS 5
706766-701  1	PCS 1	706778  FASTENER KIT	PCS 1	707145-614  43x93x717	PCS 2	707146-701  15x145x1153	PCS 4	707191-614  +870	PCS 1	707224  1	PCS 1
707449  FASTENER KIT	PCS 1	707588  FASTENER KIT	PCS 2	707590-303  755x755	PCS 2	707732  FASTENER KIT	PCS 6	711295-614  L 1900 Holes	PCS 2	711297-614  L 1900 Holes	PCS 2
711298-614  L 704 Holes	PCS 17	711299-614  93x93x2050	PCS 8	711300-614  93x93x2050	PCS 3	711310-614  68x120x704	PCS 1	711312  715x460x20	PCS 2	711314-614  H 2050	PCS 1
711317  1	PCS 1	711320-614  93x93x3300	PCS 9	711323-701  20x750x750	PCS 1	711324-303  705x788	PCS 2	711329-614  H 2050	PCS 3	711339-614  H 1090	PCS 1

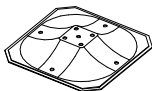
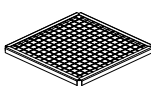
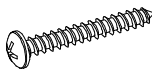
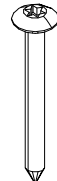
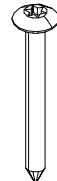
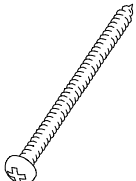
DATE: 23.10.2023

711340-614	PCS	711342-614	PCS	711343-614	PCS	711344-614	PCS	711345-614	PCS	711414	PCS
	5		2		1		2		7		1
H 1250		H 725		H 2250		H 2050		H 2050		FASTENER KIT	
711424-614	PCS	900240	PCS	901868	PCS	903093	PCS	907688-216	PCS	907694-216	PCS
	1		4		2		427		6		1
H 1250		Ø8x70		Ø34x598		Ø8x90				L 704	
907783-216	PCS	908969	PCS	909144	PCS	909248	PCS	909253	PCS	909511	PCS
	4		92		46		46		92		12
120x40x180		Ø35/33-31 L20		M12x220		M12		Ø32/13.5/2		90x90x650	
909519	PCS	910745-216	PCS	980114	PCS	980123	PCS	980128	PCS	980131	PCS
	12		4		8		12		76		8
50x380x380		751x751x40		Ø4x20		Ø7x60		Ø7x40		Ø6x60	
A10970	PCS	P14604	PCS		PCS		PCS		PCS		PCS
	1		1								
+3520 G		l=1950									
	PCS		PCS		PCS		PCS		PCS		PCS
	PCS		PCS		PCS		PCS		PCS		PCS

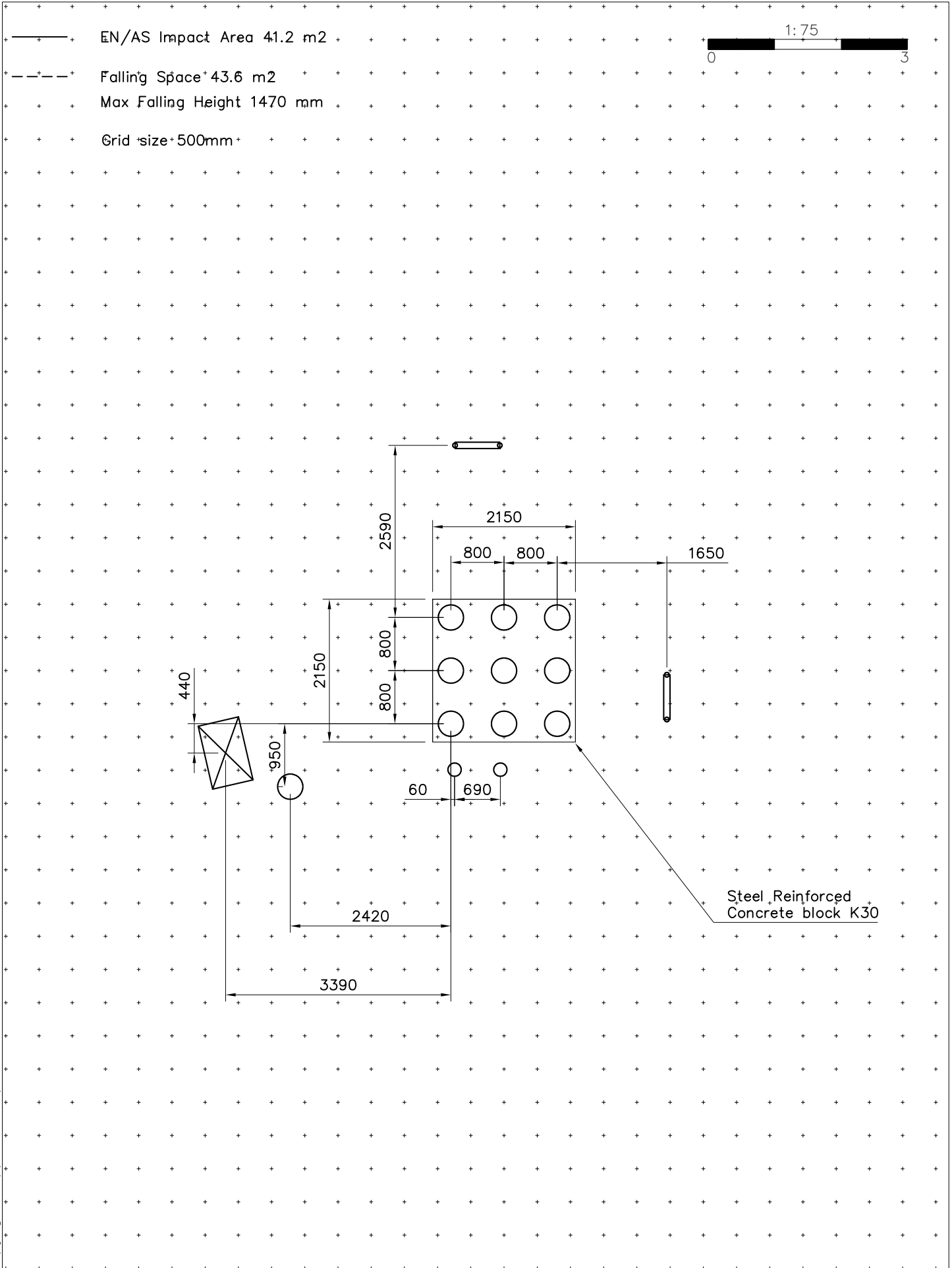

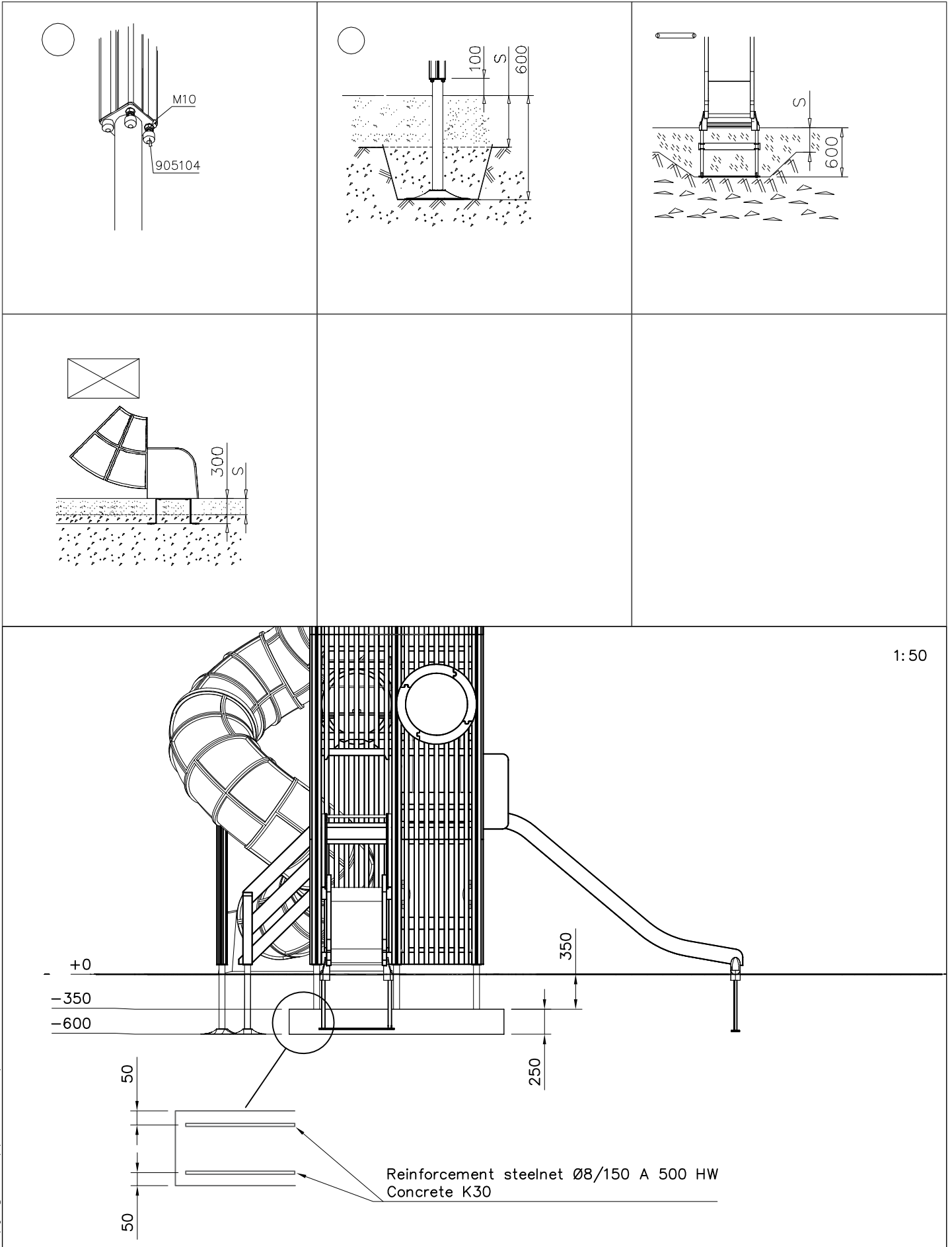

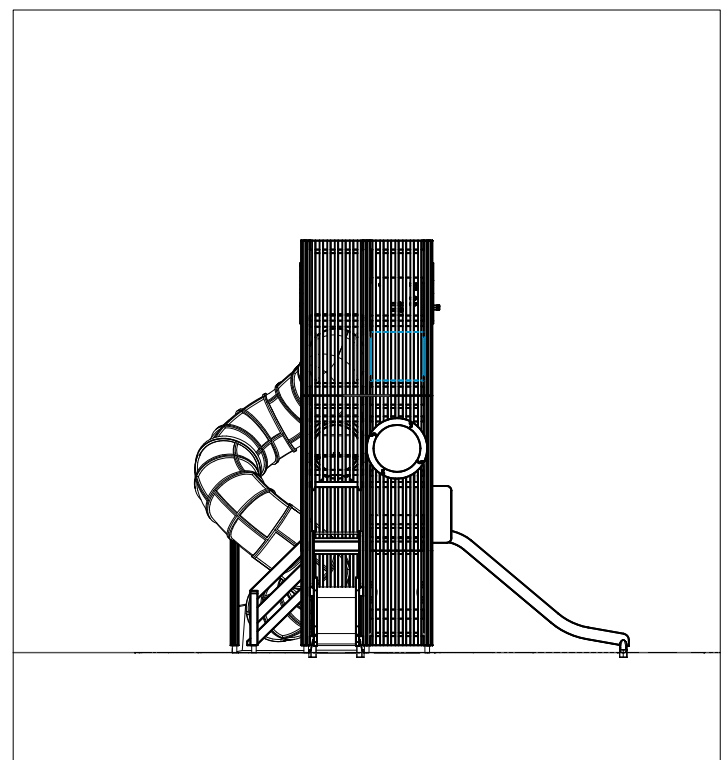
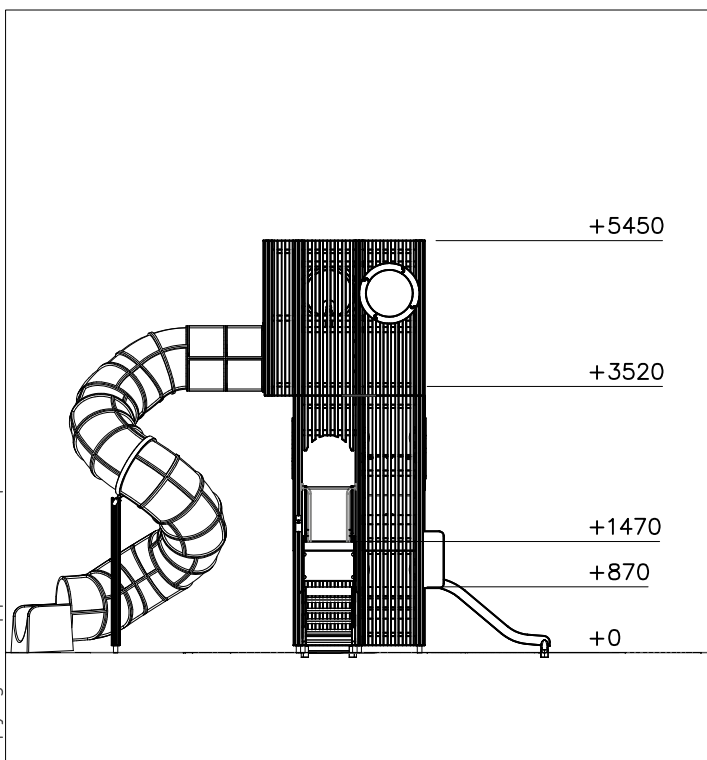
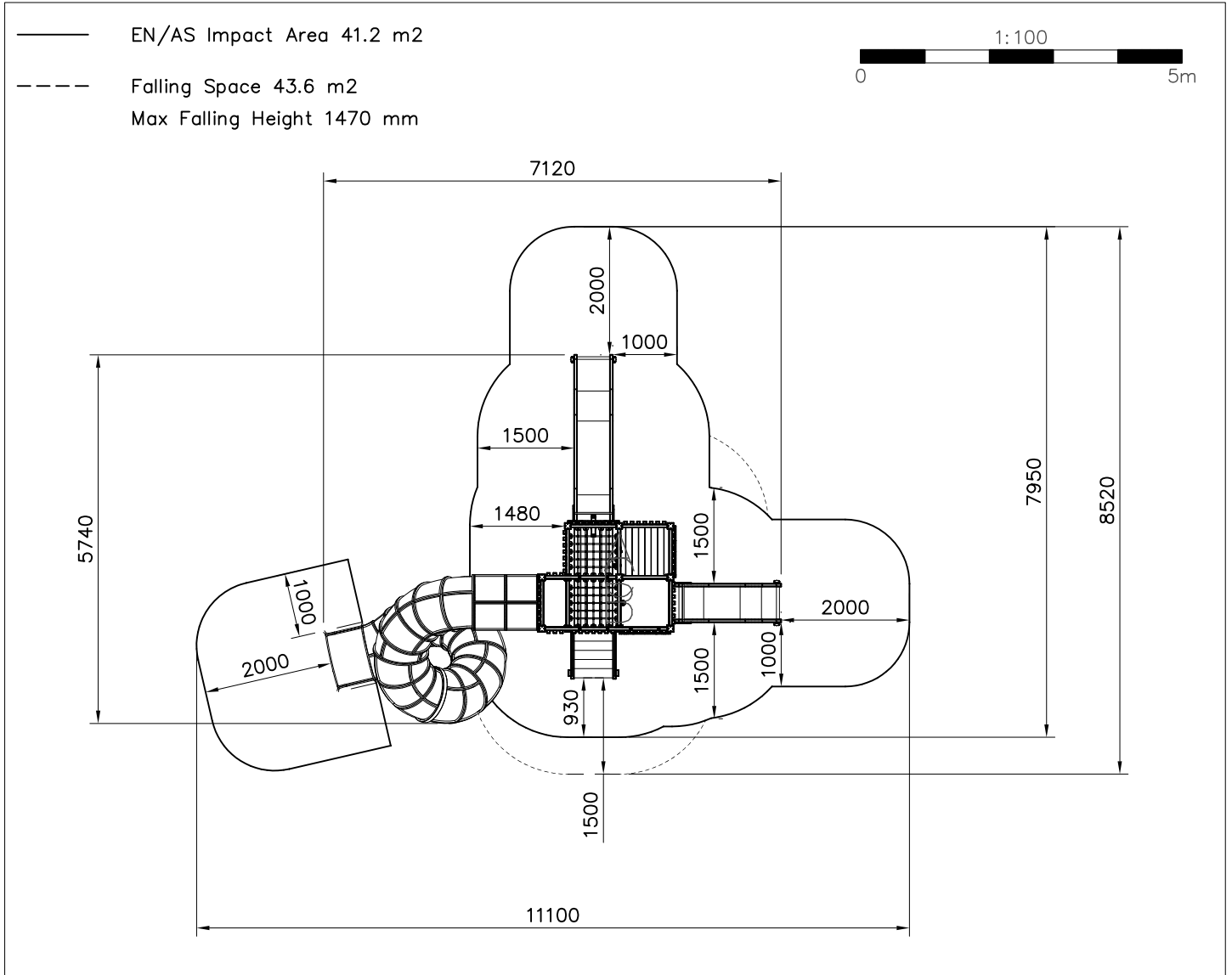

OPTION A

Building structure from down to up. This solution needs 1–2 person lift to install the frame and accessory to the tower. Note the direction of the balcony.

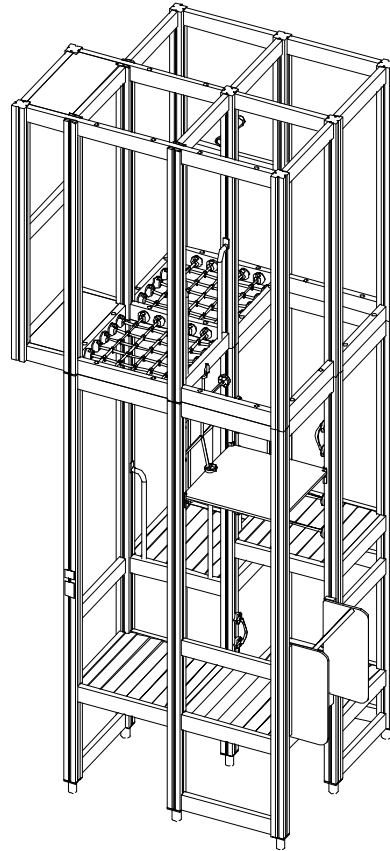

OPTION B

Building structure in the ground and using a crane to lift the upper part of the tower in place. Note the direction of the balcony.

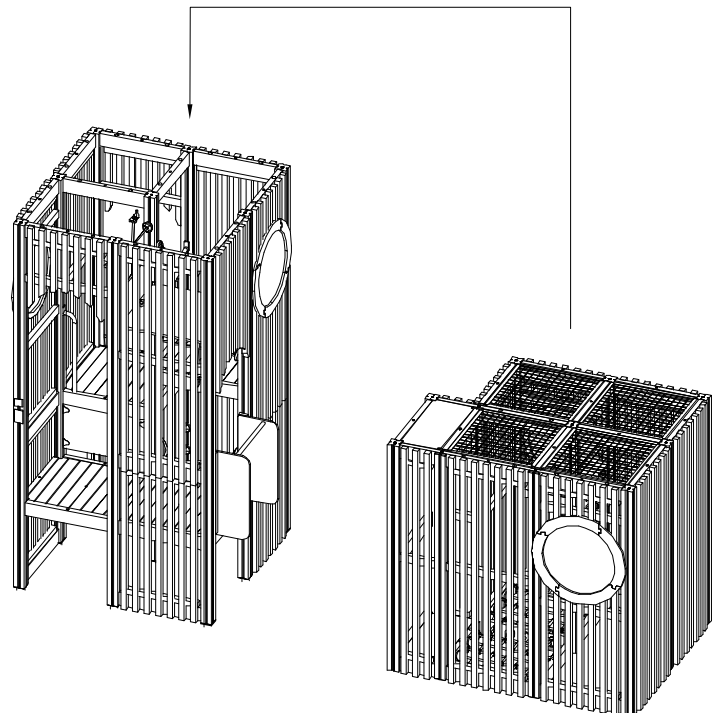

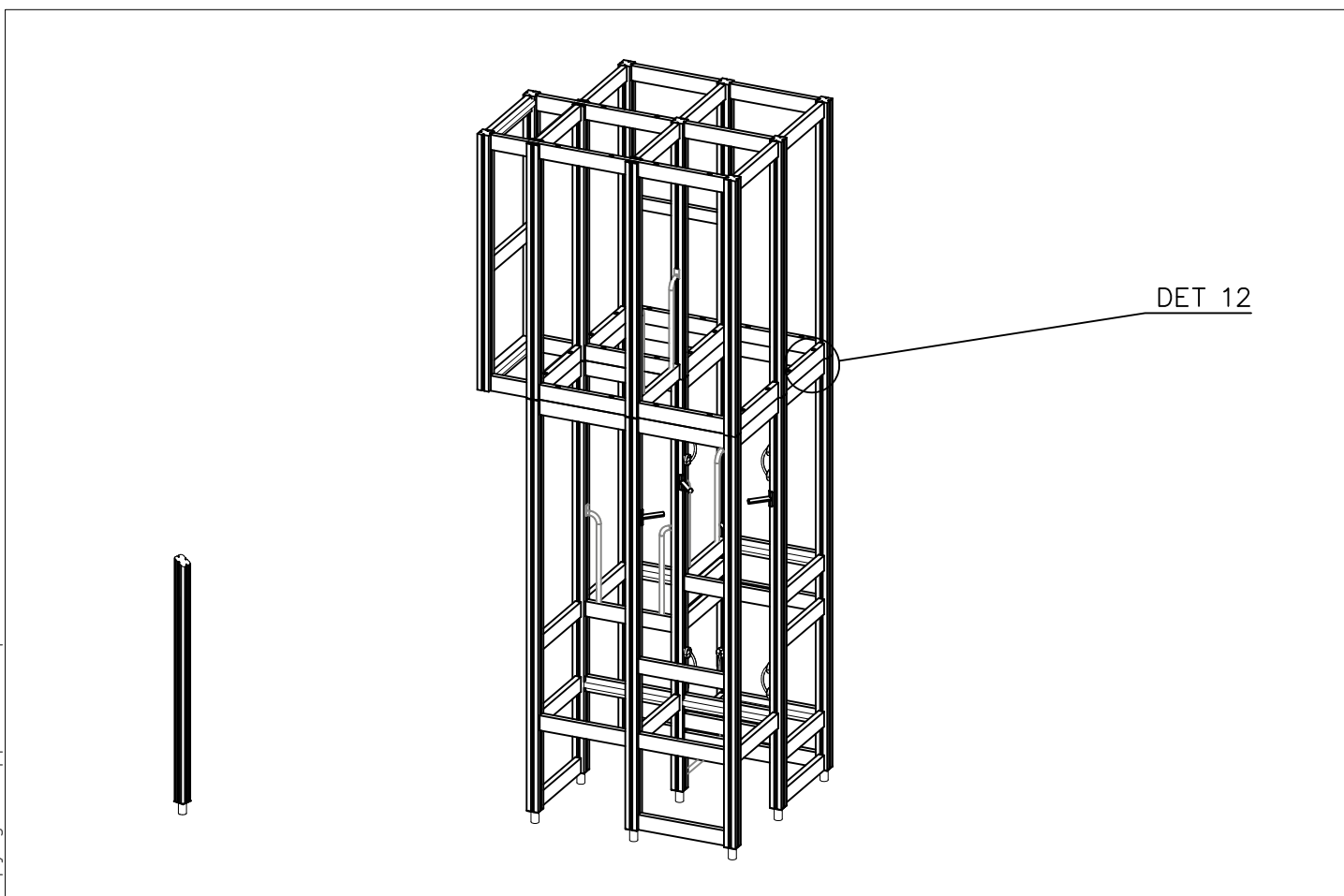
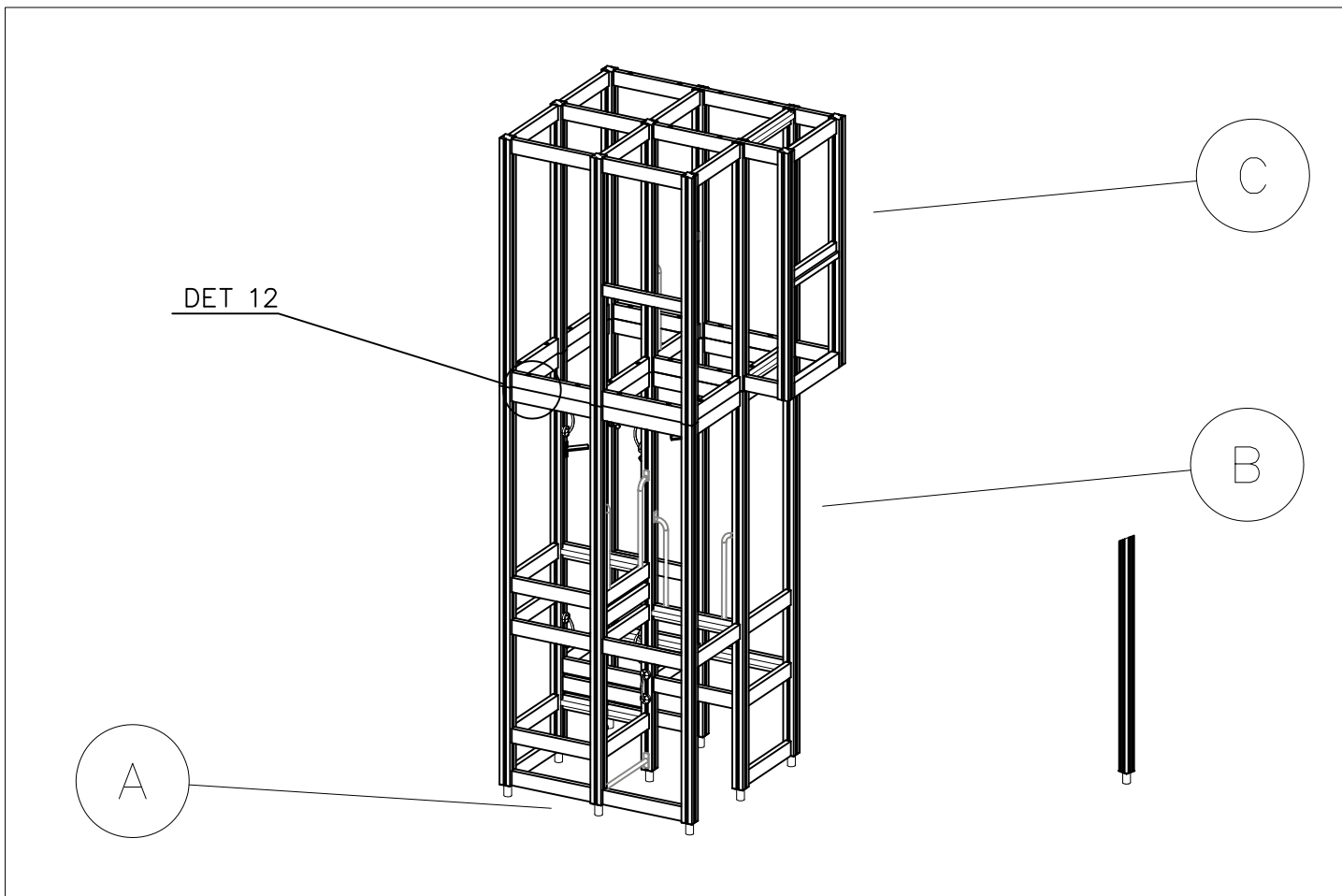

<p>DET 1</p> <p>Ø8x90 (903093)</p>	<p>DET 2</p> <p>Ø8x90 (903093)</p>	<p>DET 3</p> <p>PRE-DRILL HOLE. Ø5 ↓ 40</p> <p>907694</p> <p>Ø8x70 (900240)</p>	<p>DET 4</p> <p>Pre-drill hole. Ø6 ↓ 60</p> <p>100</p>
<p>DET 5</p> <p>M10x80 (900727)</p>	<p>DET 6</p> <p>25</p>	<p>DET 7</p> <p>PRE-DRILL HOLE. Ø5 ↓ 40</p> <p>Ø8x70 (900240)</p>	<p>DET 8</p> <p>7x40</p>
<p>DET 9</p> <p>711317</p> <p>4x Ø7x40</p>	<p>DET 10</p> <p>Ø8x70 (900240)</p> <p>22</p> <p>706443</p>	<p>DET 11</p> <p>2x Ø8x90</p> <p>Pre-drill Ø5 !!!</p>	<p>DET 12</p> <p>Ø35/33</p> <p>M12x220</p> <p>Ø32/13.5</p> <p>M12</p>
<p>DET 13</p> <p>711300</p> <p>4x Ø7x40</p> <p>Pre-drill Ø5 !!!</p>	<p>DET 14</p> <p>4x Ø6x60</p>	<p>HOX !! DET 11</p> <p>Pre-drilling boom fixing holes is MANDATORY when boom is near the end of the post!!</p> <p>Otherwise post end will crack and we cannot ensure structural strength and durability.</p>	
<p>DET 15</p> <p>3x Ø8x90</p>	<p>DET 16</p> <p>2x Ø8x90</p>		

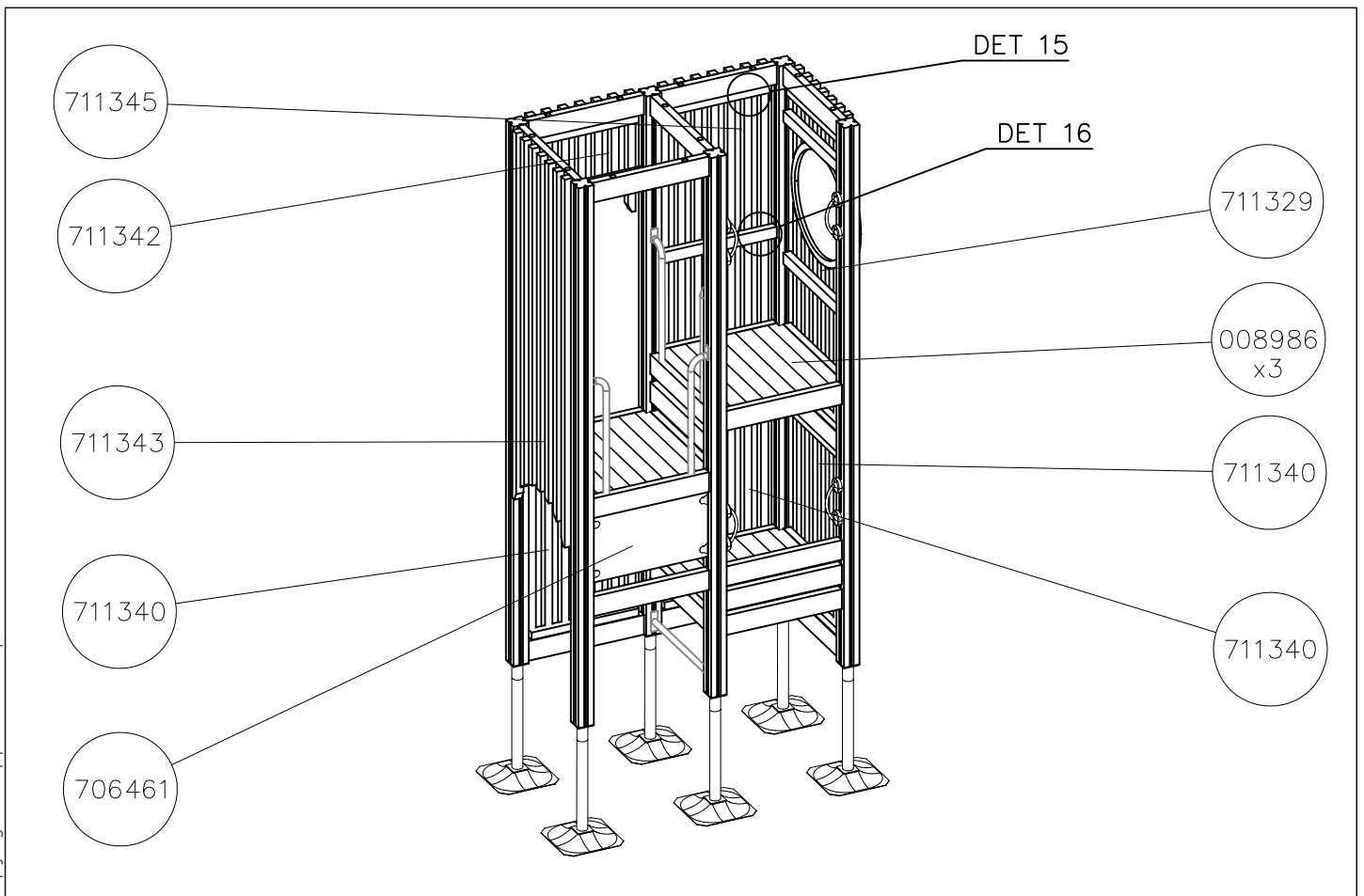
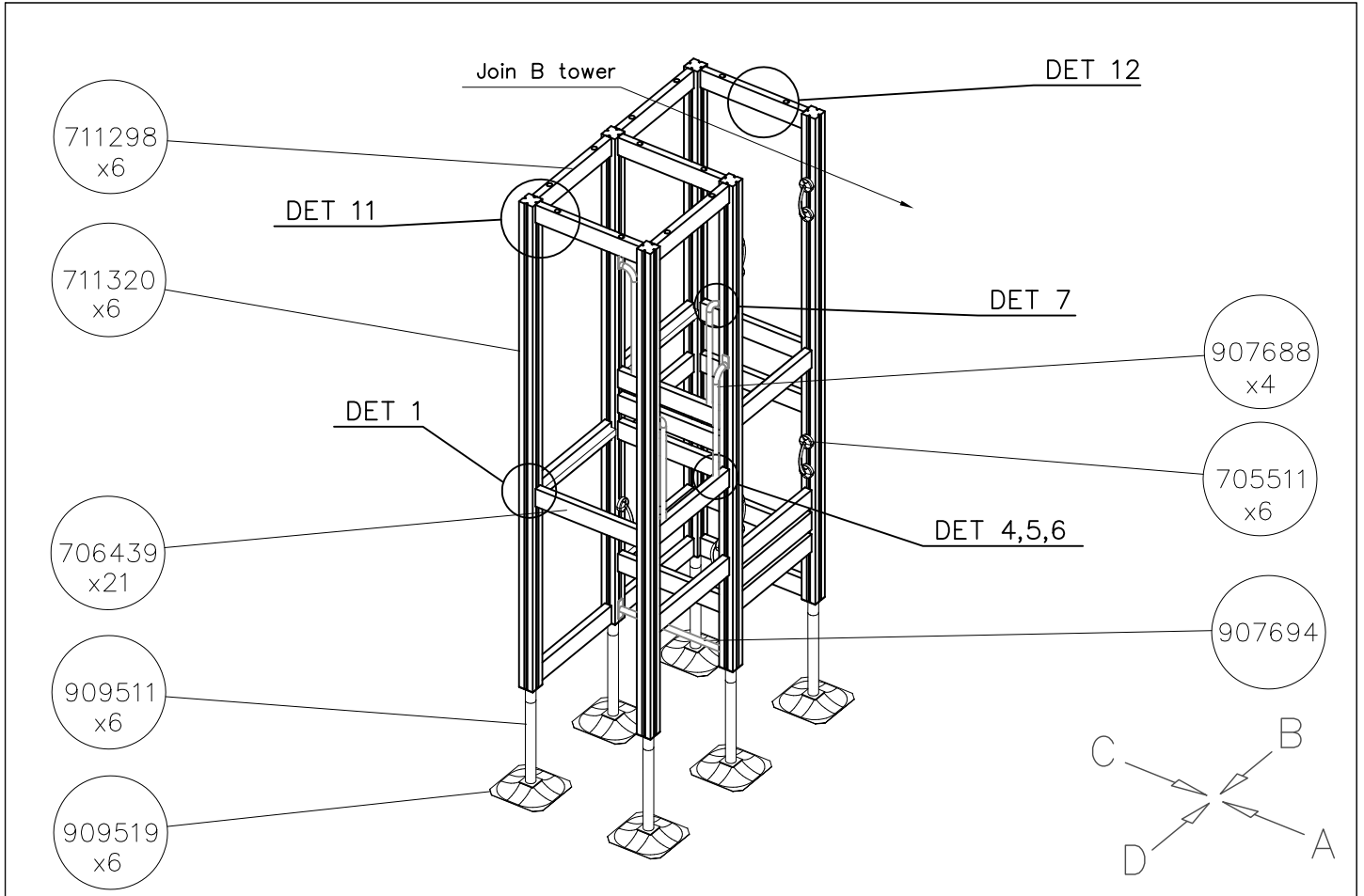

1:50

A

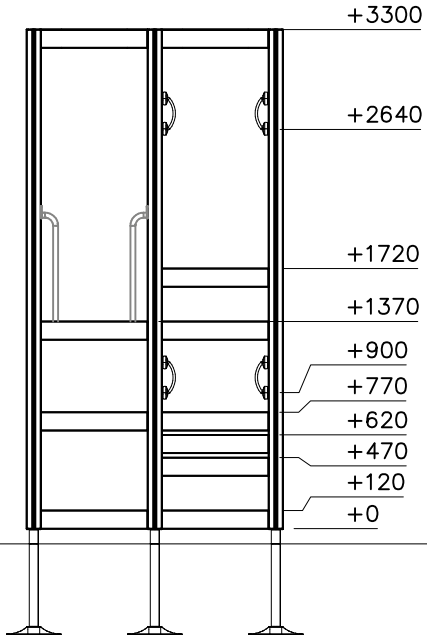

B

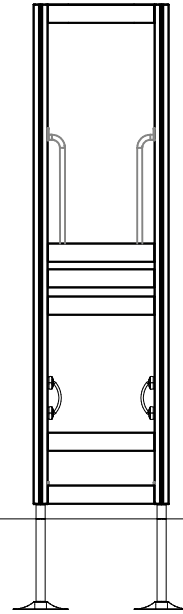

C

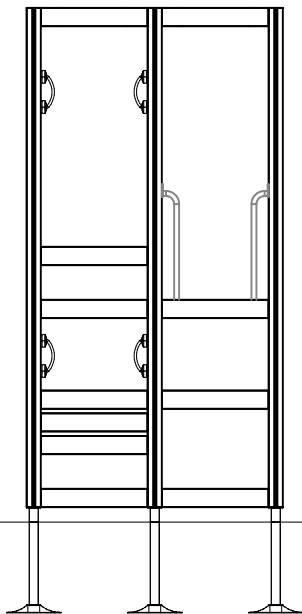

D

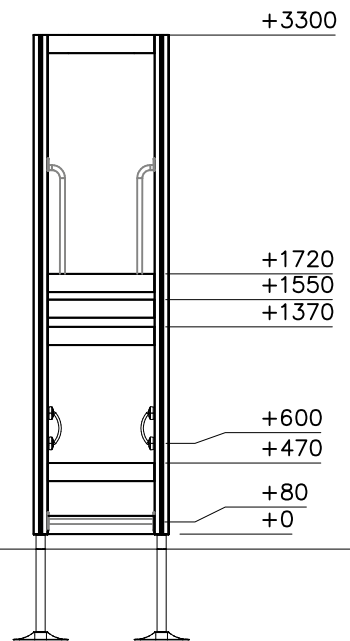

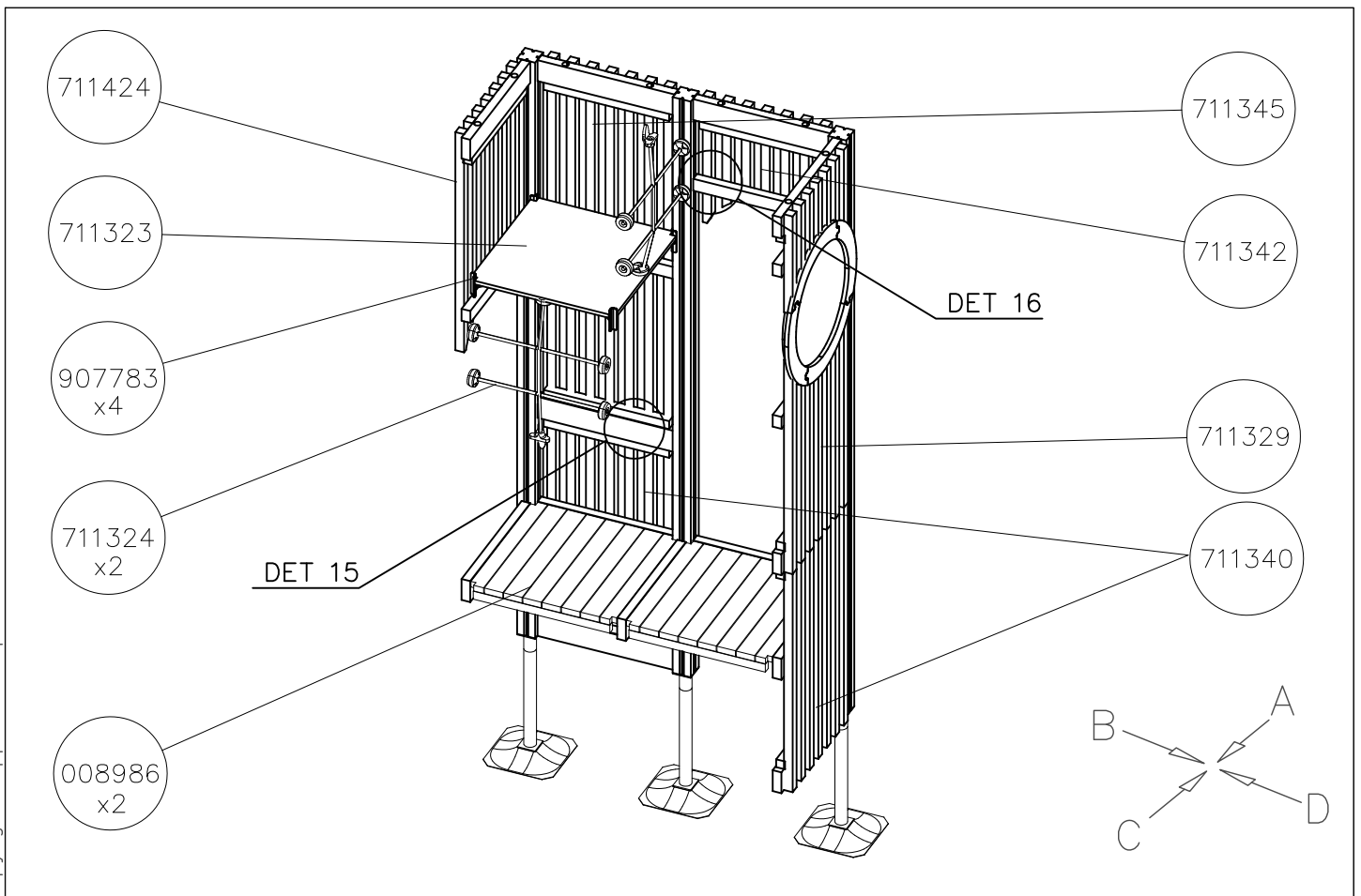
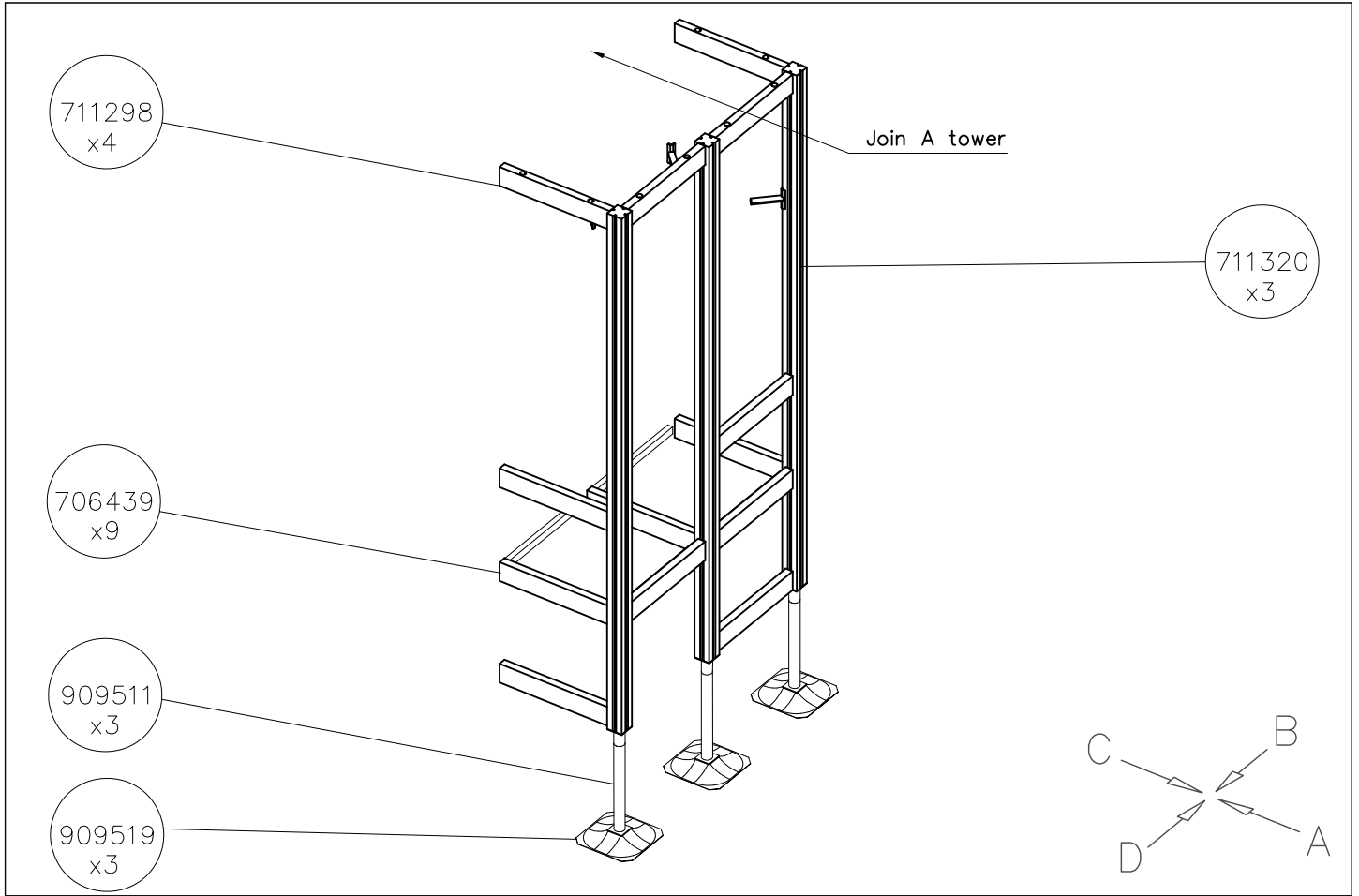

1:50

A

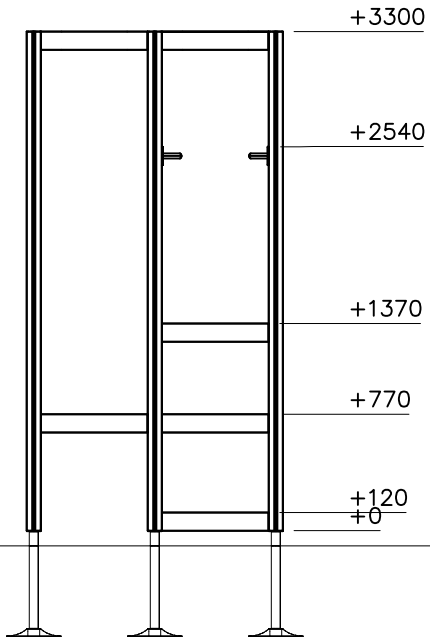

B

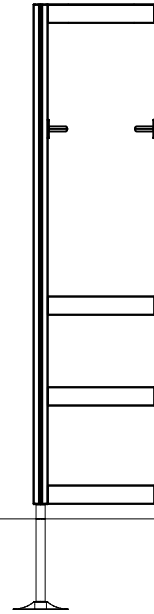

C

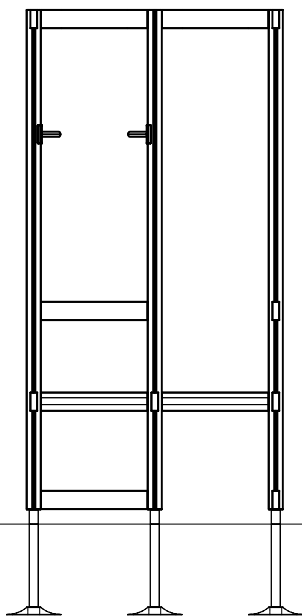

D

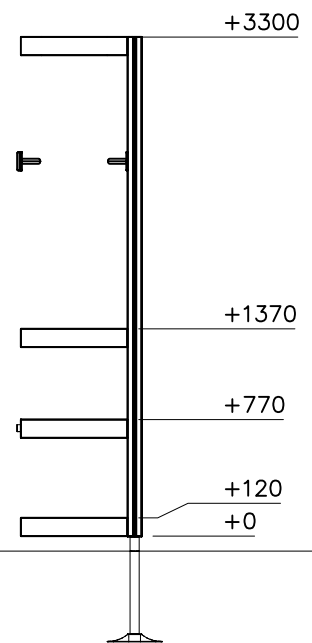

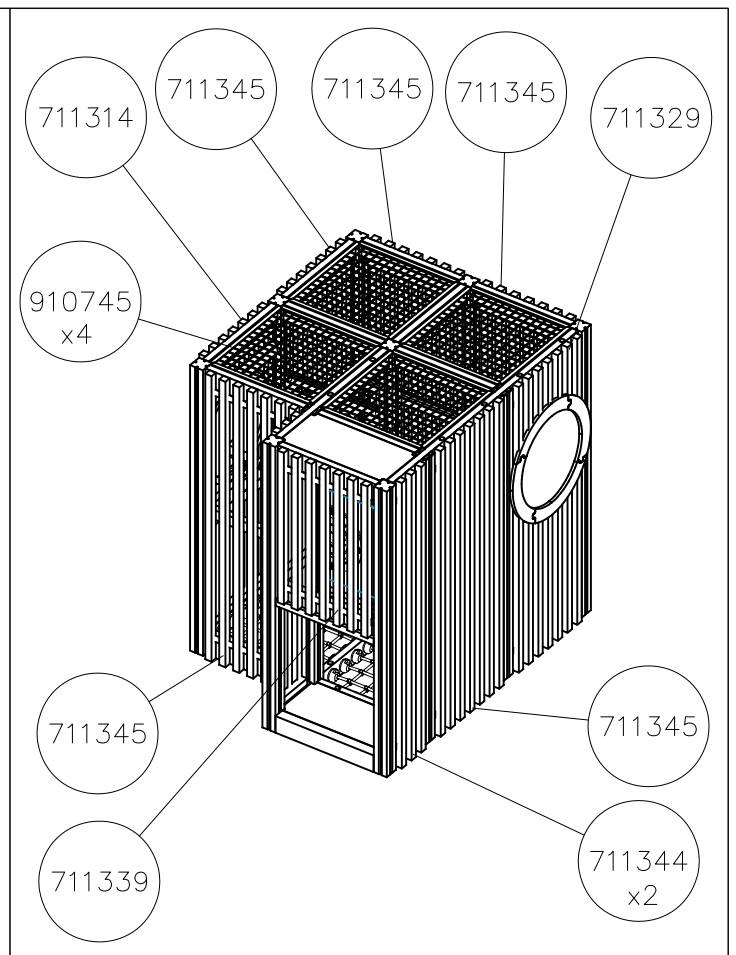
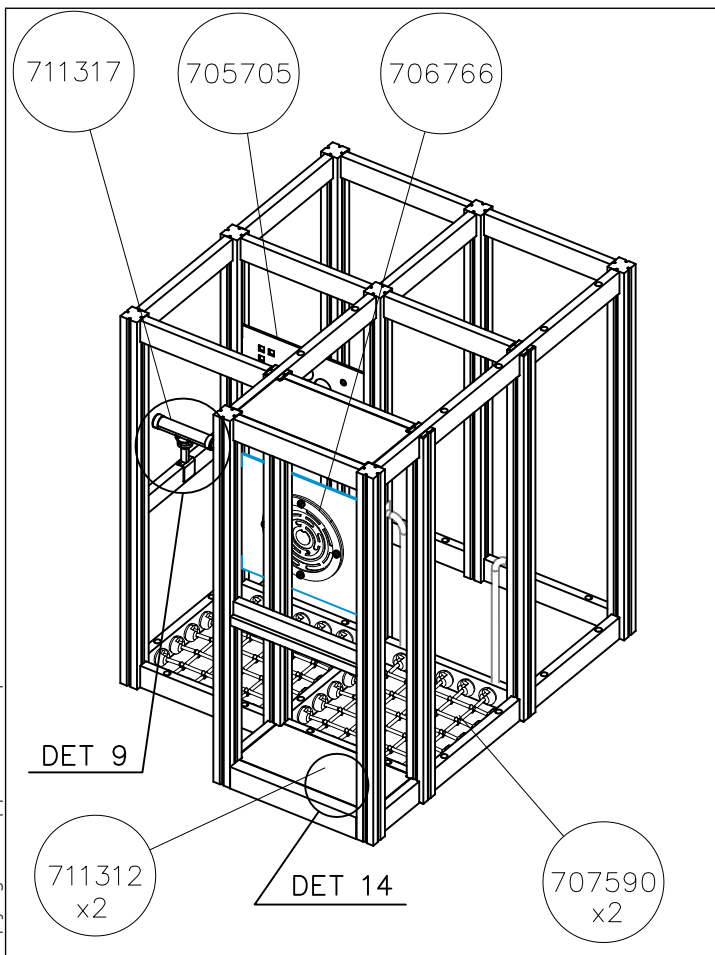
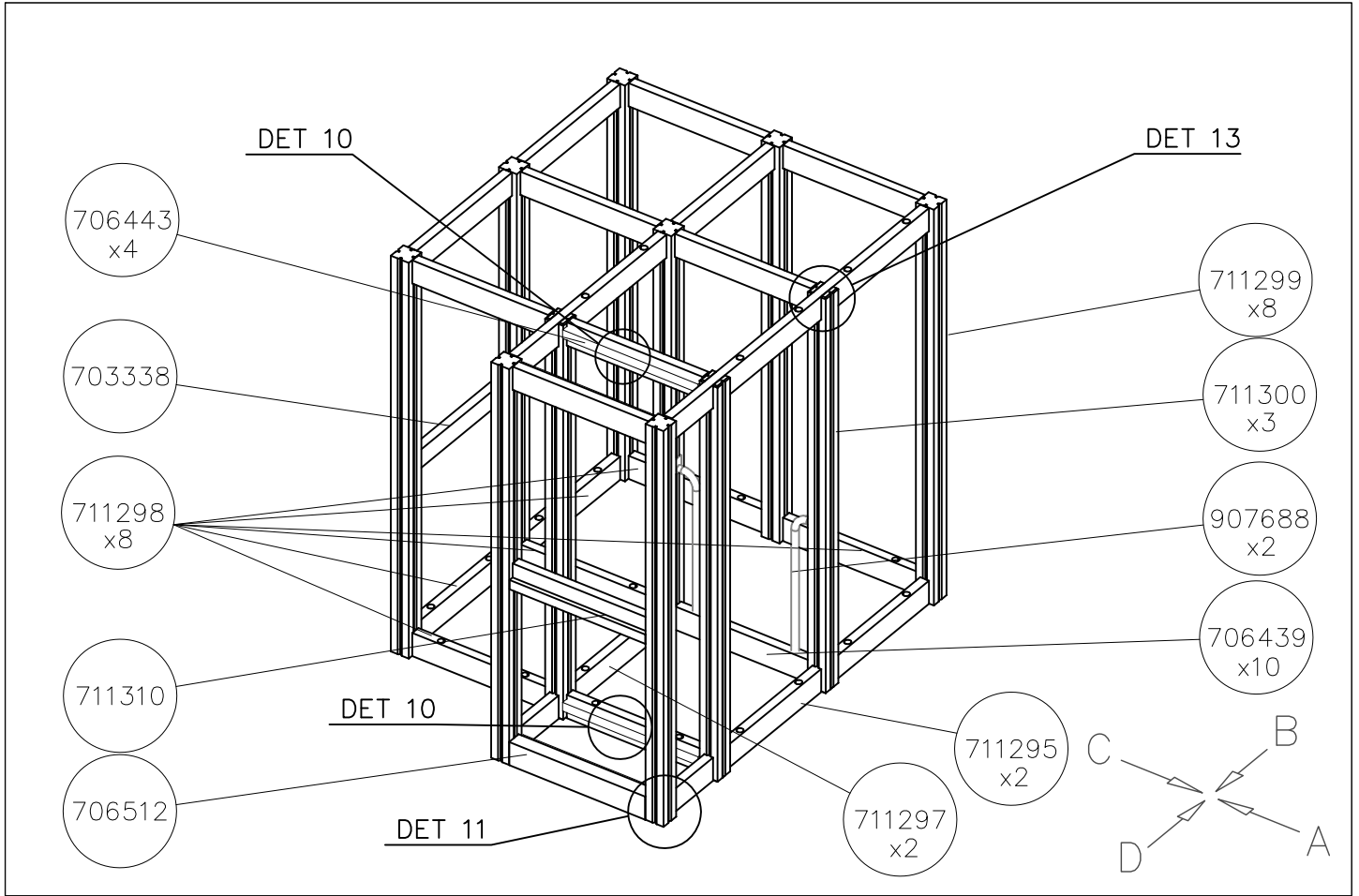

DATE: 23.10.2023

1:50

A

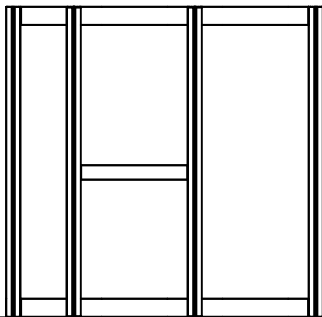

B

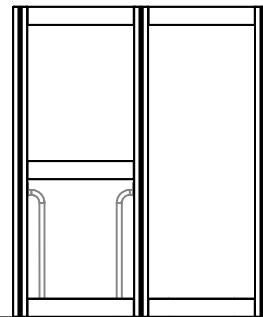

C

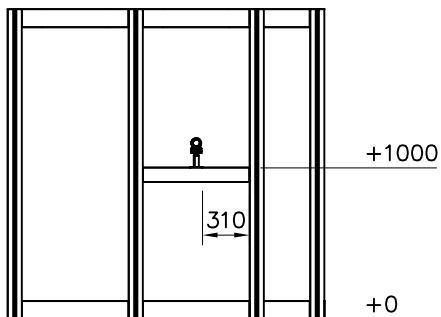

D

