

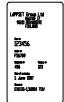

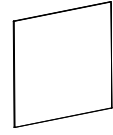

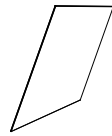

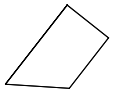



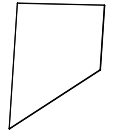







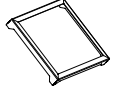



| | | | |
|---|-----------|--|-----------|
| ① 702341  90x50 | PCS 1 | ② 709159  15x1200x1486 | PCS 1 |
| ③ 709160  15x1486x2174 | PCS 1 | ④ 709161  15x1170x2170 | PCS 1 |
| ⑤ 709162  15x1376x1486 | PCS 1 | ⑥ 709163  15x1170x1620 | PCS 1 |
| ⑦ 709164  18x80x1135 | PCS 2 | ⑧ 709165  18x80x1420 | PCS 2 |
| ⑨ 902233  M10x30 | PCS 24 | ⑩ 905112  Ø22 | PCS 24 |
| ⑪ 909637  M10 | PCS 24 | ⑫ 909638  Ø20/10.5 | PCS 48 |
| ⑬ 909876  M8x40 | PCS 48 | ⑭ 910744  154x1160x1445 | PCS 1 |

| | | | | | | | | | | | |
|---|----------|---|----------|---|----------|--|----------|---|----------|--|----------|
| ⑮ 910768  30x60x1349 | PCS 2 | ⑯ 910769  30x60x1504 | PCS 2 | ⑰ 910793  L 2158 | PCS 1 | ⑱ 910794  L 1425 | PCS 1 | ⑲ 910795  L 1646 | PCS 1 | ⑳ 910796  L 884 | PCS 1 |
|---|----------|---|----------|---|----------|--|----------|---|----------|--|----------|

| | | | | | | | | | | | | | |
|----|---|-----|----|---|-----|----|---|-----|----|---|-----|---|-----|
| ②1 | 980108 | PCS | ②2 | 980128 | PCS | ②3 | 980150 | PCS | ②4 | 980151 | PCS | FOOT OPTION | |
| |  | 4 | |  | 12 | |  | 48 | |  | 48 | 709387+ | |
| | Ø4x25 | | | Ø7x40 | | | M8 | | | Ø16/8.4 | | ○ 709386 | PCS |
| | | | | | | | | | | | | SURFACE | 1 |
| | | | | | | | | | | | | ○ 910567 | PCS |
| | | | | | | | | | | | | CONCRETE | 4 |
| | | | | | | | | | | | |  | |
| | | | | | | | | | | | | M16x170 | |
| | | | | | | | | | | | |  | |
| | | | | | | | | | | | | 117x117x715 | |



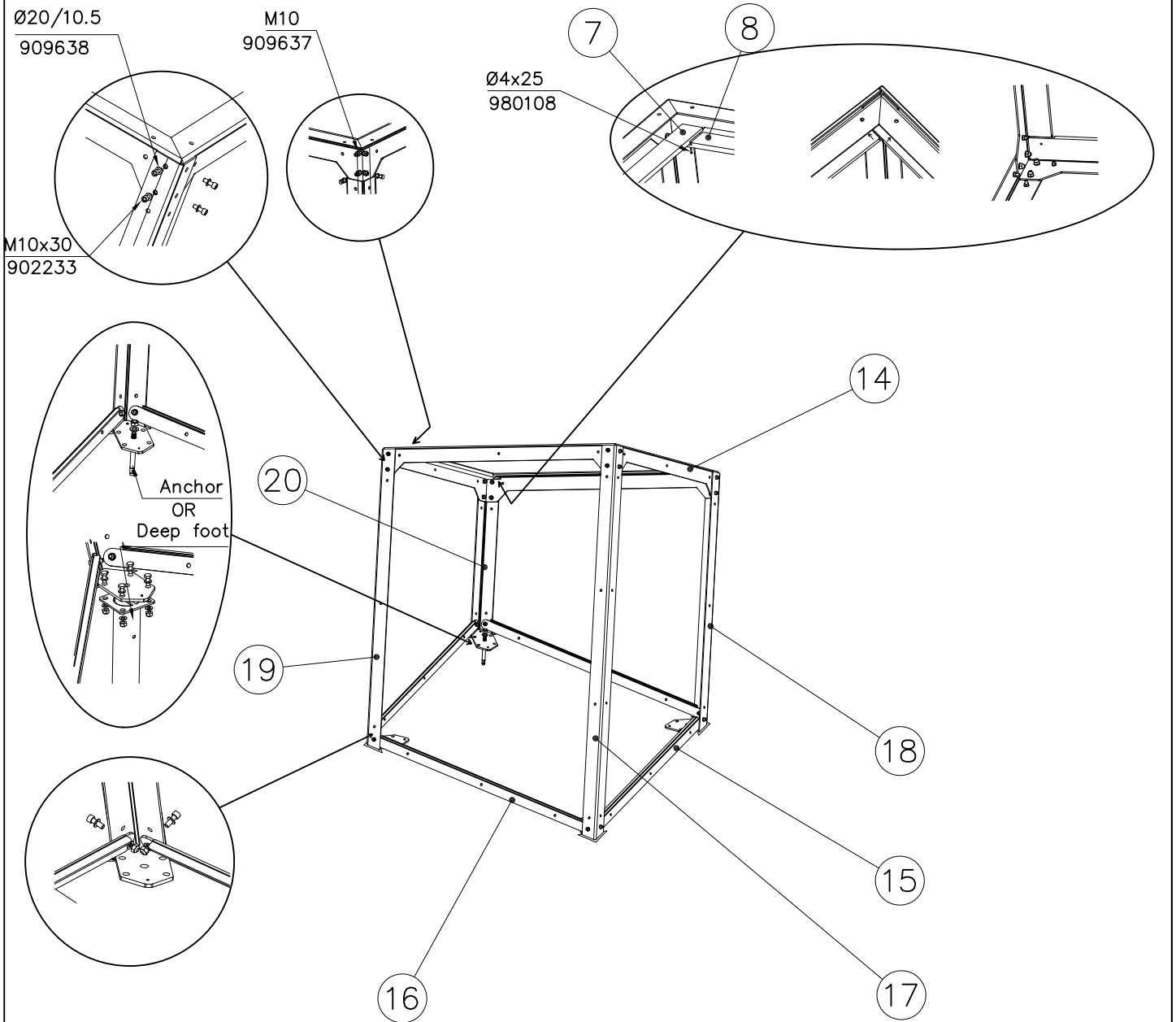
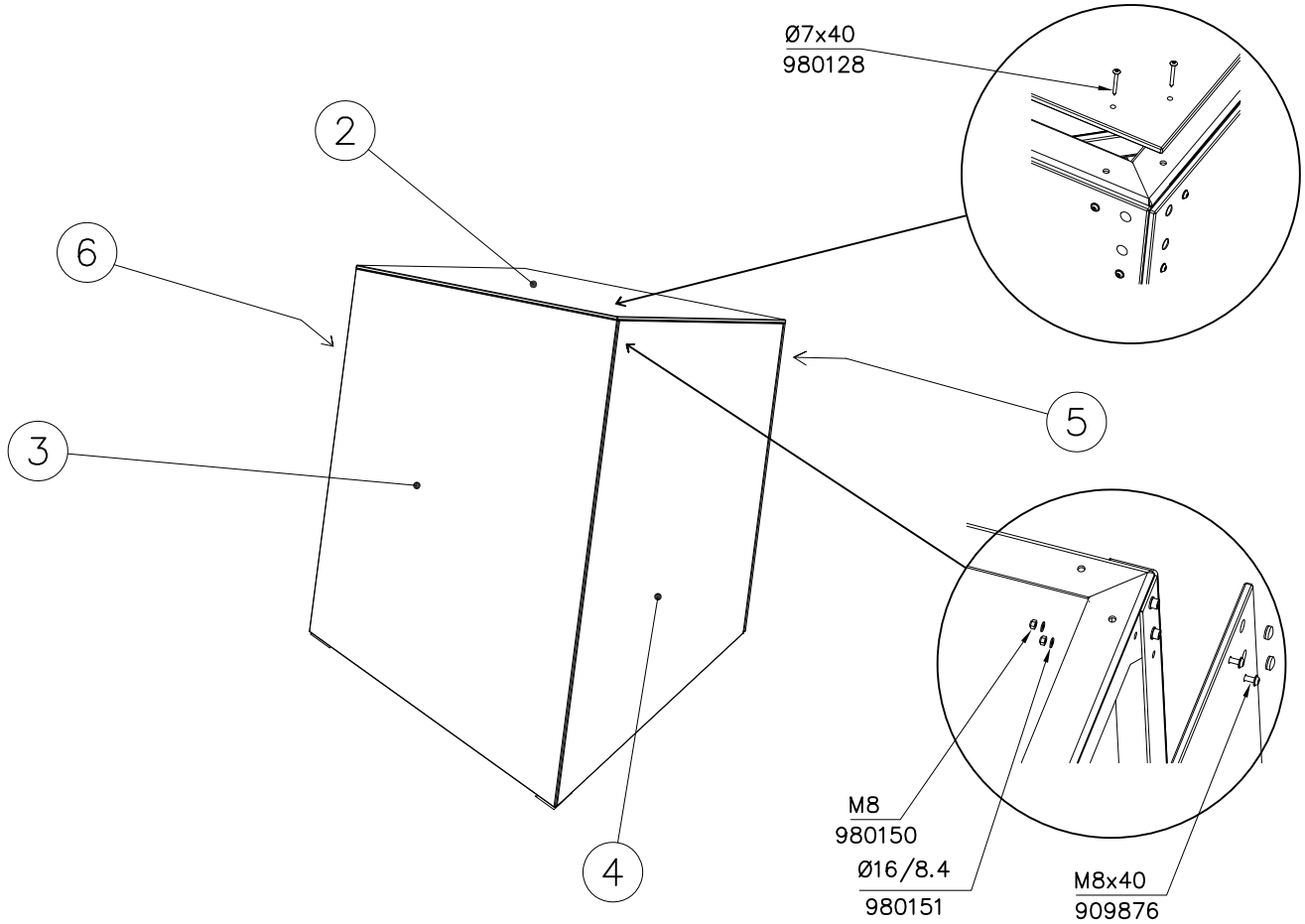

—— EN Impact Attenuating Surface (IAS) 24.4 m²

---- Falling Space 24.4 m²

Max Falling Height 1740 mm

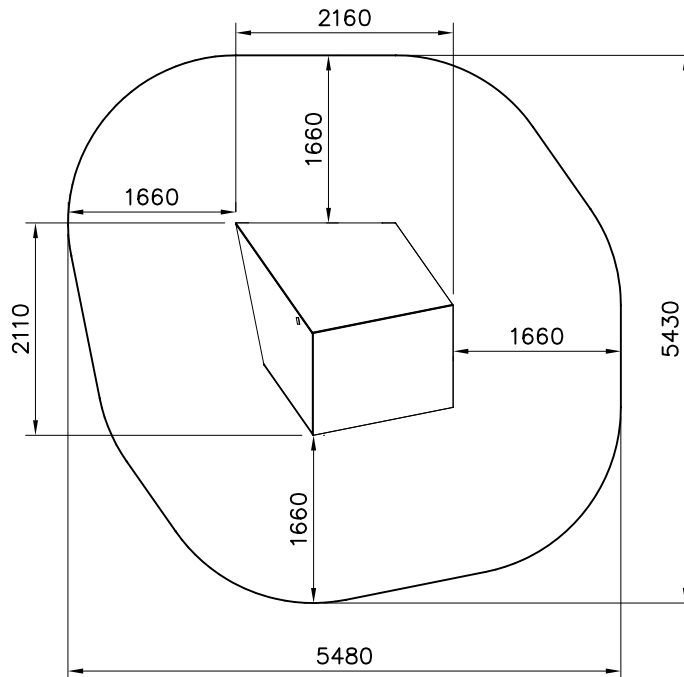
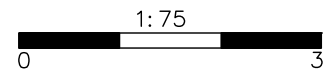

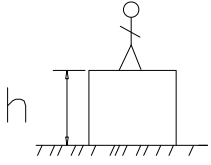

$h < 1600$

Totally hard surfaces or materials with very limited impact attenuating properties.

Case by case risk assessment is needed including e.g. evaluation whether there is forced movement, what is the intended exercise and where will the product be installed.

Materials with significant impact attenuating properties.

Totally hard surfaces.
E.g. concrete or asphalt



Materials with very limited impact attenuating properties.
E.g. wood



fine gravel 0–8 mm



Unsorted sand/ topsoil

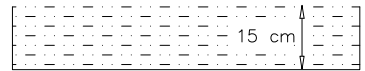

Lawn

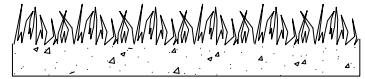

$h = 1600-$

$h < 3000$

Loose fill material

E.g.
sand/gravel 0,25...8 mm $D_{60}/D_{10} < 3,0$
Woodchips 5...30 mm
bark 20...80 mm

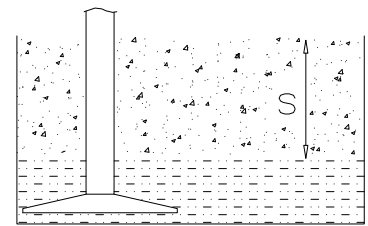

\underline{S}
30 cm \underline{h}
 < 3,0 m

Synthetic granulates

| \underline{S} | \underline{h} |
|-----------------|--------------------|
| 40 mm | ~> 1,6...~< 1,8 m |
| 50 mm | ~> 1,8...~< 2,25 m |
| 55 mm | ~> 2,25...~< 2,4 m |
| 60 mm | ~> 2,4...~< 2,55 m |
| 70 mm | ~> 2,55...~< 3,0 m |

Note. For accurate values, see manufacturer's instructions.

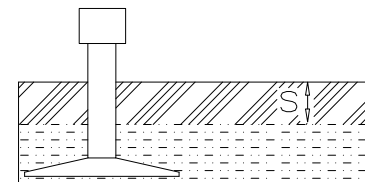



Tuotekyltti tulee tuotteen mukana yhdellä seuraavista tavoista:

1) Metallinen tuotekyltti ja kiinnitysruuvit

- Kiinnitä tuotekyltti ruuveilla tolppaan noin 2 metrin korkeuteen kuvan 1 mukaisesti.

2) Tuotekylttitarra

- Puhdista maalattu metalli- tai vaneripinta pölystä ja kosteudesta. Liimaa tarra kuvan 2 mukaisesti.
- Huom. Älä kiinnitä tarraa karheapintaiseen laminaattiin tai maalattuun puuhun.

Vår produktmärkning levereras på ett av följande sätt:

1) Produktskylt i metall

- Fäst skylten med de medföljande skruvarna

2) Självhäftande produktetikett

- Rengör den pulverlackerade metallytan eller laminatyten så att den blir fri från smuts och fukt. Fäst etiketten enligt fig. 2.
- Obs! Fäst ej etiketten på detaljer med skrovlig yta eller på målat trä.

Product label is delivered by one of following ways:

1) Metal product label and screws

- Fasten the label with screws.

2) Label sticker

- Clean the painted metal or plywood surface from dirt and moisture. Fasten the sticker as shown in the figure 2.
- Note. Do not attach the sticker to rough surfaced laminate or painted wood.

La plaque d'informations produit est livrée sous l'une de ces 3 formes :

1) Plaque métallique et vis

- Fixez la plaque à l'aide des vis.

2) Etiquette autocollante

- Avant de coller l'étiquette, nettoyez le composant métallique peint ou la plaque de contreplaqué, de toute saleté. La surface doit être sèche (voir image 2).
- Attention, ne pas coller l'étiquette sur une surface lamellé-collée irrégulière ou sur du bois peint.

Die Auslieferung des Produktaufklebers erfolgt auf eine dieser Arten:

1) Produkt-Schild aus Metall incl. Schrauben

- Die Befestigung des Schildes erfolgt mittels der Schrauben.

2) Aufkleber

- Entfernen Sie zunächst Schmutz und Feuchtigkeit vom lackierten Metall bzw. von der Holzoberfläche und bringen Sie den Aufkleber wie im Bild oben rechts beschrieben auf den gesäuberten Untergrund auf.
- Beachten Sie: Bringen Sie den Aufkleber nicht auf raues laminiertes oder lackiertes Holz an.

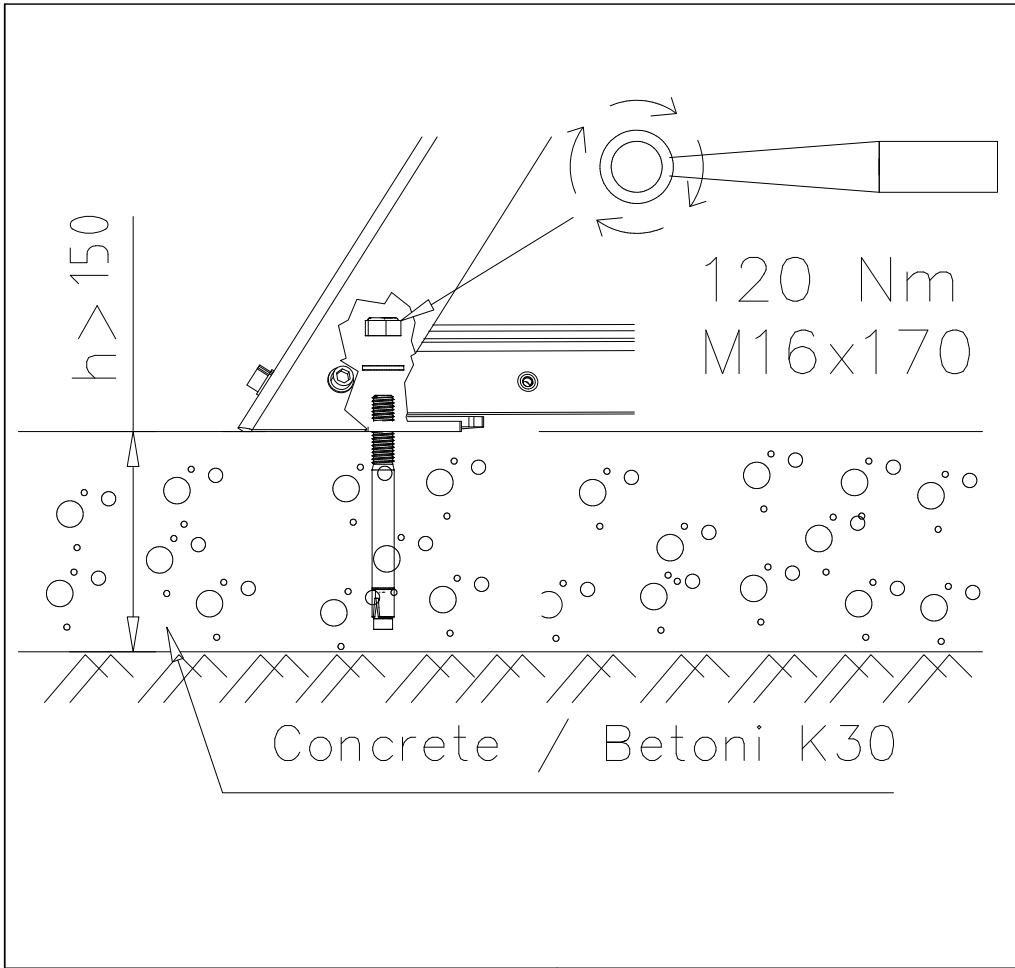

| | | | |
|---|-----|--|-----|
| ① 904450 | PCS | | PCS |
|  | 4 | | |
| M16x170 | | | |
| | PCS | | PCS |
| | | | |
| | PCS | | PCS |
| | | | |
| | PCS | | PCS |
| | | | |

