

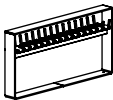

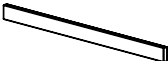

	ITEM CODE	DESCRIPTION	DIMENSION	QTY.
	914428	FRAME	90x458x916	2
	711773	PLANK	42x120x1800	16
	914420	SUPPORT PLATE	67x109x886	1
	980123	SPECIAL SCREW	Ø7x60	80
	702286	PRINTED LABEL	65x65	1
	909506	SCREW	Ø3,5x13	4



STEP 1

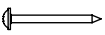
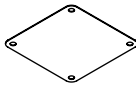

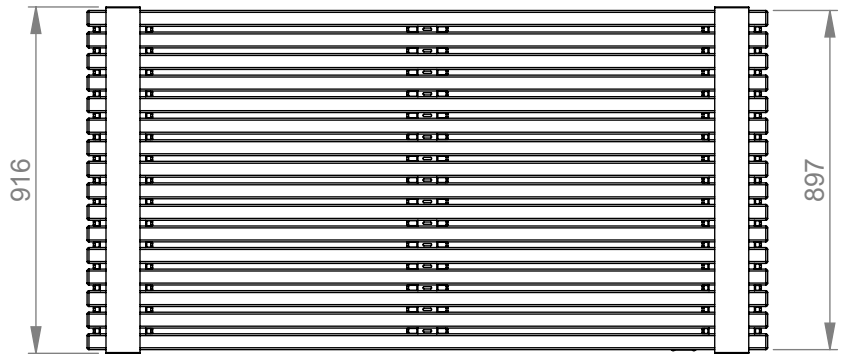
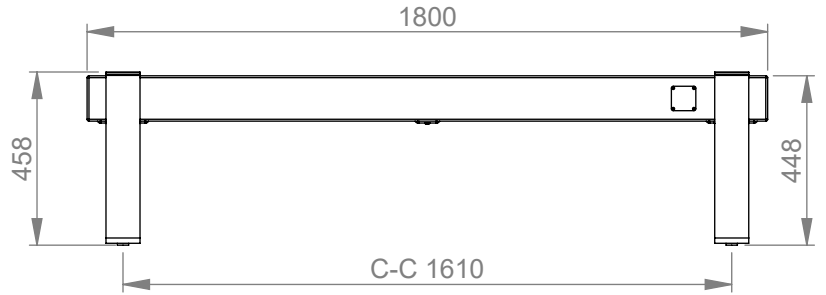
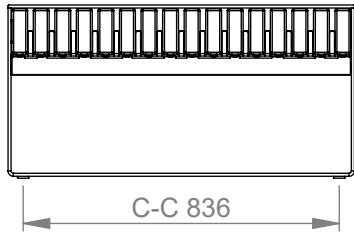
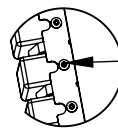
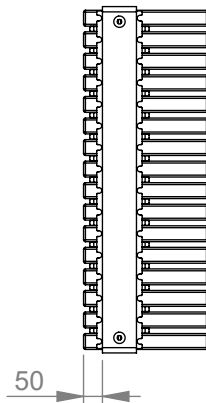
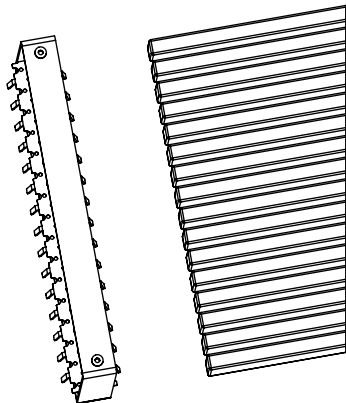
980123 32pcs ϕ 7x60

DETAIL A 1 : 10

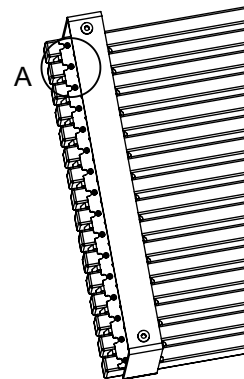

STEP 2

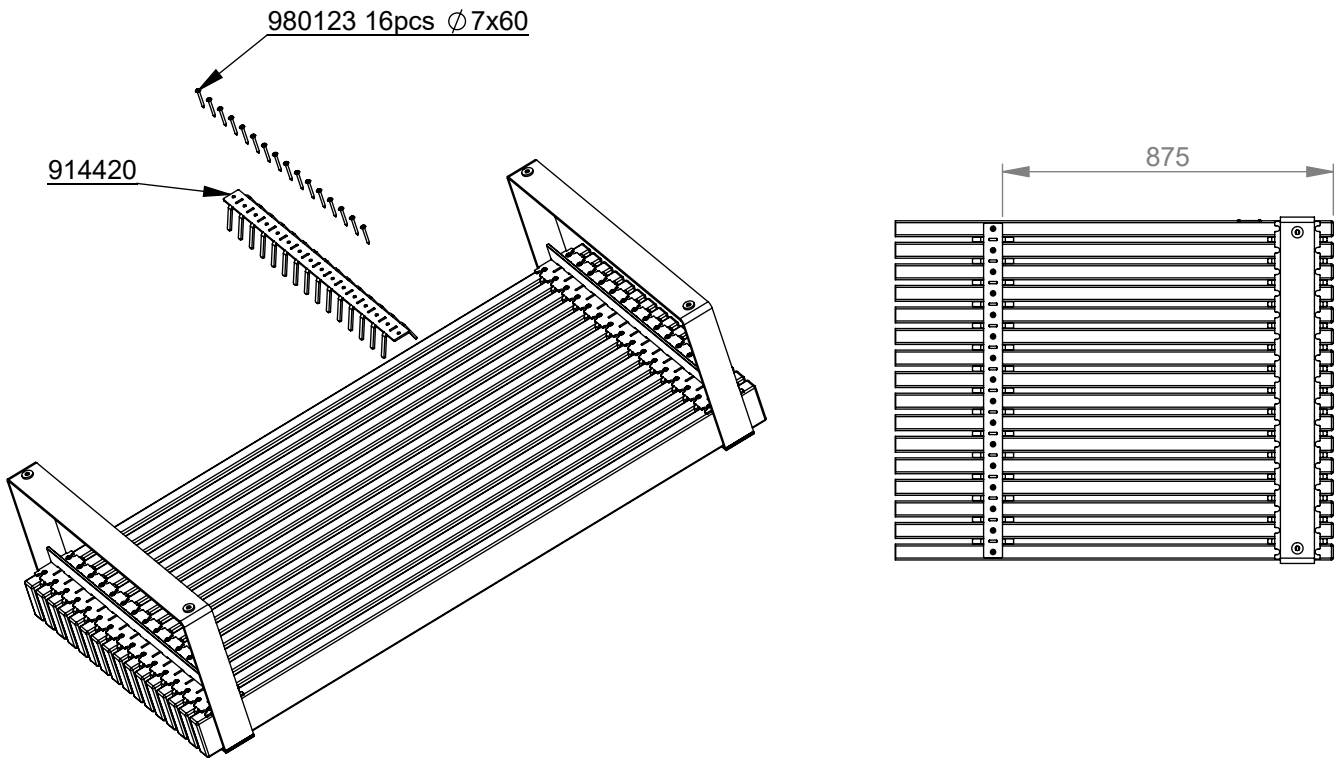

STEP 3

